

The LA7221 is an electronic switch that was designed for use in audio video applications. It provides a wide dynamic range. The LA7221 has on-chip video clamp circuits (clamp elimination function).

Features

- Low-voltage (5V) operation.
- Three inputs selectable and muting function.
- Video clamp circuits on chip.
- Wide dynamic range (2.0Vp-p or greater).

Maximum Ratings at $T_a = 25^\circ\text{C}$

			unit
Maximum Supply Voltage	$V_{CC \text{ max}}$	7.0	V
Allowable Power Dissipation	$P_d \text{ max}$	100	mW
Operating Temperature	T_{op}	-10 to +70	$^\circ\text{C}$
Storage Temperature	T_{stg}	-40 to +125	$^\circ\text{C}$

Operatings Characteristics at $T_a = 25^\circ\text{C}$, $V_{CC} = 5.0\text{V}$

		min	typ	max	unit
Operating Voltage	$V_{CC \text{ op}}$	4.5	5.0	6.2	V
Current Dissipation	I_{CC}	3.5	4.6	6.6	mA
Maximum Input Level	$V_{IN \text{ max}}$	2.0	2.2		Vp-p
Frequency Characteristic	G_F		0	± 0.5	dB
Total Harmonic Distortion	THD		0.03	0.1	%
Crosstalk	CT		-70	-60	dB
Crosstalk Appearing in Muting Circuit	CT_m		-60	-50	dB
Output DC Offset	ΔV_{OUT}		5	15	mV
CTL Changeover Level	V_{CTL}	1.0	1.4	1.8	V
Differential Gain	DG		0.5	1.0	%
Differential Phase	DP		0.5	1.0	deg

Block Diagram and Application Circuit

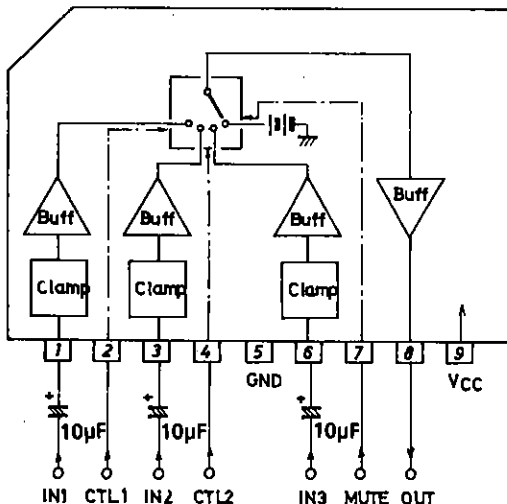

Truth Table

CTL.1	H	L	-	L
CTL.2	L	H	-	L
MUTE CTL	L	L	H	L
OUT	IN 1	IN 2	DC	IN 3

*: The output is indeterminate at other states than shown above.

Package Dimensions

(unit : mm)

3017C

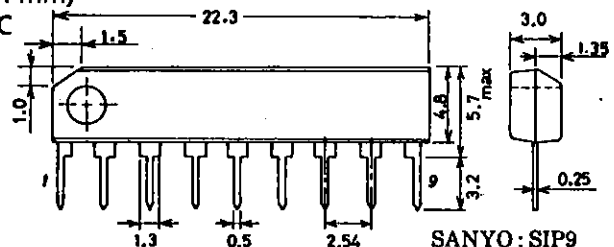

SANYO Electric Co., Ltd. Semiconductor Business Headquarters

TOKYO OFFICE Tokyo Bldg., 1-10, 1 Chome, Ueno, Taito-ku, TOKYO, 110 JAPAN

LA7221

LA7221 Input / Output Configuration

Unit (resistance:Ω)

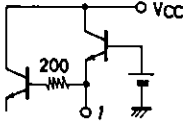
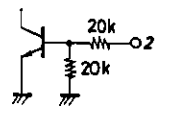
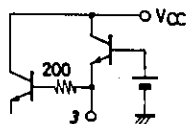
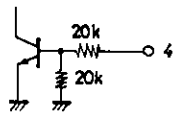
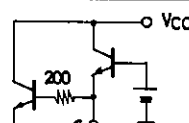
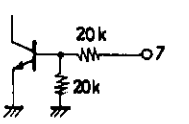
Pin	Name	I/O Impedance or I/O Configuration	DC Voltage	Remarks
1	IN1	∞	 2.4V	
2	CONTROL 1	∞	 0V	ON at 2.0V or greater
3	IN2	∞	 2.4V	
4	CONTROL 2	∞	 0V	ON at 2.0V or greater
5	GND		0V	
6	IN3	∞	 2.4V	
7	MUTE CONTROL	∞	 0V	ON at 2.0V or greater
8	OUT	20Ω	Emitter follower	Collector current 1.6mA
9	Vcc		5.0V	

■ No products described or contained herein are intended for use in surgical implants, life-support systems, aerospace equipment, nuclear power control systems, vehicles, disaster/crime-prevention equipment and the like, the failure of which may directly or indirectly cause injury, death or property loss.

■ Anyone purchasing any products described or contained herein for an above-mentioned use shall:

- ① Accept full responsibility and indemnify and defend SANYO ELECTRIC CO., LTD., its affiliates, subsidiaries and distributors and all their officers and employees, jointly and severally, against any and all claims and litigation and all damages, cost and expenses associated with such use;
- ② Not impose any responsibility for any fault or negligence which may be cited in any such claim or litigation on SANYO ELECTRIC CO., LTD., its affiliates, subsidiaries and distributors or any of their officers and employees jointly or severally.

■ Information (including circuit diagrams and circuit parameters) herein is for example only; it is not guaranteed for volume production. SANYO believes information herein is accurate and reliable, but no guarantees are made or implied regarding its use or any infringements of intellectual property rights or other rights of third parties.

This catalog provides information as of **December, 1996**. Specifications and information herein are subject to change without notice.