

SANYO

No.2393

LA3450

PLL FM MPX STEREO DEMODULATOR WITH ADJUSTMENT-FREE VCO
AND MEASURE AGAINST ADJACENT CHANNEL INTERFERENCE

The LA3450 is a multifunctional, high-performance FM multiplex demodulator IC designed for high-grade FM stereo tuner use. The LA3450 features adjustment-free VCO, measure against adjacent channel interference, pilot canceler, low distortion (0.005%), and high S/N (101dB).

Use

Home stereo, CD, AV-use PLL FM MPX stereo demodulator IC with adjustment-free VCO

Functions

- . PLL multiplex stereo demodulator
- . Adjustment-free VCO
- . Measure against adjacent channel interference
- . Pilot canceler
- . Cal-tone signal generator
- . AM/FM input, AM/FM selector
- . Post amp (gain variable type)
- . VCO stop
- . Right/left independent adjustment of separation (single adjustment available)

Features

- . Adjustment-free VCO: Eliminates the need to adjust free-running frequency.
- . Good temperature characteristics of VCO: $\pm 0.1\%$ typ. for $\pm 50^{\circ}\text{C}$ change
- . No antibirdie filter is required because a measure is taken against adjacent channel interference.
- . Less carrier leak 19kHz: 53dB 38kHz: 50dB
- . The on-chip cal-tone signal generator facilitates application of recording calibrator.
- . Low distortion MONO 0.005% STEREO 0.015%
- . High S/N 101dB typ. MONO IHF-A BPF
- . High voltage gain FM: 10dB (gain variable)
AM: 16dB (gain variable)
- . Wide dynamic range Output level 3.3V typ. (THD=1%, MONO)

Package Dimensions 3063-D28SNIC
(unit: mm)

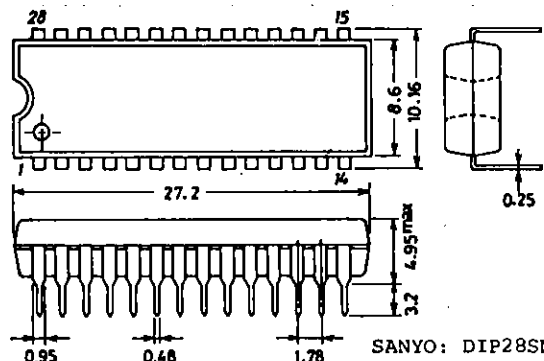

SANYO Electric Co., Ltd. Semiconductor Business Headquarters
TOKYO OFFICE Tokyo Bldg., 1-10, 1 Chome, Ueno, Taito-ku, TOKYO, 110 JAPAN

LA3450

Maximum Ratings at Ta=25°C			unit
Maximum Supply Voltage	V _{CCmax}	16	V
Lamp Drive Current	I _{Lmax}	30	mA
Allowable Power Dissipation	P _{Dmax}	680	mW
Operating Temperature	T _{opr}	-20 to +70	°C
Storage Temperature	T _{stg}	-40 to +125	°C

Operating Conditions at Ta=25°C			unit
Recommended Supply Voltage	V _{CC}	13	V
Operating Voltage	V _{CCop}	10 to 15	V
Recommended Input Signal Voltage	V _i	400	mV

Electrical Characteristics at Ta=25°C, V _{CC} =13V, Input: 400mV, f=1kHz, L+R=90%, PILOT=10%						
			min	typ	max	unit
Quiescent Current	I _{cco}	No input		29	39	mA
Input Resistance	r _i	FM, AM input common	14	20	26	kohm
Channel Separation	Sep	f=100Hz		50		dB
		f=1kHz	45	60		dB
		f=10kHz		50		dB
Total Harmonic Distortion THD	THD	FM MONO	0.005	0.05		%
		MAIN	0.015	0.08		%
		AM 200mV input	0.02	0.08		%
Allowable Input Level	V _{in max}	FM MONO, THD=1%	800	1200		mV
		AM	400	600		mV
Output Voltage	V _o	FM MONO	770	1100	1500	mV
		AM 200mV input	770	1100	1500	mV
Signal to Noise Ratio	S/N	MONO IHF-A BPF	90	101		dB
Birdie Noise Rejection	BR	Spurious signal, V _S =100mV, f _s =115kHz		40		dB
19kHz Carrier Leak	CL ₁₉	Canceler, de-emphasis		53		dB
38kHz Carrier Leak	CL ₃₈	De-emphasis		50		dB
Crosstalk	CT	AM→FM, AM input 200mV	70	80		dB
		FM→AM, FM input 400mV	70	80		dB
Channel Balance	CB	FM MONO		0	1	dB
Cal-tone OSC Frequency				400		Hz
AM/FM Select Voltage	V _{AM-FM}	AM→FM, voltage applied to pin26			0.5	V
		FM→AM, "		2.5		V
VCO Stop Voltage		Voltage applied to pin10	2.5			V
Lamp Lighting Level	V _L	PILOT LEVEL	4	7.5	13	mV
Lamp Hysteresis	hy			3.5		dB
Capture Range(Note 1)		PILOT 30mV		±1.2		%

(Note 1) : The capture range is represented by the value in 19kHz equivalent.



(Note 2) : The low-pass filter used to measure electrical characteristics must have 19kHz attenuation of -90dB or more negative value of dB and 38kHz attenuation of -70dB or more negative value of dB.

(Note 3) : Be carefull that the combination of pin 22 ⊕ and the others causes dielectric breakdown easily.

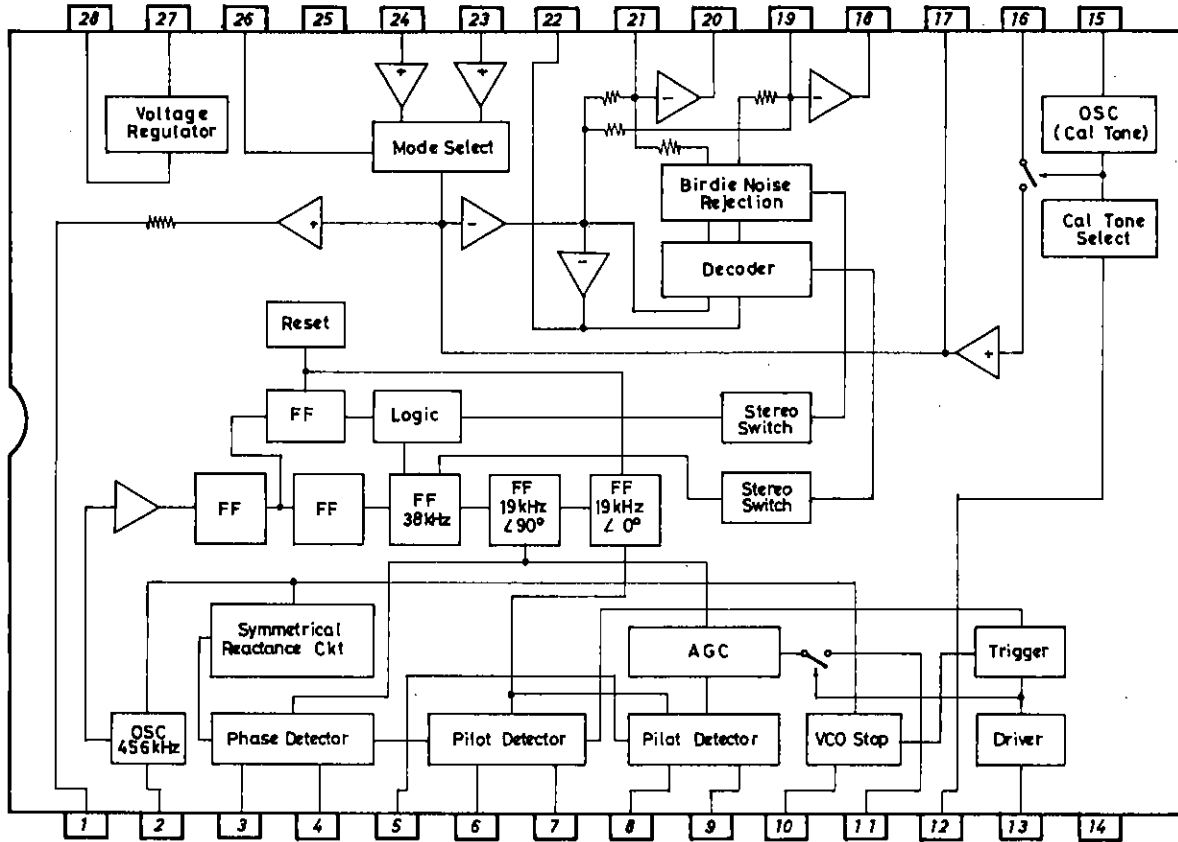
Internal Block Diagram

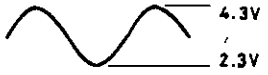

Typical Value of Voltage on Each Pin and Pin Name

Pin No.	Typ. Value	Pin Name	Remarks
1	5.7V	Composite amp output	Output resistance 1kohm
2	-	OSC	 4.3V 2.3V f=456kHz
3	2.6V	Loop filter	
4	2.6V	Loop filter	
5	2.6V	PLL input	
6	2.6V	Pilot sync detection filter	
7	2.6V	"	
8	2.6V	"	For pilot cancel
9	2.6V	"	"
10	-	VCO stop	Input resistance 120kohm
11	-	Pilot cancel	Triangular wave output, level follow-up
12	3.8V	Cal-tone control	Pin voltage is represented by voltage at ON state.
13	-	Stereo indicator	Open collector
14	0	GND	
15	-	Cal-tone OSC output	 2.8V 1.2V f=400Hz
16	5.7V	Cal-tone input	
17	5.7V	Pilot cancel input	

Continued on next page.

Continued from preceding page.

Pin No.	Typ. Value	Pin Name	Remarks
18	5.7V	Post amp output	L output
19	5.7V	Post amp input	L input, (-) input
20	5.7V	Post amp output	R output
21	5.7V	Post amp input	R input, (-) input
22	5.7V	Separation adjustment	
23	5.7V	AM input	Input resistance 20kohms
24	5.7V	FM input	Input resistance 20kohms
25	0	Signal GND	
26	-	AM/FM selection	Input resistance 120kohms
27	5.7V	Vref	Reference voltage
28	Vcc	Power supply	

Sample Application Circuit (1)
Input separation ≥ 0.92

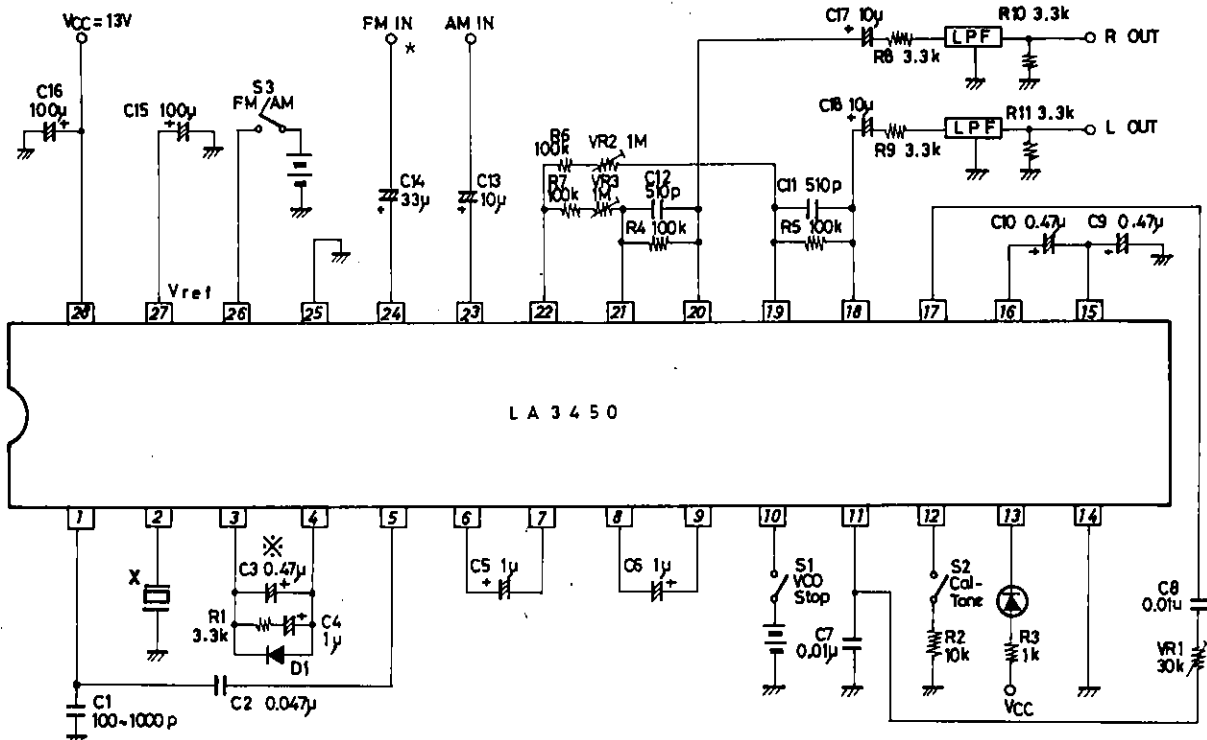

Unit (resistance: Ω, capacitance: F)

- X: CSB456F11 (Murata)
KBR-457HS (Kyocera)
- ※: Input pilot level 20mV or greater: 0.47µF
14mV or greater: 0.22µF
8mV or greater: C3=0.1µF, R1=6.8kohms, C4=0.47µF
- *: Input separation (sub signal/main signal) ≥ 0.92 (f=1kHz)

How to Make Single Adjustment of Separation

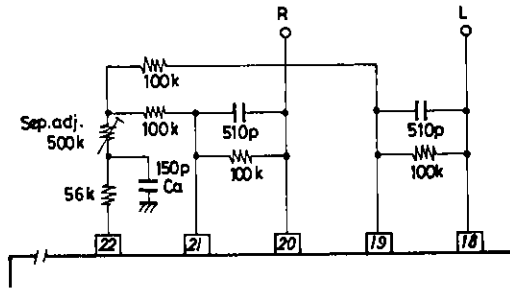

Unit (resistance: Ω, capacitance: F)

Sample Application Circuit (2)
Input separation ≥ 0.92

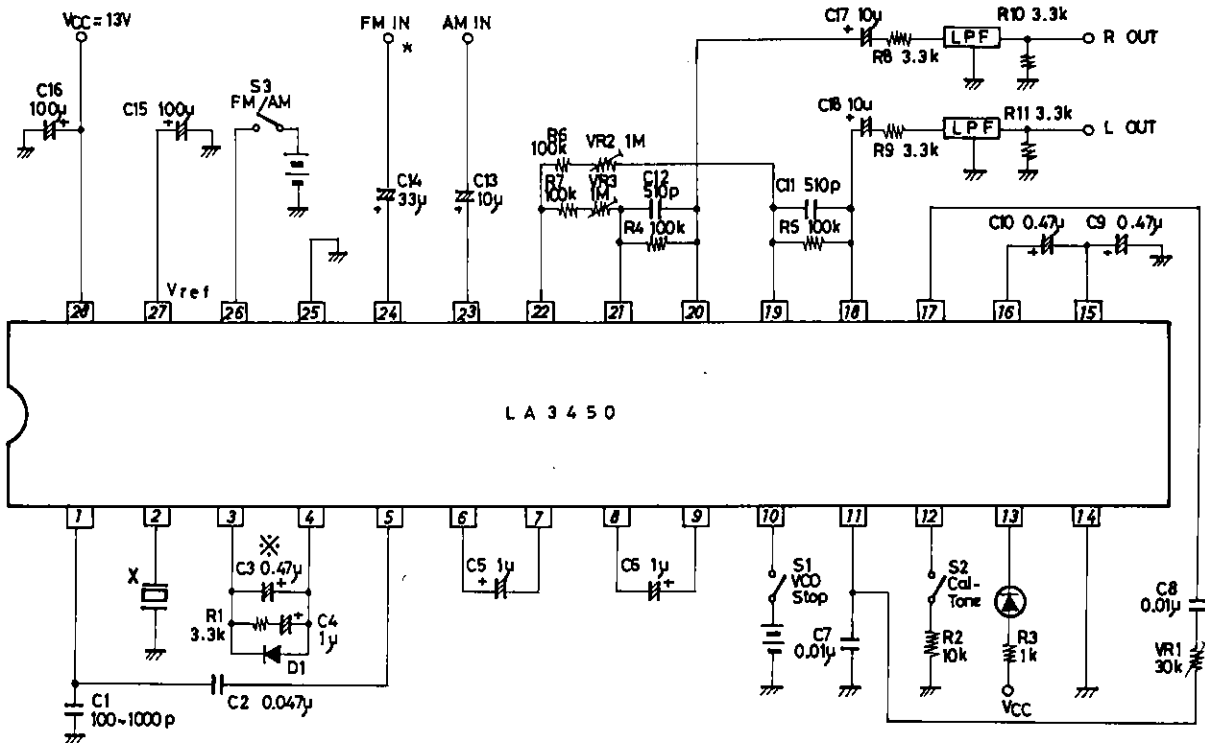

Unit (resistance: Ω, capacitance: F)

X: CSB456F11 (Murata)
KBR-457HS (Kyocera)

※: Input pilot level 20mV or greater: 0.47μF
14mV or greater: 0.22μF

8mV or greater: C3=0.1μF, R1=6.8kohms, C4=0.47μF

*: Input separation (sub signal/main signal) ≥ 0.92 (f=1kHz)

How to Make Single Adjustment of Separation

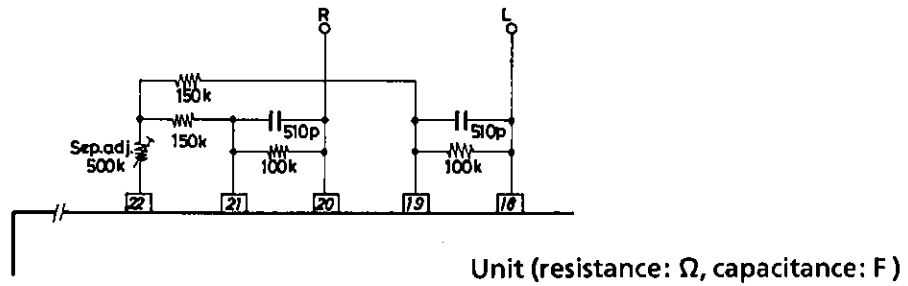

Sample Application Circuit (3)
Pilot sine wave cancel

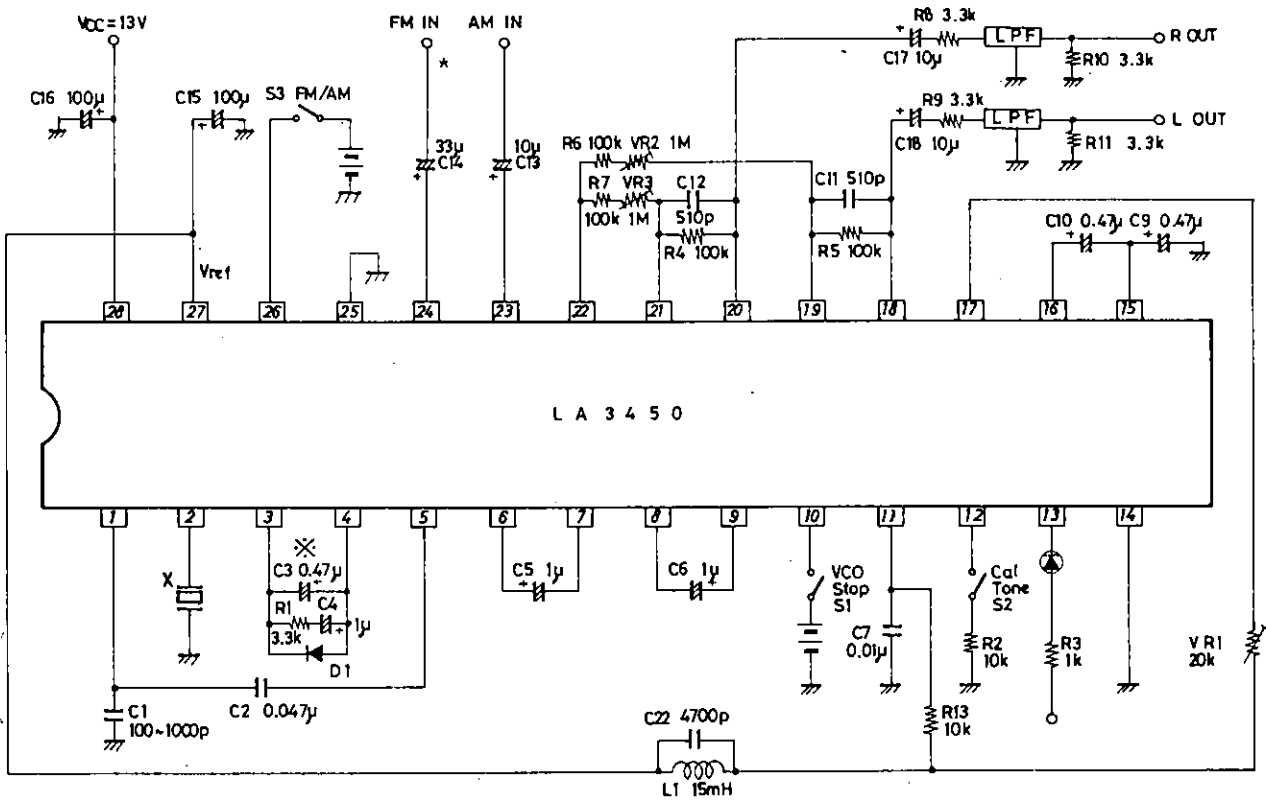

X: CSB456F11 (Murata)
KBR-457HS (Kyocera)

※: Input pilot level 20mV or greater: 0.47μF
14mV or greater: 0.22μF
8mV or greater: C3=0.1μF, R1=6.8kohms, C4=0.47μF

※: Input separation (sub signal/main signal) ≥ 0.92 (f=1kHz)
For the separation adjusting method when the input separation is more than 0.92, see Sample Application Circuit (2).

(Note 1) In this Sample Application Circuit, the DC voltage on pins 11, 17 is almost equal to that on pin 27 and no DC cut capacitor (C8 in Sample Application Circuits (1), (2)) is required.

Description of External Parts

Name	Symbol	Kind	Value	Remarks	
Capacitor	C1	Ceramic	100to1000pF (Note1)	Improvement in stereo low-frequency distortion	
	C2	Polyester film	0.047uF	DC cut	
	C3	Electrolytic	0.1 to 0.47uF	Loop filter, Input pilot 8mV or greater: 0.1uF " 14mV or greater: 0.22uF 20mV or greater: 0.47uF	
	C4	Electrolytic	0.47uF to 1uF	Loop filter, Input pilot 8mV or greater: 0.47uF " 14mV or greater: 1uF	
	C5	Electrolytic	1uF	Sync detection filter	
	C6	Electrolytic	1uF	Sync detection filter	
	C7	Polyester film	0.01uF	For integration (generation of triangular wave)	
	C8	Polyester film	0.01uF	DC cut	
	C9	Electrolytic	0.47uF	For integration (generation of triangular wave)	
	C10	Electrolytic	0.47uF	DC cut	
	C11to12	Ceramic	510pF	De-emphasis capacitor, R5.C11=50us(75us) R4.C12=50us(75us)	
	C13	Electrolytic	10uF	DC cut	
	C14	Electrolytic	33uF	DC cut	
	C15	Electrolytic	100uF	Filter, S/N improvement	
	C16	Electrolytic	100uF	Power filter	
	C17to18	Electrolytic	10uF	DC cut	
	C19	Ceramic	1000pF	LPF for sub signal attenuation	
	C20to21	Ceramic	100pF	Improvement in separation at high frequencies (Note2)	
	C22	Ceramic	4700pF	19kHz tank circuit (generation of sine wave)	
	Resistors	R1	Carbon	3.3 to 6.8k ohms	Loop filter, Input pilot 8mV or greater: 6.8kohms " 14mV or greater: 3.3kohms
		R2	Carbon	10kohms	Fixing of cal-tone OSC frequency
		R3	Carbon	1kohm	Limiting resistor
R4to5		Carbon	100kohms	Post amp feedback resistor, de-emphasis resistor	
R6to7		Carbon	100kohms	For separation adjustment	
R8to9		Carbon	3.3kohms	LPF input resistor (Note3)	
R10to11		Carbon	3.3kohms	LPF output resistor	
R12		Carbon	2kohms	LPF for sub signal attenuation	
R13		Carbon	10kohms	Generation of pilot cancel signal	
Semifixed resistor		VR1	Carbon	30kohms	Pilot cancel adjustment
		VR2to3	Carbon	1Mohm	Separation adjustment
Resonator		X	Ceramic		CSB456F11(Murata), KBR-457HS(Kyocera)
Diode		D ₁	Silicon(Low leak)		Improvement in stereo start time after VCO stop release
Coil	L ₁		15mH	19kHz tank circuit (generation of sine wave)	

Note1: C1 differs with set models. Capacitor used to phase the sub signal of the decoder with the reproduction sub signal in the PLL.

Note2: C20 to 21 are set to the optimum value according to each set model.

Note3: The LPF input resistor value is 3.3kohms or greater.

Sample Printed Circuit Pattern

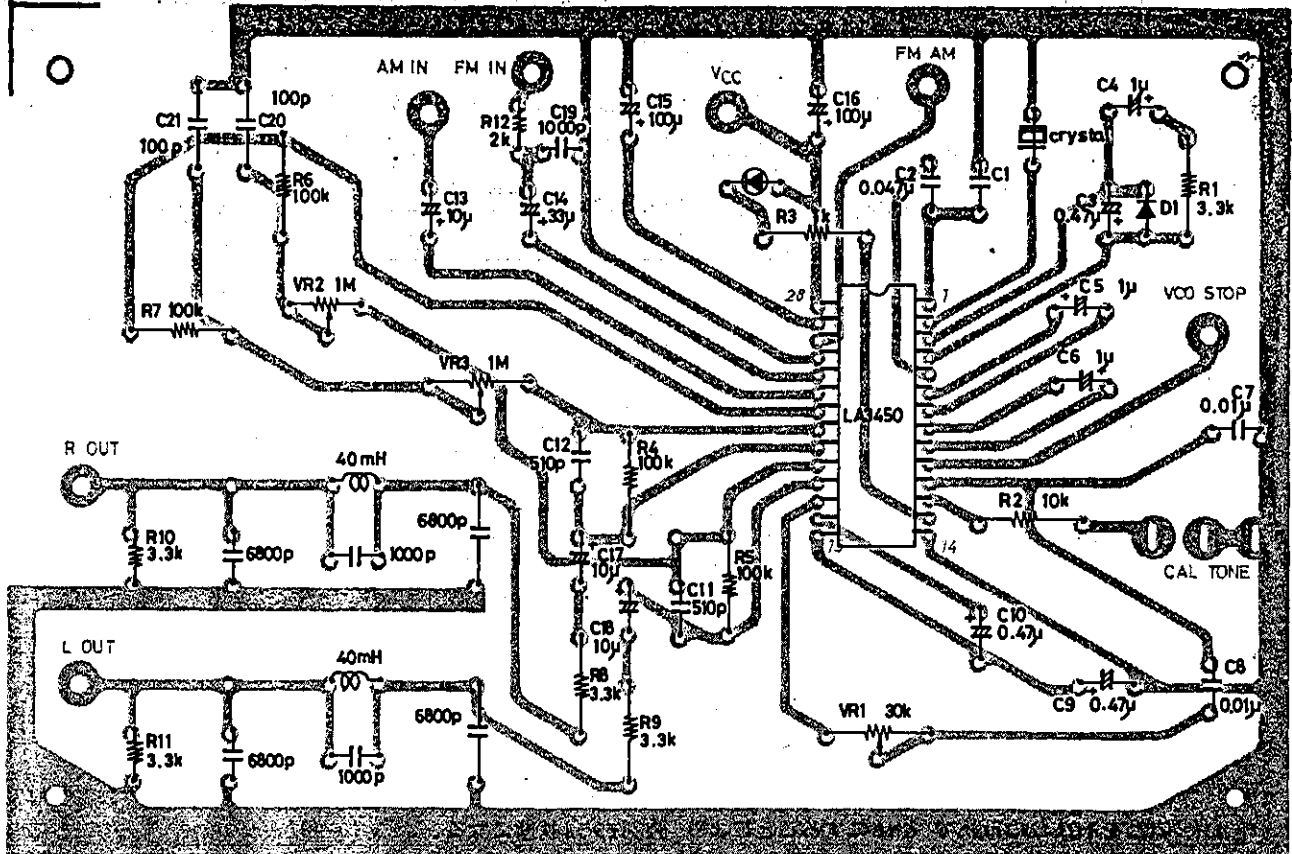

8.5 x 13.0 mm²

Unit (resistance: Ω, capacitance: F)

Proper Cares in Applications

1. Ceramic resonator

Shown below are ceramic resonators recommended for use in the LA3450 and their suppliers.

CBS456F11	Murata	Piezoelectric Division
		TEL: 0762-40-2381
KBR-457HS	Kyocera	Electronic Parts Division
		TEL: 075-592-3851

2. Loop filter constants

Loop filter constants (C3, C4, R1) connected to pins 3,4 must be set to the optimum value according to an input pilot level. The recommended values are shown in Table 1.

Input Pilot Level	C3	C4	R1
20mV or greater	0.47μF	1μF	3.3kohms
14mV or greater	0.22μF	1μF	3.3kohms
8mV or greater	0.1μF	0.47μF	6.8kohms

Table 1. Input Pilot Level - Loop Filter Constants

Note: For example, when the loop filter constants are C3=0.22μF, C4=1μF, R1=3.3kohms, stereo operation can be performed with an input pilot level of 14mV or greater, even with the temperature characteristics of the OSC circuit, the initial tolerance and secular change of a ceramic resonator considered.

3. VCO stop method

VCO OSC can be stopped and the forced monaural mode is entered by applying a voltage of 2.5V or greater to pin 10. The maximum voltage to be applied to pin 10 is 16V regardless of the voltage on pin 28 (V_{CC} pin). The relation between applied voltage and flow-in current is shown in Fig.1.

Fig.1. Voltage Applied to pins 10,26 - Flow-in Current

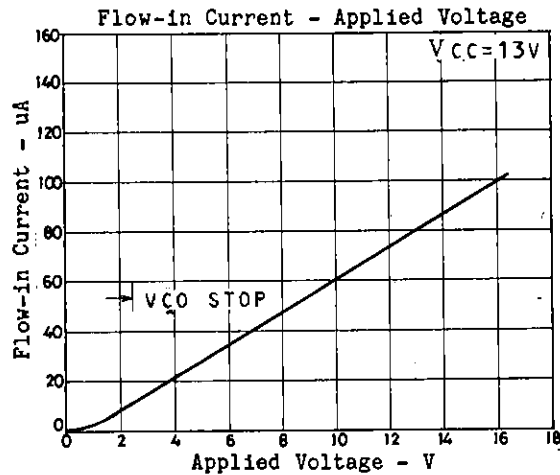

4. Forced monaural mode

Connecting pin 16 to GND through a resistor of 10kohms causes the forced monaural mode to be entered.

5. AM/FM mode select method

The AM/FM mode can be selected by applying a voltage to pin 26. When the voltage on pin 26 is 0.5V or less, the FM mode is entered, and when 2.5V or greater, the AM mode is entered. In AM mode the VCO stops and the forced monaural mode is entered. The relation between voltage on pin 26 and flow-in current is as shown in Fig.1.

6. Separation adjust method

The separation is adjusted by varying the gain of the main signal with VR2, VR3 as shown in the Sample Application Circuit. Sample Application Circuit (1) or (2) is used according to the attenuation of the input sub signal. When the attenuation ratio of the sub signal to the main signal is 0.92 or greater to 1, use Sample Application Circuit (1), and when 0.92 or less to 1, use Sample Application Circuit (2). Capacitors C20 and C21, which are used to improve the separation characteristic at high frequencies, must be set to the optimum values according to your model set.

7. Cal-tone

The OSC frequency can be set with R2, C9 in the Sample Application Circuit (refer to Fig.2). The OSC level can be attenuated on connecting resistor Rx across pin 15 and pin 16 (refer to Fig.3). When the S2 is turned on, the triangular wave generated on pin 15 is amplified by the post amp and output. The level at pins 18, 20 is approximately 4V(p-p) when the typical constants are used in the Sample Application Circuit and the output level becomes approximately $4X20/(Rx+20)$ V(p-p) by connecting Rx.

Fig.2. OSC Frequency - R2, C9

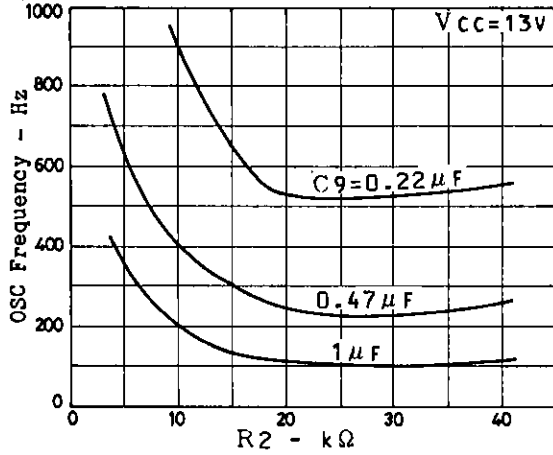
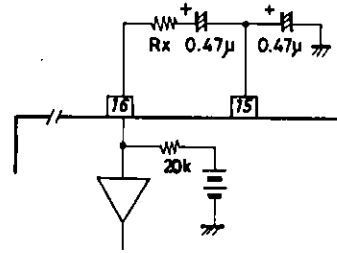

Fig.3. OSC Level Variable



Unit (resistance: Ω, capacitance: F)

8. $V_0 - I_0$ characteristic at pin 27

Fig.4 shows $V_0 - I_0$ characteristic at pin 27 (I_0 : Capable of being drawn to the outside)

Maximum current: 3mA

Fig.4. $V_0 - I_0$

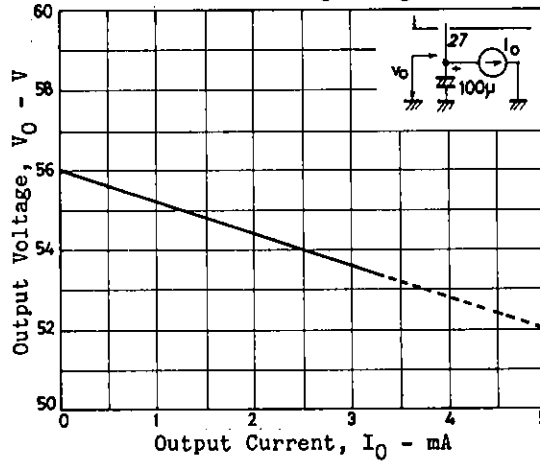

9. Feedback resistance of post amp and total gain, de-emphasis constants

Table 2 shows the feedback resistance of post amp and the total gain, de-emphasis constants.

Table 2. Feedback resistance of post amp and of total gain, de-emphasis constants

R4(R5)	Total gain	C12(C11) 50us	C12(C11) 50us
33kohms	0dB	1500pF	2200pF
39kohms	1.5dB	1200pF	2000pF
51kohms	4dB	1000pF	1500pF
62kohms	5.5dB	750pF	1200pF
82kohms	8dB	620pF	910pF
100kohms	10dB	510pF	750pF
130kohms	12dB	390pF	560pF
150kohms	13dB	330pF	510pF
180kohms	15dB	270pF	390pF

Total gain: At monaural mode

$$R4 \cdot C12 = R5 \cdot C11 = 50\mu s, 75\mu s$$

10. Low-pass filter

Figs.5, 6 show a sample circuit configuration and characteristic of the low-pass filter.

Fig.5. Sample Circuit of LC Filter

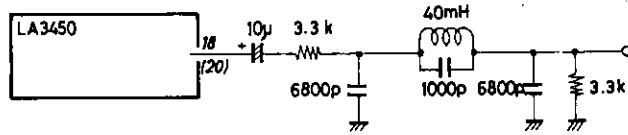

Loss of LPF: Approximately -6dB

Unit (resistance: Ω, capacitance: F)

Fig.6 f Response

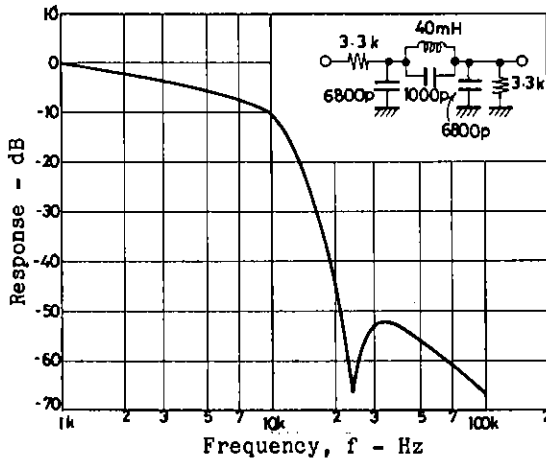

Note: As the use of this low-pass filter makes the attenuation less at 19KHz, 38KHz, carrier leak at the LPF output causes the stereo distortion and separation characteristics to get worse than specified in the Electric Characteristics. For example, the stereo distortion becomes approximately 0.5% due to carrier leak.

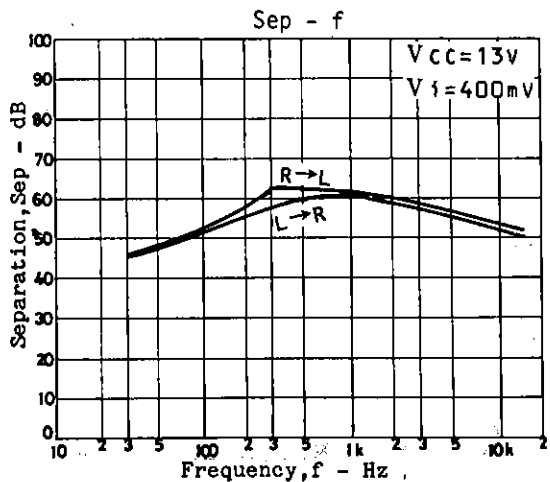
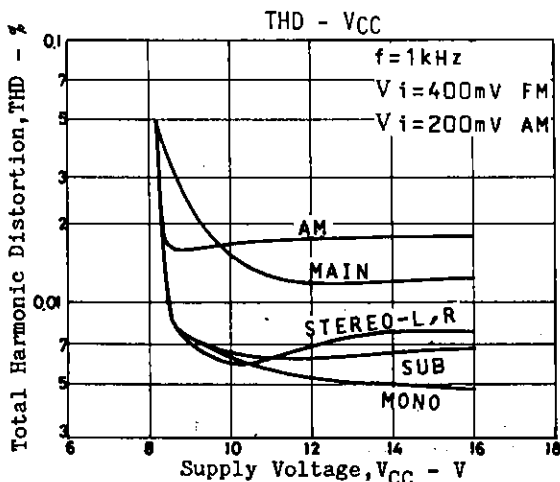
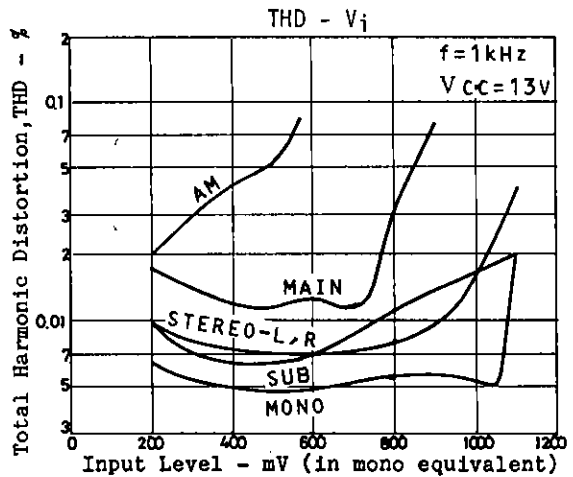
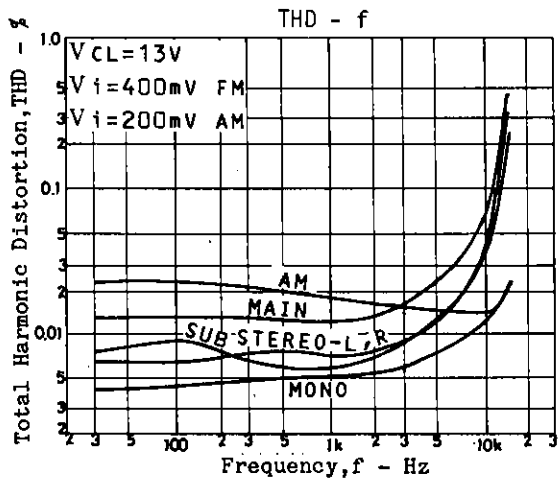
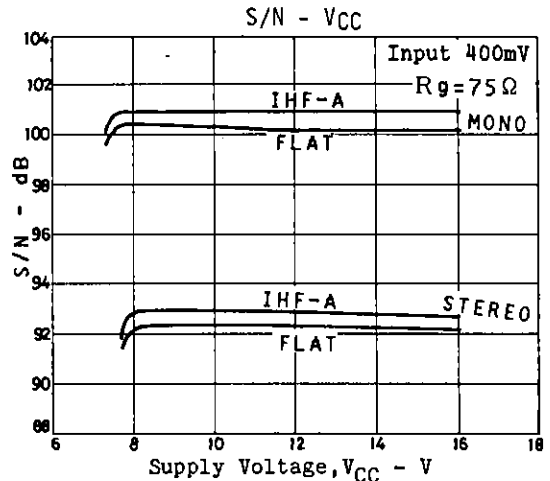
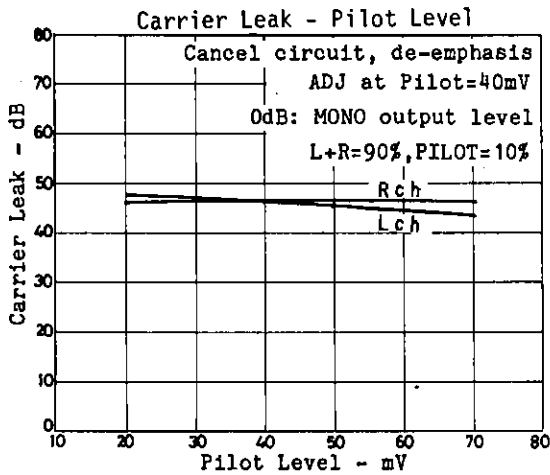
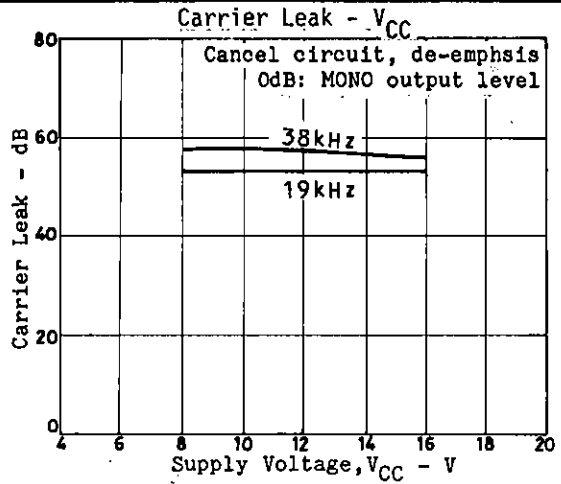
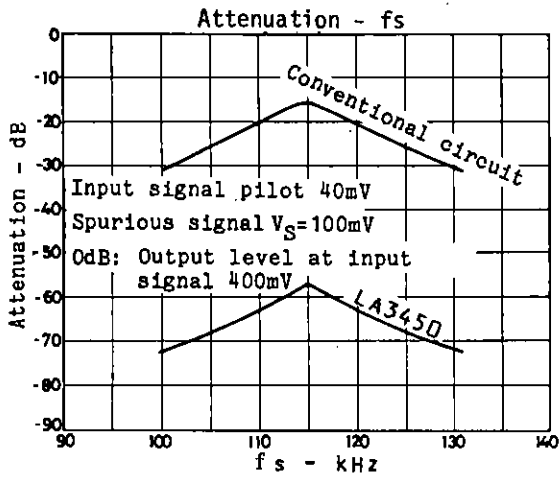

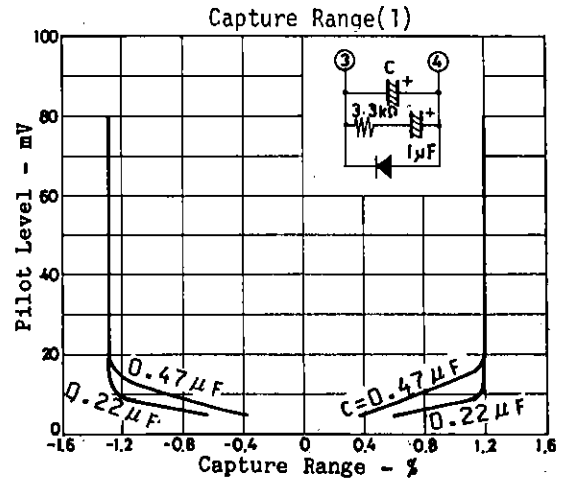
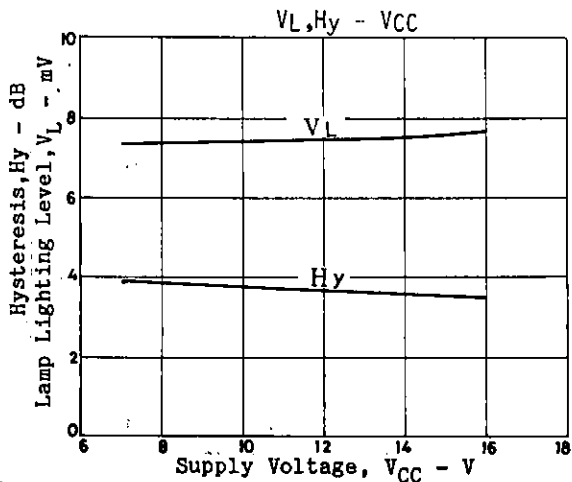
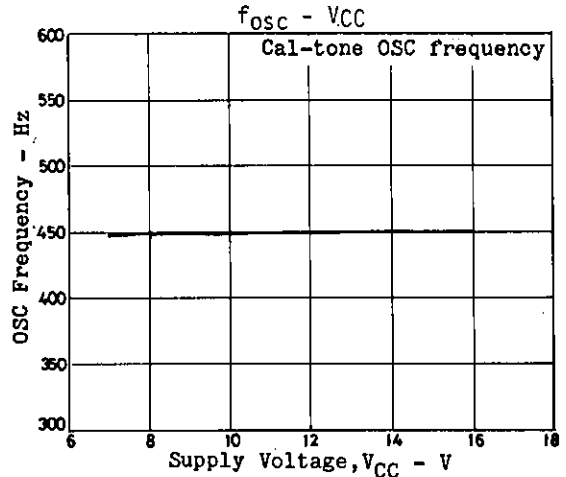
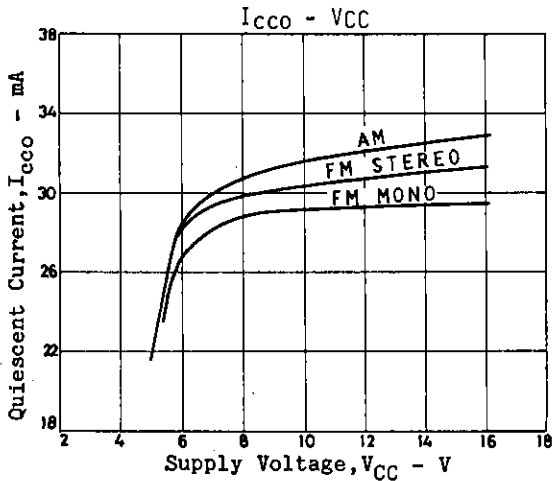
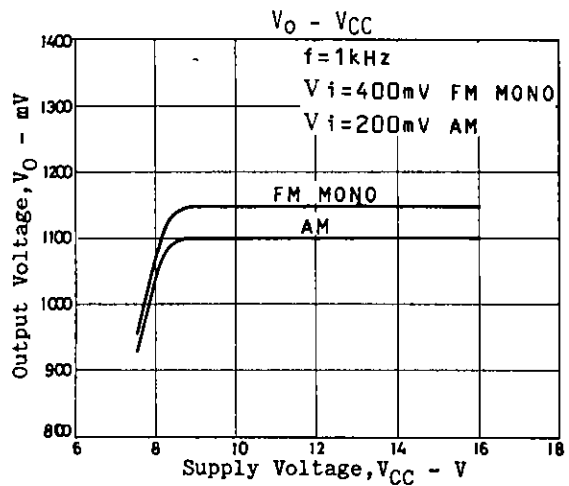
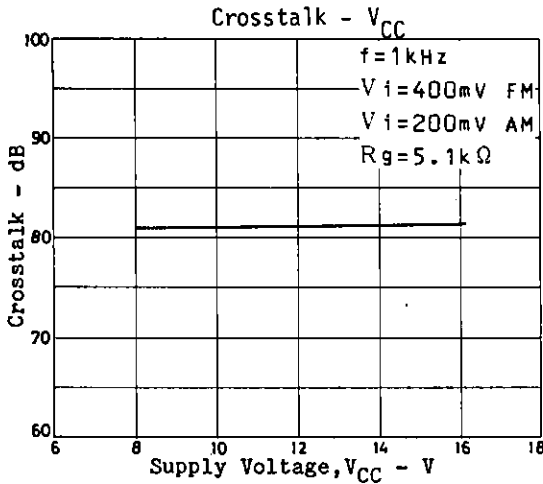
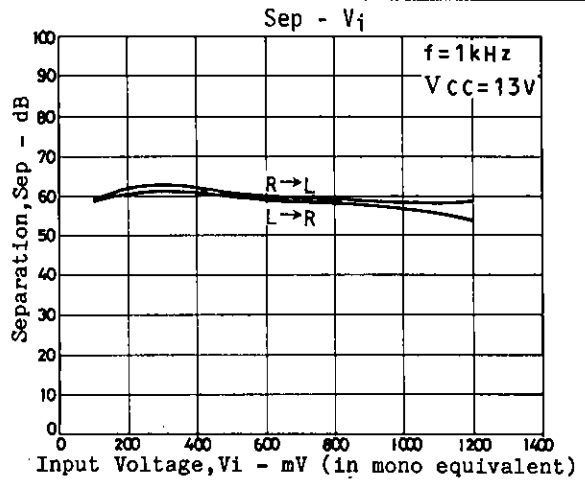
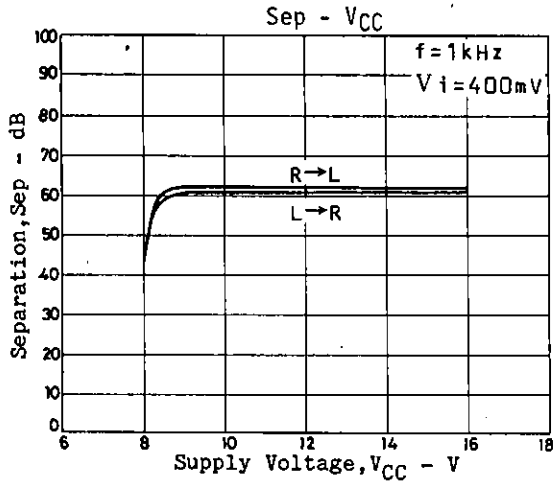

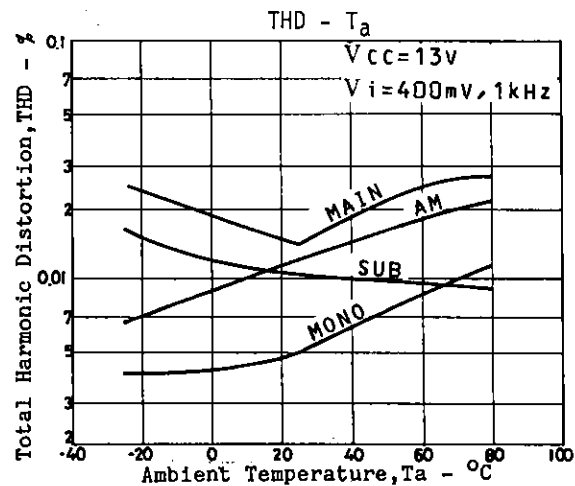
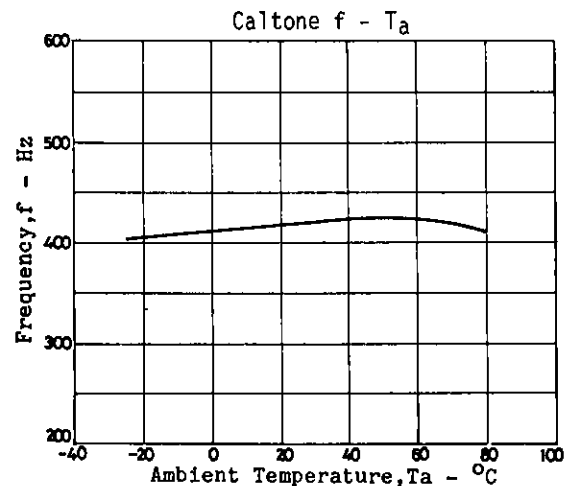
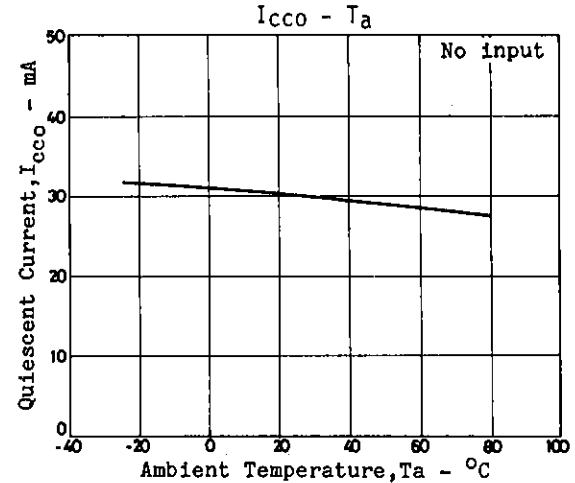
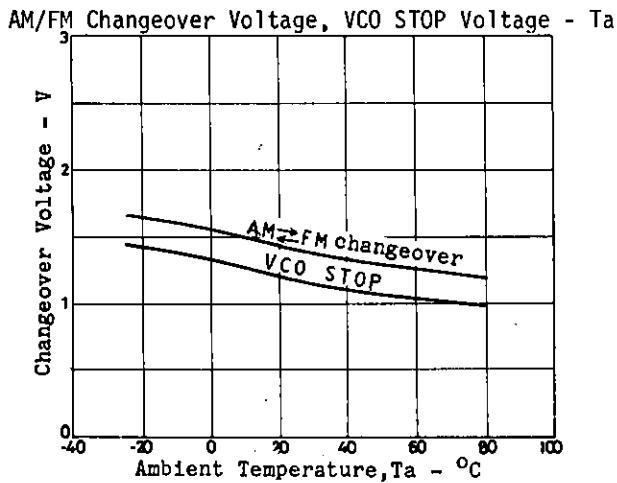
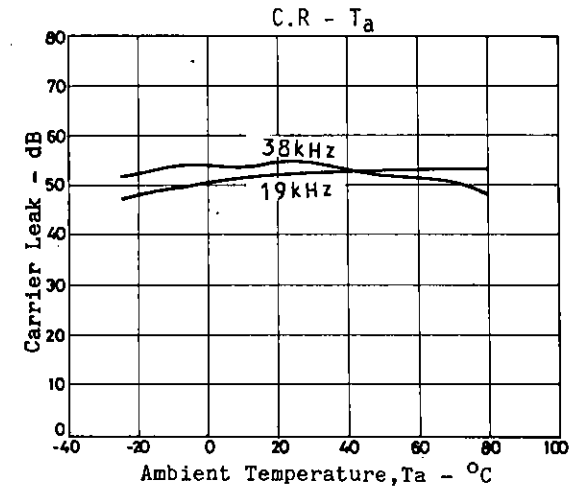
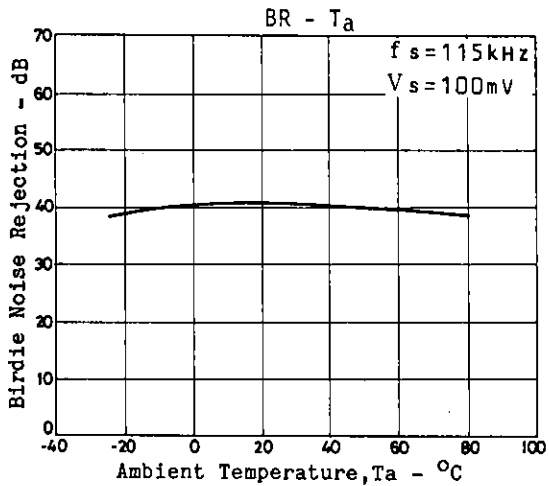
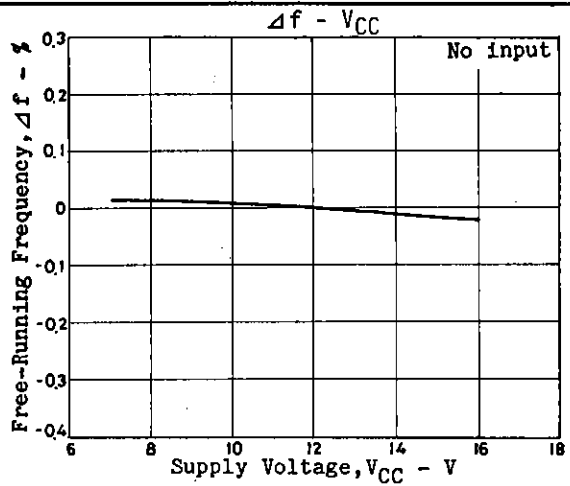
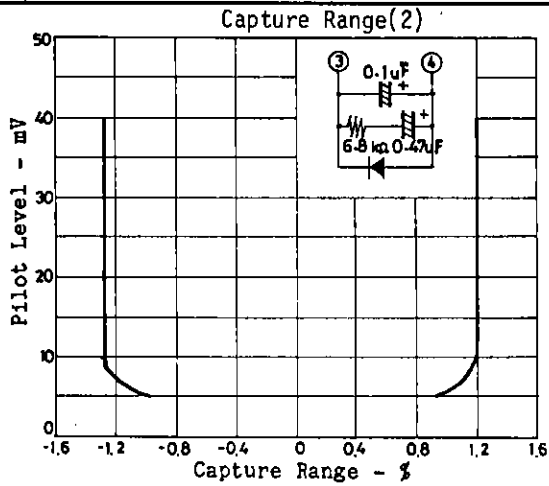

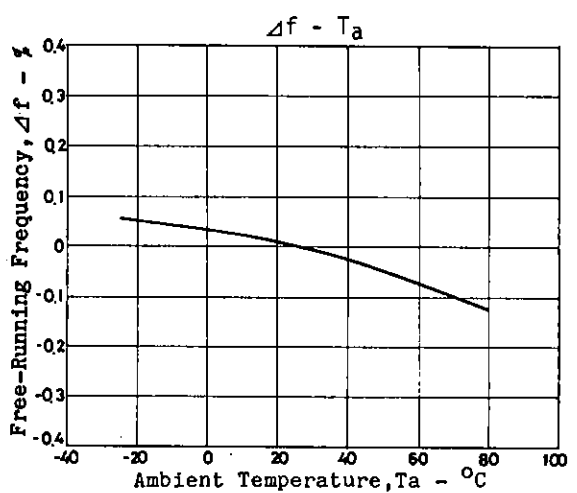
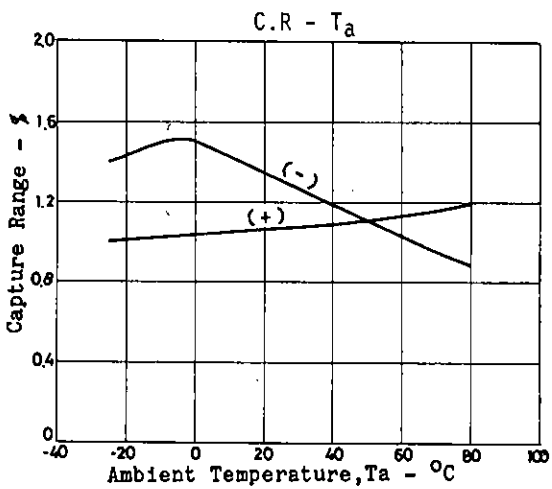
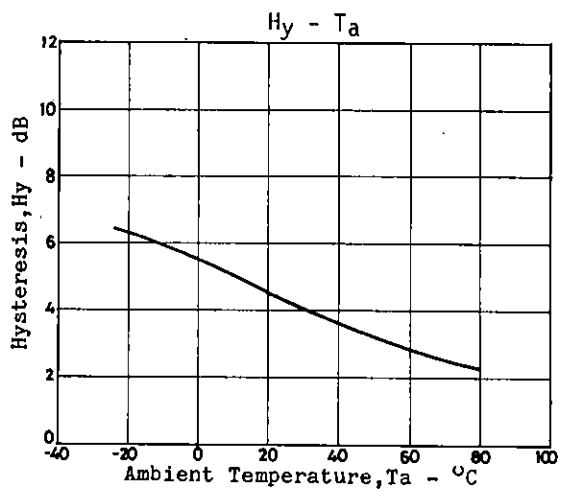
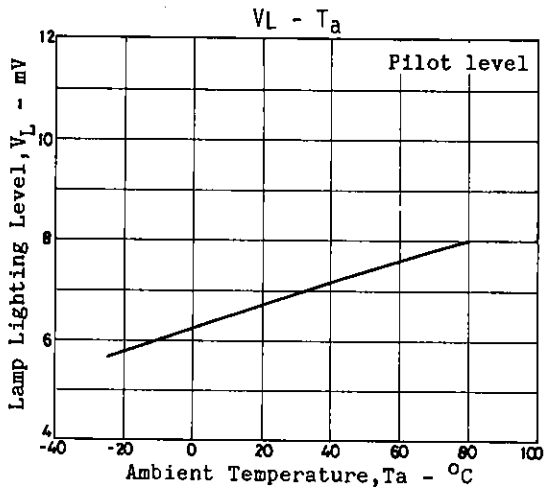
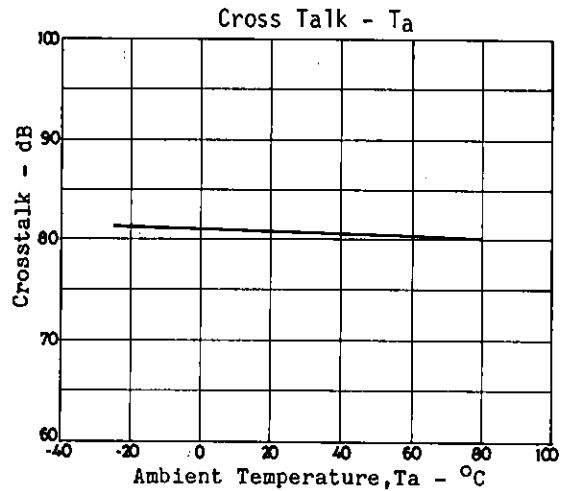
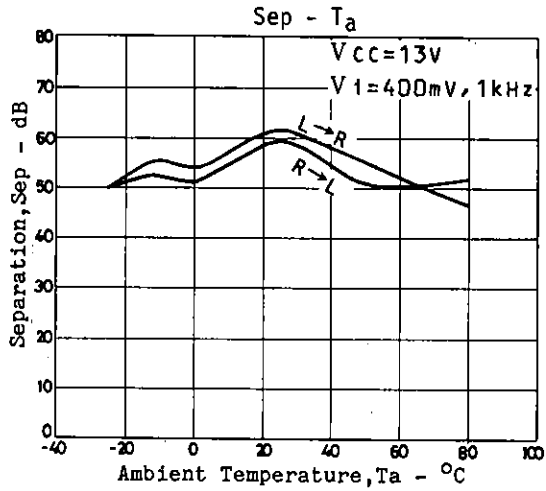

- No products described or contained herein are intended for use in surgical implants, life-support systems, aerospace equipment, nuclear power control systems, vehicles, disaster/crime-prevention equipment and the like, the failure of which may directly or indirectly cause injury, death or property loss.
- Anyone purchasing any products described or contained herein for an above-mentioned use shall:
 - ① Accept full responsibility and indemnify and defend SANYO ELECTRIC CO., LTD., its affiliates, subsidiaries and distributors and all their officers and employees, jointly and severally, against any and all claims and litigation and all damages, cost and expenses associated with such use:
 - ② Not impose any responsibility for any fault or negligence which may be cited in any such claim or litigation on SANYO ELECTRIC CO., LTD., its affiliates, subsidiaries and distributors or any of their officers and employees jointly or severally.
- Information (including circuit diagrams and circuit parameters) herein is for example only; it is not guaranteed for volume production. SANYO believes information herein is accurate and reliable, but no guarantees are made or implied regarding its use or any infringements of intellectual property rights or other rights of third parties.