

SANYO	No.2277A	LA3607
	7-Band Graphic Equalizer	

Features

- . 7-band graphic equalizer for one channel can be formed easily by externally connecting capacitors and variable resistors which fix fo (resonance frequency).
- . Series connection of the LA3607 makes multiband available.
- . Boost, cut amount can be varied by external resistors.
- . Highly stable to capacitive load

Maximum Ratings at Ta=25°C

			unit
Maximum Supply Voltage	V _{CCmax}	20	V
Allowable Power Dissipation	P _{dmax} LA3607	300	mW
Operating Temperature	T _{opr}	-20 to +75	°C
Storage Temperature	T _{stg}	-40 to +125	°C

Operating Conditions at Ta=25°C

			unit
Recommended Supply Voltage	V _{CC}	8	V
Operating Voltage Range	V _{CCop}	5 to 15	V

Operating Characteristics at Ta=25°C, V_{CC}=8V, R_L=10kohms, R_g=600ohms,

			min	typ	max	unit	
Quiescent Current	I _{cco} Quiescent	See specified Test Circuit.		7	9	mA	
Voltage Gain	VG f=1kHz, V _{IN} =-10dB at all flat mode		-3.8	-0.8	2.2	dB	
Boost Amount	BOOST	f=60Hz	}	10	12	14	dB
		f=150Hz		10	12	14	dB
		f=400Hz		10	12	14	dB
		f=1kHz		10	12	14	dB
		f=2.5kHz		10	12	14	dB
		f=6kHz		10	12	14	dB
		f=15kHz	10	12	14	dB	

Continued on next page.

**Package Dimensions
(unit: mm)
3021B**

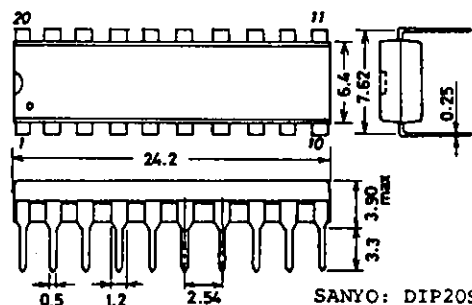

Continued from preceding page.

			min	typ	max	unit
Cut Amount	CUT	f=60Hz	-14	-12	-10	dB
		f=150Hz	-14	-12	-10	dB
		f=400Hz	-14	-12	-10	dB
		f=1kHz	-14	-12	-10	dB
		f=2.5kHz	-14	-12	-10	dB
		f=6kHz	-14	-12	-10	dB
		f=15kHz	-14	-12	-10	dB
Total Harmonic Distortion	THD	f=1kHz, Vo=1.0V at all flat mode input	0.02	0.1		%
Output Noise Voltage	V _{NO}	All flat, input short, B.P.F., 10Hz to 30kHz	7	40		µV

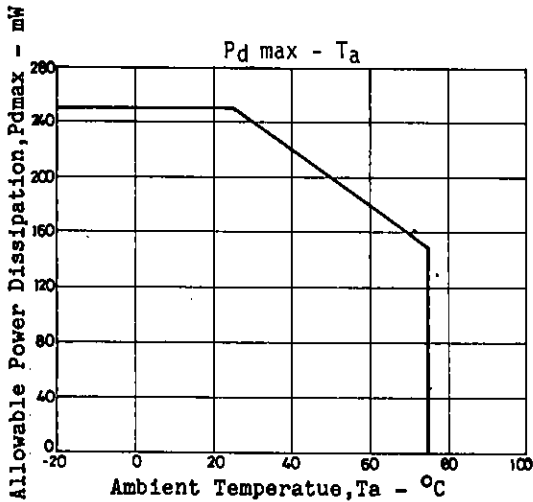

Test Method: V_{CC}=8V, R_L=10kohms, R_g=600ohms

Item	SW1	SW2	SW3	SW4	SW5	SW6	SW7	SW8	SW9	SW10	Conditions
I _{cco}	1	F	F	F	F	F	F	F	2	1	
V _G	2	F	F	F	F	F	F	F	1	1	f=1kHz V _{IN} =-10dB
B00ST1	2	B	F	F	F	F	F	F	1	1	f=60Hz
B00ST2	2	F	B	F	F	F	F	F	1	1	f=150Hz
B00ST3	2	F	F	B	F	F	F	F	1	1	f=400Hz
B00ST4	2	F	F	F	B	F	F	F	1	1	f=1kHz
B00ST5	2	F	F	F	F	B	F	F	1	1	f=2.5kHz
B00ST6	2	F	F	F	F	F	B	F	1	1	f=6kHz
B00ST7	2	F	F	F	F	F	F	B	1	1	f=15kHz
CUT1	2	C	F	F	F	F	F	F	1	1	f=60Hz
CUT2	2	F	C	F	F	F	F	F	1	1	f=150Hz
CUT3	2	F	F	C	F	F	F	F	1	1	f=400Hz
CUT4	2	F	F	F	C	F	F	F	1	1	f=1kHz
CUT5	2	F	F	F	F	C	F	F	1	1	f=2.5kHz
CUT6	2	F	F	F	F	F	C	F	1	1	f=6kHz
CUT7	2	F	F	F	F	F	F	C	1	1	f=15kHz
THD	2	F	F	F	F	F	F	F	1	1	f=1kHz, V _o =1.0V
V _{NO}	2	F	F	F	F	F	F	F	2	2	

LA3607

Sample Printed Circuit Pattern (Cu-foiled side)

Unit (resistance: Ω, capacitance: F)

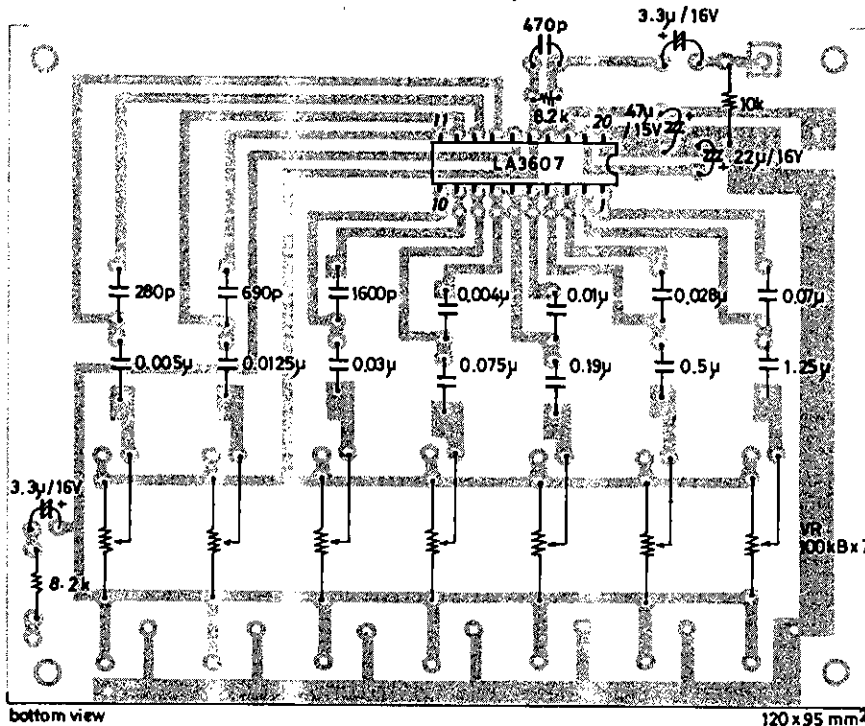

fo(resonance frequency)

In the sample application circuit, fo for each of 7 bands is set as follows:
fo=60Hz, 150Hz, 400Hz, 1kHz, 2.5kHz, 6kHz, 15kHz
fo is calculated using the following formula.

$$f_o = \frac{1}{2\pi \sqrt{C1 \cdot C2 \cdot R1 \cdot R2}}$$

Q (quality factor)

Q is calculated using the following formula.

$$q = \frac{\sqrt{C1 \cdot R2}}{C2 \cdot R1}$$

When Q is increased, the frequency band affected by the resonance circuit is narrowed and a clear distinction between this band and adjacent band is provided, but the frequency response swells greatly at all boost mode and the peak of the composite frequency is lowered. The above must be considered to fix C1, C2.

Description of external parts

- C1, C2 : Capacitors used to fix fo (resonance frequency)
- C3 : Input capacitor. Decreasing the capacitor value lowers the frequency response at low frequencies.
- C4 : Decoupling capacitor. Decreasing the capacitor value makes the effect of power supply stronger, whereby ripple is liable to occur.
- C5 : Power capacitor
- C6 : Output capacitor. Decreasing the capacitor value lowers the frequency response at low frequencies.

Proper cares in using IC

- . Maximum supply voltage V_{CC} max 20V must not be exceeded. The operating voltage is in the range of 5 to 15V.
- . Application of power with the pin-to-pin spaces shorted causes breakdown or deterioration of the IC to occur. When mounting the IC on the board or applying power, make sure that the pin-to-pin spaces are not shorted with solder, etc.

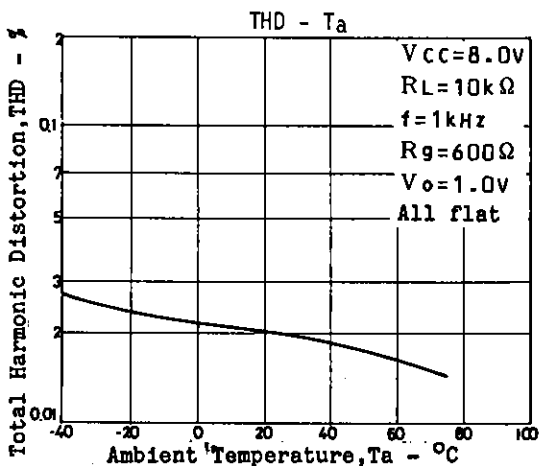
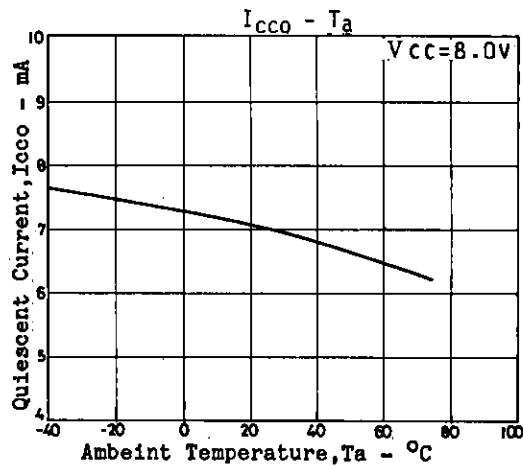
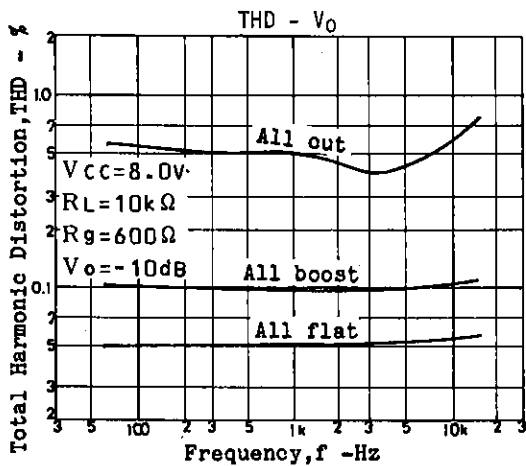
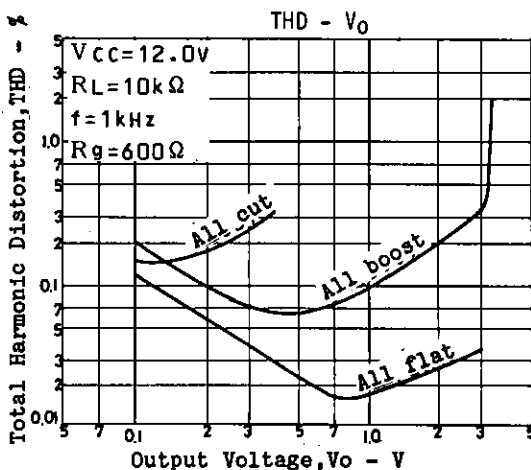
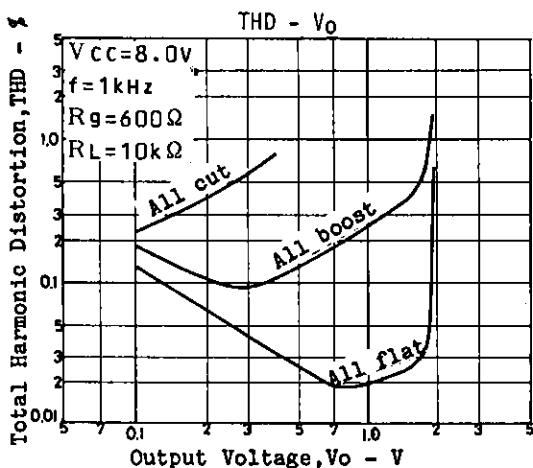
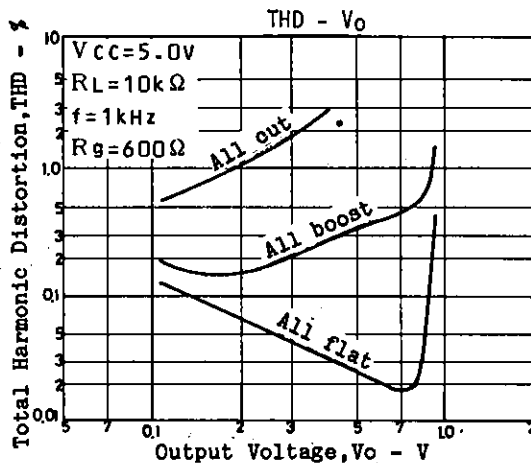
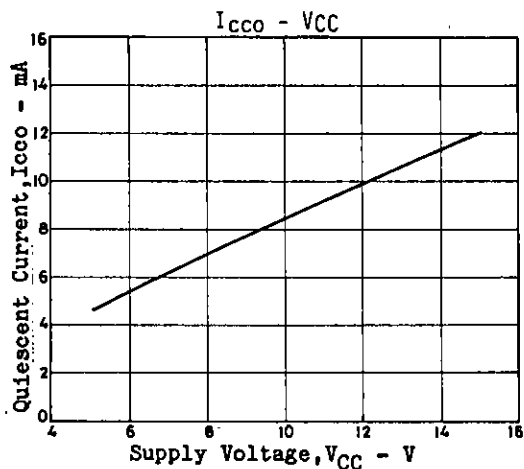

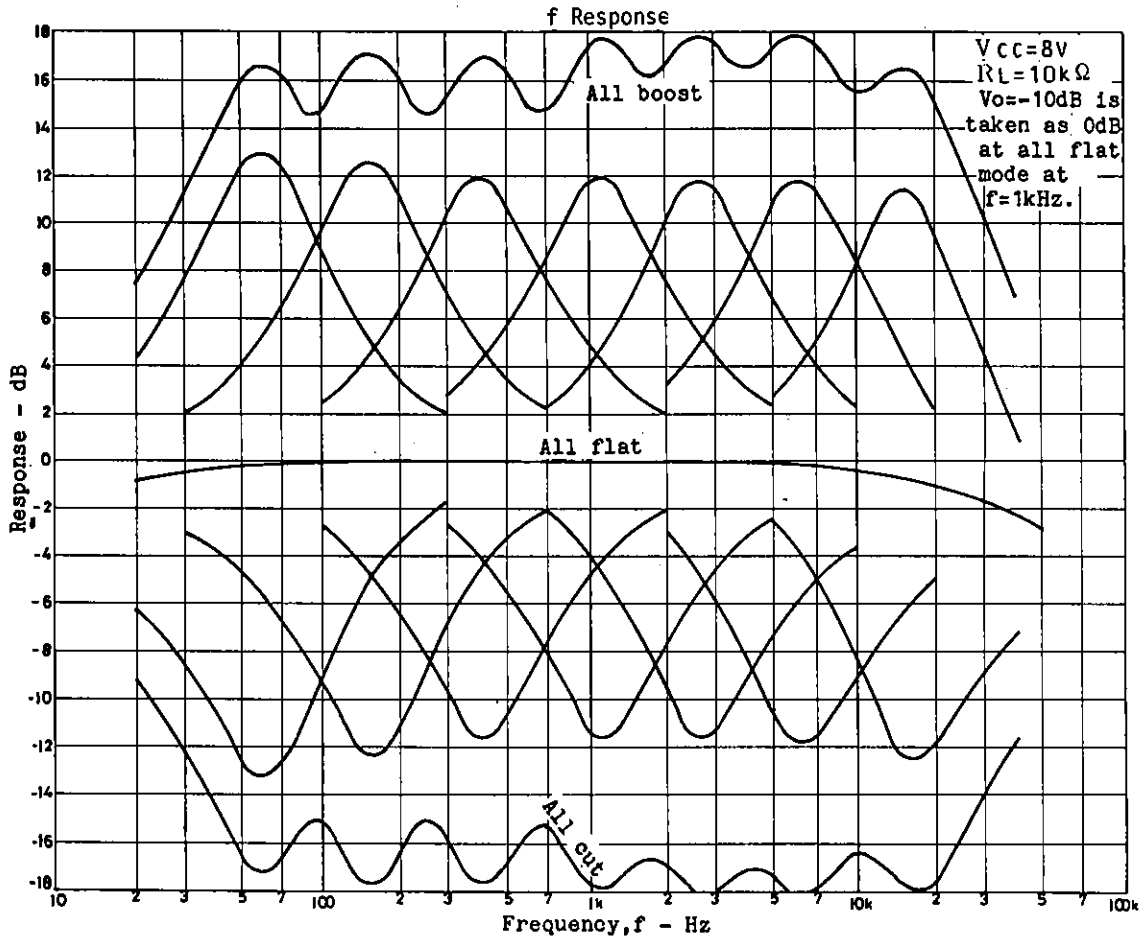

- No products described or contained herein are intended for use in surgical implants, life-support systems, aerospace equipment, nuclear power control systems, vehicles, disaster/crime-prevention equipment and the like, the failure of which may directly or indirectly cause injury, death or property loss.
- Anyone purchasing any products described or contained herein for an above-mentioned use shall:
 - ① Accept full responsibility and indemnify and defend SANYO ELECTRIC CO., LTD., its affiliates, subsidiaries and distributors and all their officers and employees, jointly and severally, against any and all claims and litigation and all damages, cost and expenses associated with such use;
 - ② Not impose any responsibility for any fault or negligence which may be cited in any such claim or litigation on SANYO ELECTRIC CO., LTD., its affiliates, subsidiaries and distributors or any of their officers and employees jointly or severally.
- Information (including circuit diagrams and circuit parameters) herein is for example only; it is not guaranteed for volume production. SANYO believes information herein is accurate and reliable, but no guarantees are made or implied regarding its use or any infringements of intellectual property rights or other rights of third parties.