

SANYO

No.1156B

LA6339M

High-Performance Quad Comparator

The LA6339M is a high-performance quad comparator that is capable of operating from a single power supply over a wide range of 2V to 36V. Because of its excellent input characteristics and low power, it can be very conveniently applied to multisignal parallel comparator circuits that require high-density assembly.

Features

- Wide supply voltage range (Single supply: 2.0 to 36.0V, dual supplies: ± 1.0 to ± 18.0 V)
- Wide common-mode input voltage range (0 to $V_{CC}-1.5$ V)
- Open collector output enabling wired OR
- Small current dissipation ($0.8\text{mA}/V_{CC}=5\text{V}$, $R_L=\infty$) and low power
- Mini flat package enabling compactness of sets

Maximum Ratings/ $T_a=25^\circ\text{C}$

			unit
Maximum power supply voltage	V_{CC} max	36	V
Differential input voltage	V_{ID}	36	V
Common-Mode input voltage range	V_{ICM}	-0.3~+36	V
Allowable power dissipation	P_d max	330	mW
Operating temperature	T_{opr}	-30~+85	$^\circ\text{C}$
Storage temperature	T_{stg}	-55~+125	$^\circ\text{C}$

Operating Characteristics/ $T_a=25^\circ\text{C}$, $V_{CC}=5\text{V}$

		Test circuit	Test			unit
			min	typ	max	
Input offset voltage	V_{IO}	1		± 2	± 5	mV
Input offset current	I_{IO}	2		± 5	± 50	nA
Input bias current	I_B	3		25	250	nA
Common-mode input voltage range	V_{ICM}		0	$V_{CC}-1.5$		V
Current dissipation	I_{CC}	4		0.8	2	mA
Voltage gain	V_G	5		200		V/mV
Response time		6		1.3		μs
Output sink current	I_{SINK}	7	6	16		mA
Output saturation voltage	V_{OL}	8		0.2	0.4	V
Output leak current	I_{LEAK}	9		0.1		nA

Equivalent Circuit

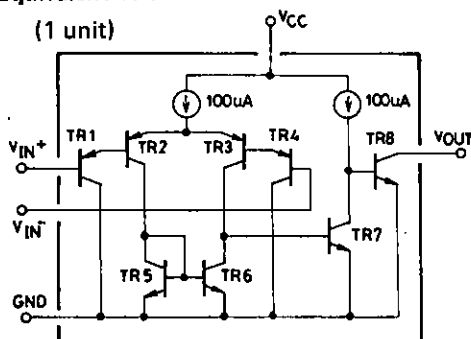

Pin Assignment

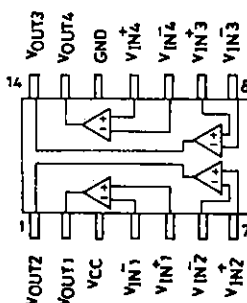

Package Dimensions 3034A-M14IC (unit: mm)

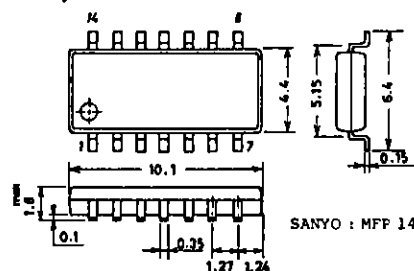

Test Circuits

1. Input offset voltage

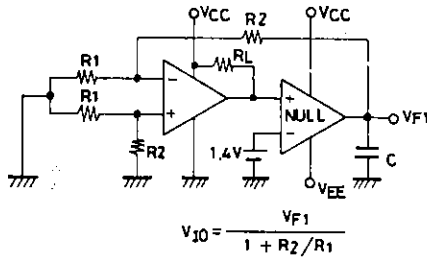

2. Input offset current

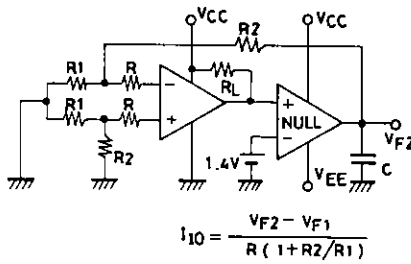

3. Input bias current

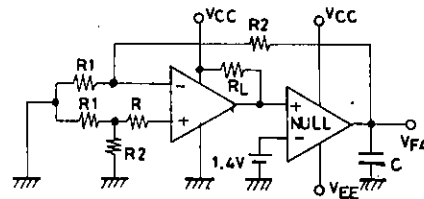
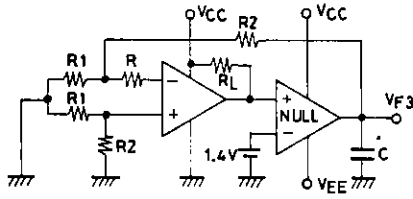

$$I_B = \frac{|VF3 - VF4|}{2R(1 + R2/R1)}$$

4. Current dissipation

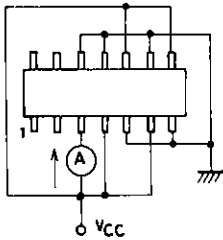

5. Voltage gain

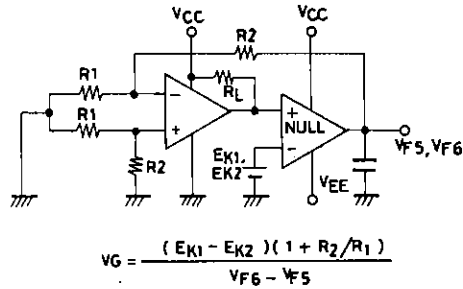

6. Response time

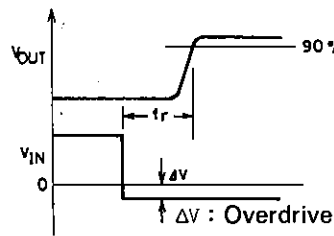
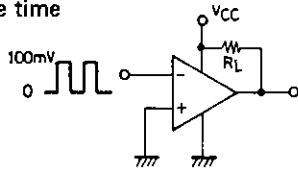

7. Output sink current

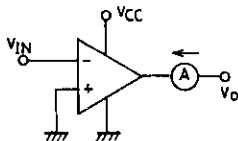

8. Output saturation voltage

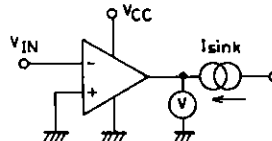

9. Output leak current

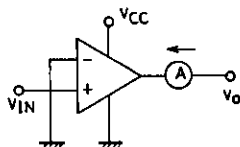

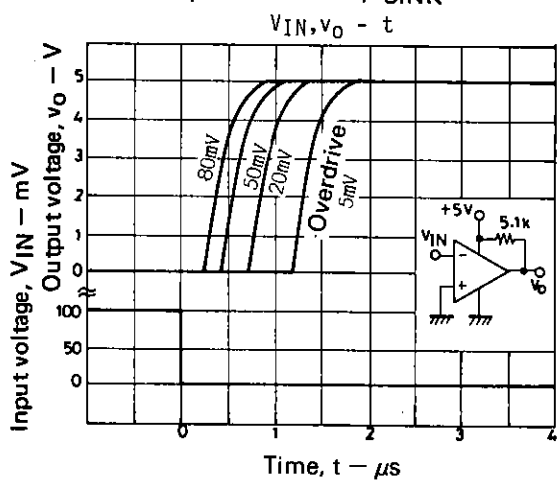
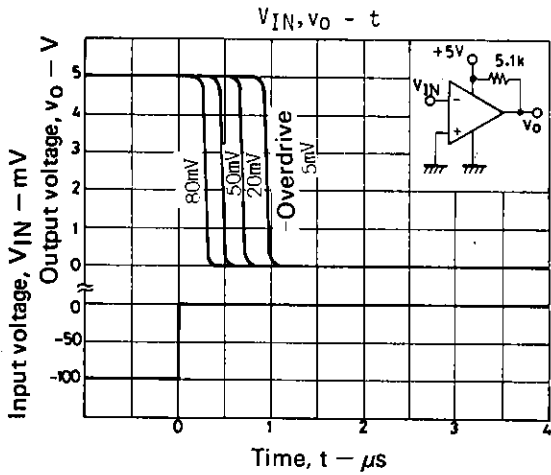
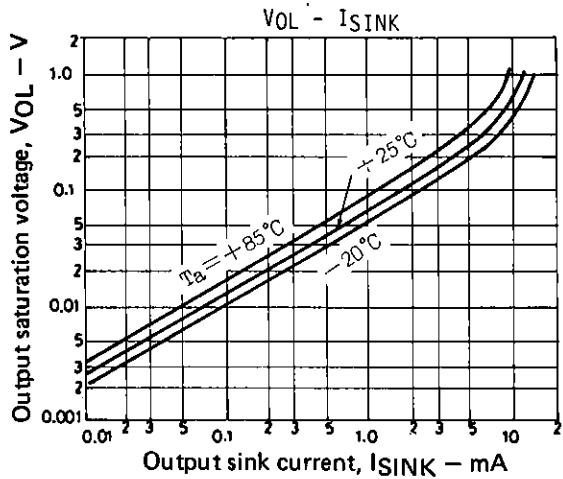
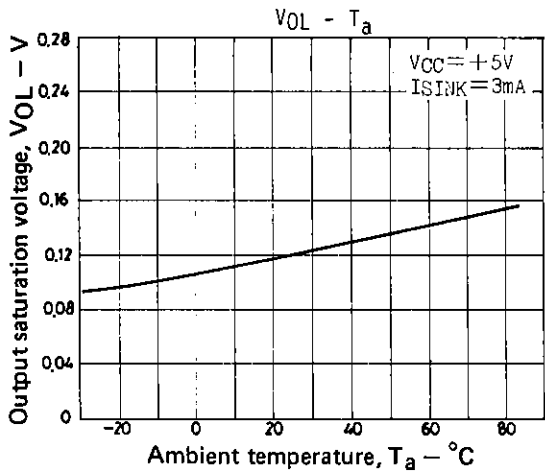
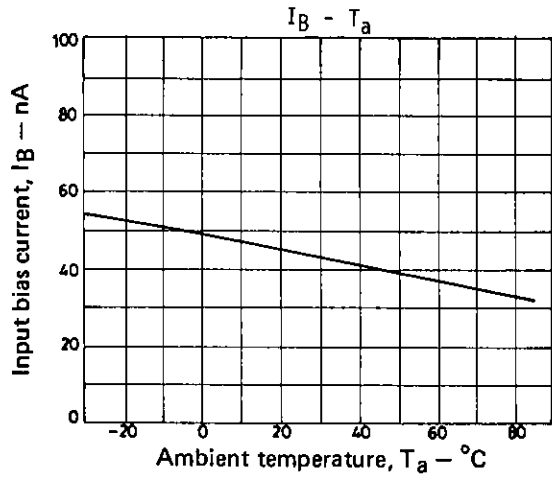
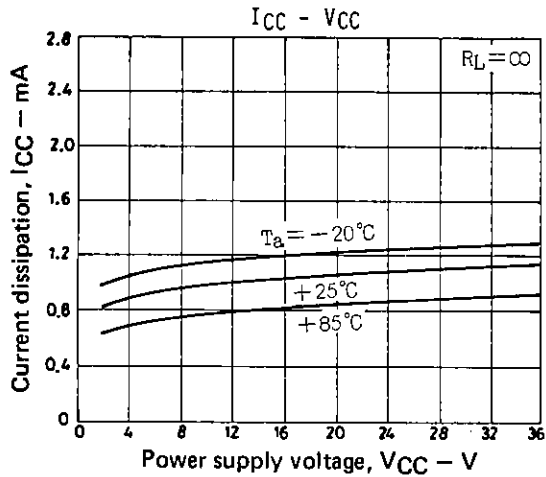

■ Sample Application Circuits

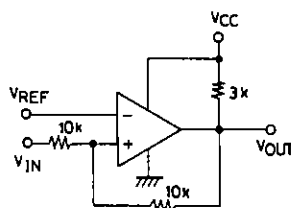

Voltage comparator
(with hysteresis)

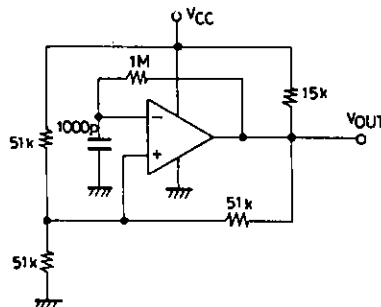

Square wave generator

Unit (resistance: Ω , capacitance: F)

- No products described or contained herein are intended for use in surgical implants, life-support systems, aerospace equipment, nuclear power control systems, vehicles, disaster/crime-prevention equipment and the like, the failure of which may directly or indirectly cause injury, death or property loss.
- Anyone purchasing any products described or contained herein for an above-mentioned use shall:
 - ① Accept full responsibility and indemnify and defend SANYO ELECTRIC CO., LTD., its affiliates, subsidiaries and distributors and all their officers and employees, jointly and severally, against any and all claims and litigation and all damages, cost and expenses associated with such use:
 - ② Not impose any responsibility for any fault or negligence which may be cited in any such claim or litigation on SANYO ELECTRIC CO., LTD., its affiliates, subsidiaries and distributors or any of their officers and employees jointly or severally.
- Information (including circuit diagrams and circuit parameters) herein is for example only; it is not guaranteed for volume production. SANYO believes information herein is accurate and reliable, but no guarantees are made or implied regarding its use or any infringements of intellectual property rights or other rights of third parties.