

SANYO

No. 4276

LA8517M**Audio Signal Processing Circuit for
Cordless Telephone Base Set Applications****Overview**

The LA8517M, an audio signal processing IC for cordless telephone answering machine applications, incorporates speech network, audio signal processing and cross-point switching functions into a single chip.

Applications**Speech Network**

- 2 to 4 wire conversion
- Impedance matching
- Line driver
- DTMF interfacing
- Transmitting amplifier
- Key tone interfacing
- Receiving amplifier

Audio Signal Processing

- Recorder preamplifier (with ALC)
- Playback equalizer amplifier
- Recorder amplifier
- Voice detection circuit (VOX)
- Power amplifier ($P_O = 200 \text{ mW}$, $R_L = 8\Omega$, $V_{CC} = 5 \text{ V}$)

Cross-point Switching

- 8 X 8 equivalent cross-point switching
- CPU interfacing (serial control)

Features**Speech Network**

- Supports direct interfacing using low impedance telephone receiver.
- Using dialer IC mute signaling, supports output to circuit following changeover of telephone receiver and dial signal (DTMF).
- Transmit gain and receive gain are controlled automatically in response to loop current.
- Supports forced attenuation of transmit gain and receive gain from gain control pin.
- Equipped with dial confirmation tone (key tone) input pin (mute signal control).
- Variety of handsets supported using externally connected components for varying transmit gain and receive gain.
- Outstanding for branch performance with low operating current.

Audio Signal Processing

- Supports single mechanism system.
- All necessary answering machine functions built-in; microcontroller control permits unique system construction.
- Built-in power amplifier.
- Permits independent settings for recording amplifier gain and recording bias current using external resistors.

Package Dimensions

unit : mm

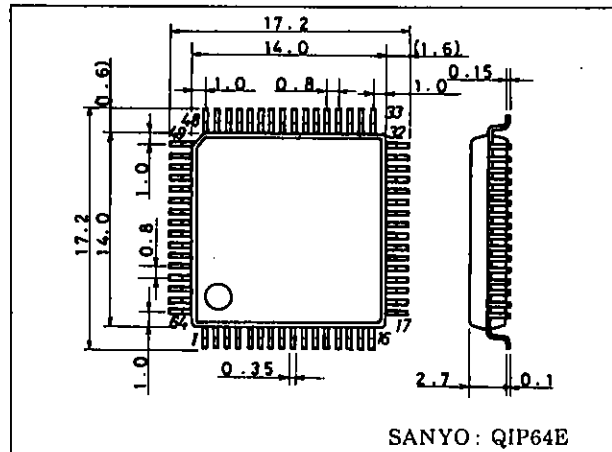
3159-QIP64E**SANYO Electric Co., Ltd. Semiconductor Business Headquarters**

TOKYO OFFICE Tokyo Bldg., 1-10, 1 Chome, Ueno, Taito-ku, TOKYO JAPAN

LA8517M

Continued from preceding page.

			min	typ	max	unit
<PB AMP>						
Voltage gain	V_{GE}	-60dBV input between pins 23 – 25	47	49	51	dB
Total harmonic distortion	THD	-60dBV input between pins 23 – 25		0.3	1.0	%
Equivalent input noise voltage	V_{NI}	23pin shorts (in terms of AC), 20Hz to 20kHz		1.0	5	μVrms
<OGM AMP>						
Voltage gain	V_{GC}	-20dBV input between pins 29 – 30	8	10	12	dB
Total harmonic distortion	THD	-20dBV input between pins 29 – 30		0.1	1.0	%
<REC AMP>						
Voltage gain	V_{GR}	Pin 21 $Z_{AC} = 9\text{k}\Omega$ between pins 27 – 22	-6	-4	-2	dB
Output bias voltage (pin 22 voltage)	V_B	Pin 21 $Z_{DC} = 15\text{k}\Omega$, 6.8 k Ω pin 22 load,	0.8	1.0	1.2	V
Total harmonic distortion	THD	-30 dBV input pin 9 , pin 22 fixed		0.5	1.0	%
<MIC AMP>						
Voltage gain	V_{GM}	-40dBV input between pins 34 – 36	28	30	32	dB
Total harmonic distortion	THD	-40dBV input between pins 34 – 36		0.1	1.0	%
Equivalent input noise voltage	V_{NI}	34 pin shorts (in terms of AC), 20Hz to 20kHz		1.5	5	μVrms
<POWER AMP : $R_L = 8\Omega$>						
Voltage gain	V_{GP}	-30dBV input between pins 45 – 42	28	30	32	dB
Output power	P_O	THD = 10%	200	250		mW
Total harmonic distortion	THD	-30dBV input between pins 45 – 42		0.5	1.5	%
Input resistance	R_i			60		k Ω
Ripple rejection	SVRR	$R_g = 0$, $f_r = 100\text{Hz}$, $V_r = -20\text{dBV}$	50	60		dB
Output noise voltage	V_{NO}	45 pin shorts (in terms of AC), 20Hz to 20kHz		0.04	0.1	mVrms
<VOX>						
Sensitivity 1	V_{OXL}	-24dBV input			0.3	V
Sensitivity 2	V_{OXH}	-28dBV input	4.5			V
<V_{REF}>						
Output voltage	V_{REF}		2.1	2.3	2.5	V
<CONTROL>						
Clock frequency	F_{CK}				500	kHz
Input signal "H" level	V_H		3			V
Input signal "L" level	V_L				1.5	V

Allowable power dissipation vs. ambient temperature

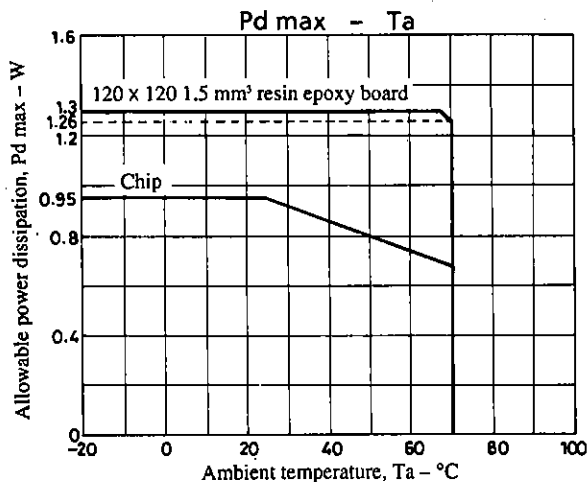

Specifications

Maximum Ratings at Ta = 25°C

				unit
Maximum supply voltage	V _L max	Speech network	15	V
	V _{CC} max	Excluding speech network	10	V
Loop current	I _L max		130	mA
Allowable power dissipation	P _d max		950	mW
Operating temperature	Topr		-20 to +70	°C
Storage temperature	Tstg		-40 to +150	°C

Operating Conditions at Ta = 25°C

				unit
Recommended supply voltage	V _{CC}	Excluding speech network	5	V
Supply voltage operating range	V _{CC} op	Excluding speech network	4.5 to 7.5	V

Operating Characteristics at Ta = 25°C, f = 1kHz

[Speech network]

			min	typ	max	unit
Line voltage	V _L	I _L = 20mA	3.3	3.8	4.3	V
		I _L = 50mA	5.5	6.3	7.1	V
		I _L = 120mA	10.2	12.2	14.2	V
Internal supply voltage	V _{CC}	I _L = 20mA	1.9	2.1	2.3	V
		I _L = 50mA	3.3	3.6	3.9	V
		I _L = 120mA	6.8	7.1	7.4	V
Transmitting gain	G _T	I _L = 20mA, V _{IN} = -55dBV	34	36	38	dB
		I _L = 120mA, V _{IN} = -55dBV	32	34	36	dB
Receiving gain	G _R	I _L = 20mA, V _{IN} = -20dBV	-5	-3	-1	dB
		I _L = 120mA, V _{IN} = -20dBV	-9.5	-7.5	-5.5	dB
DTMF gain	G _{MF}	I _L = 20mA, V _{IN} = -30dBV	19.5	21.5	23.5	dB
		I _L = 120mA, V _{IN} = -30dBV	17	19	21	dB
KTI gain	G _{KT}	I _L = 20mA, V _{IN} = -40dBV	12	14	16	dB
		I _L = 120mA, V _{IN} = -40dBV	14	16	18	dB
Transmitting dynamic range	DR _T	I _L = 20mA, THD = 4%	2.5			V _{P,P}
		I _L = 120mA, THD = 4%	4.5			V _{P,P}
Receiving dynamic range	DR _R	I _L = 20mA, THD = 10%	0.3			V _{P,P}
		I _L = 120mA, THD = 10%	0.5			V _{P,P}
DTMF input impedance	Z _{MF}		20		kΩ	
KTI input impedance	Z _{KT}		24		kΩ	
Mute input "H" level voltage	V _{IH}	I _L = 20mA to 120mA	V _{CC} /2		V _{CC}	V
Mute input "L" level voltage	V _{IL}	I _L = 20mA to 120mA	0		0.2	V
Transmitting PADC attenuation	Δ G _T	I _L = 30mA, 24kΩ ground		3		dB
Receiving PADC attenuation	Δ G _R	I _L = 30mA, 24kΩ ground		6		dB
Internal reference voltage	V _{REF}	I _L = 20mA		0.65		V
		I _L = 50mA		1.13		V
		I _L = 120mA		2.25		V

[Audio signal processing]

Quiescent current	I _{CCO}		10	21	30	mA
<PRE AMP>						
Voltage gain	V _{GC}	-48dBV input between pins 8 - 27	37	39	41	dB
Total harmonic distortion	THD	-30dBV input between pins 8 - 27		0.25	1.0	%
ALC saturation output level	V _{OS}	-30dBV input between pins 8 - 27	430	530	630	mVrms
ALC range	ALCW	After ALC is on and until THD becomes 1%	35	40		dB
Equivalent input noise voltage	V _{NI}	Number 8 pin shorts (in terms of AC), 20 Hz - 20 kHz		2.0	5	μVrms

Continued on next page.

Equivalent Circuit Block Diagram and Peripheral Circuits

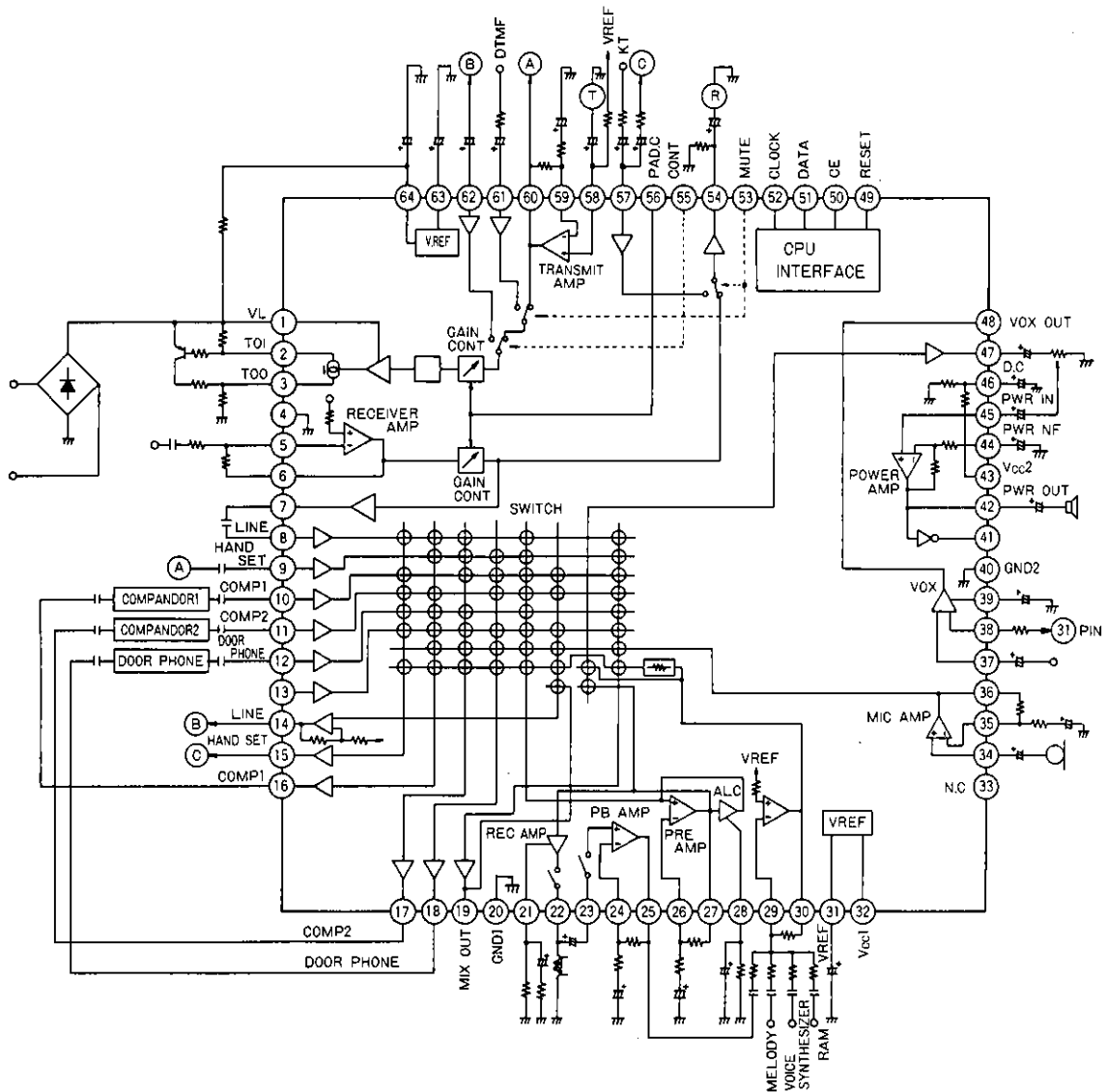

- | | | | |
|---------------|---------------|--------------|-------------|
| 1. VL | 17. COMP2 OUT | 33. NC | 49. RESET |
| 2. TOI | 18. DOOR OUT | 34. MIC IN | 50. CE |
| 3. TOO | 19. MIX OUT | 35. MIC NF | 51. DATA |
| 4. GND3 | 20. GND1 | 36. MIC OUT | 52. CLOCK |
| 5. RI IN | 21. BIAS/GAIN | 37. VOX IN | 53. MUTE |
| 6. RI OUT | 22. REC OUT | 38. VOX TH | 54. RD OUT |
| 7. RI MONI | 23. PB IN | 39. VOX C | 55. CONT |
| 8. LINE IN | 24. PB NF | 40. GND2 | 56. PAD C |
| 9. HAND IN | 25. PB OUT | 41. PWR OUT2 | 57. KT |
| 10. COMP1 IN | 26. PRE NF | 42. PWR OUT1 | 58. TI IN |
| 11. COMP2 IN | 27. PRE OUT | 43. Vcc2 | 59. TI NF |
| 12. DOOR IN | 28. ALC CT | 44. PWR NF | 60. TI OUT |
| 13. AUX IN1 | 29. OGM IN | 45. PWR IN | 61. DTMF |
| 14. LINE OUT | 30. OGM OUT | 46. D.C | 62. AUX IN2 |
| 15. HAND OUT | 31. VREF | 47. PWR MONI | 63. REF |
| 16. COMP1 OUT | 32. Vcc1 | 48. VOX OUT | 64. Vcc3 |

Test Circuit

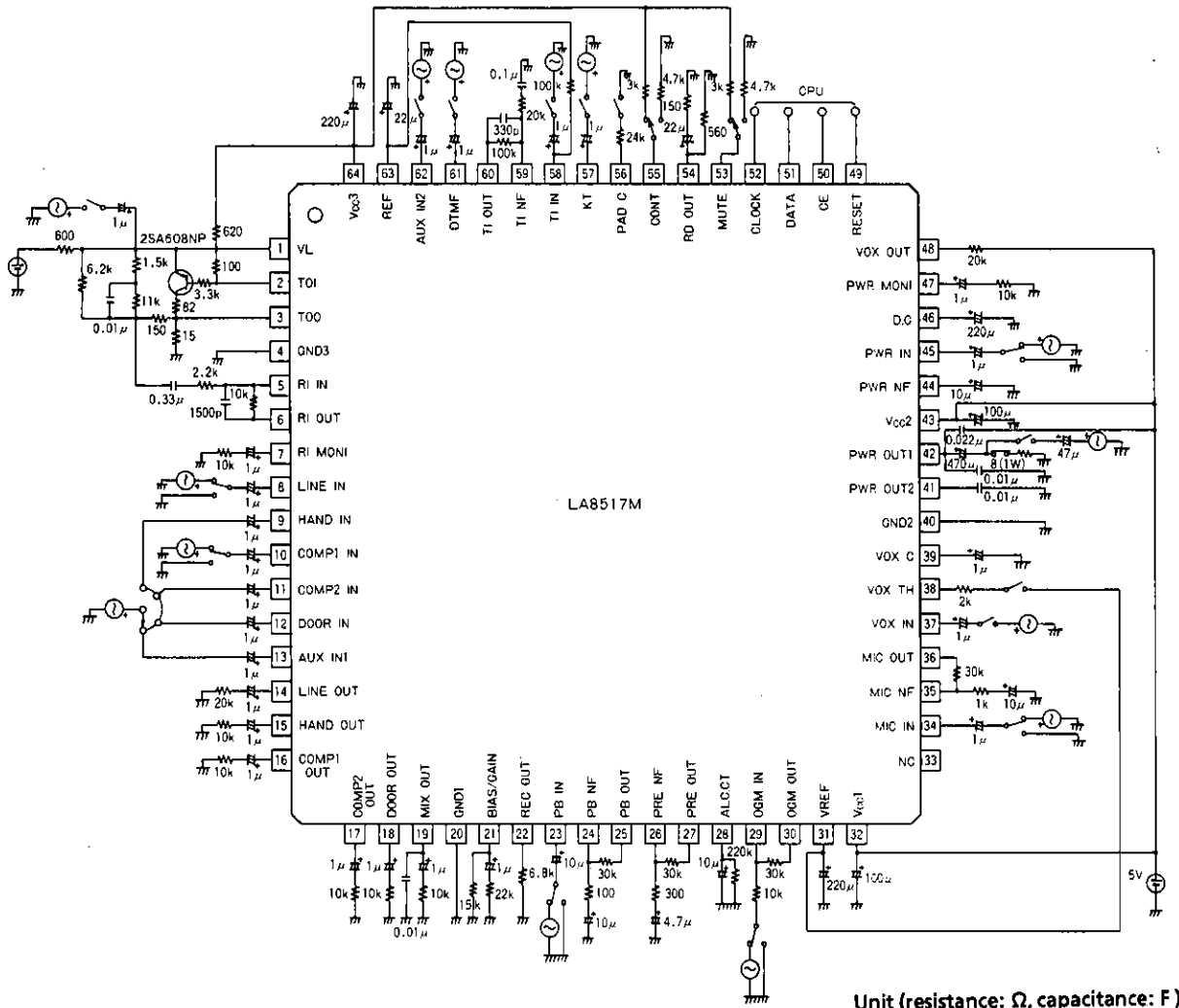

Unit (resistance: Ω, capacitance: F)

Description of Pin Functions

Unit (resistance: Ω)

Pin Number	Pin Name	Internal Equivalent Circuit	Pin Description
1	V _L		Input pin for Loop current and Line voltage.
2	TOI		Inlet pin for transmitting output current.
3	TOO		Transmitting output current output pin
4	GND3		Speech network system ground (GND) pin.
5	RI IN		Receiving input amplifier negative (-) input pin. Permits adjustments of gain and frequency performance using externally connected components.
6	RI OUT		Receiving input amplifier output pin.

Continued on next page.

LA8517M

Continued from preceding page.

Unit (resistance: Ω)

Pin Number	Pin Name	Internal Equivalent Circuit	Pin Description
7	RI MONI		Receiving input monitor amplifier output pin.
8	LINE IN		Line input pin.
9	HAND IN		Handset input pin.
10	COMP1 IN		Compandor 1 input pin.
11	COMP2 IN		Compandor 2 input pin.
12	DOOR IN		Door phone input pin.
13	AUX IN1		Auxiliary input pin.
14	LINE OUT		Line output pin.
15	HAND OUT		Handset output pin.
16	COMP1 OUT		Compandor 1 output pin.
17	COMP2 OUT		Compandor 2 output pin.
18	DOOR OUT		Door phone output pin.
19	MIX OUT		Mixing output pin.
20	GND1		Signal processing ground (GND) pin.
21	BIAS/GAIN		Bias pin. Supports control of recording amplifier gain and recording bias using external resistor.
22	REC OUT		Recording amplifier output pin.

Continued on next page.

LA8517M

Continued from preceding page.

Unit (resistance: Ω)

Pin Number	Pin Name	Internal Equivalent Circuit	Pin Description
23	PB IN		PB amplifier positive (+) input pin.
24	PB NF		PB amplifier negative (-) input pin.
26	PRE NF		Preamplifier negative (-) input pin.
34	MIC IN		Microphone amplifier positive (+) input pin.
35	MIC NF		Microphone amplifier negative (-) input pin.
25	PB OUT		PB amplifier output pin.
27	PRE OUT		Preamplifier output pin.
36	MIC OUT		Microphone amplifier output pin.
28	ALC. CT		ALC time constant connection pin.
29	OGM IN		Outgoing message (OGM) signal negative (-) input pin.
30	OGM OUT		Outgoing message (OGM) signal output pin.
31	V _{REF}		Internal reference voltage output pin.
32	V _{CC1}		Signal processing power supply pin.
33	N. C.		No connection (NC).

Continued on next page.

LA8517M

Continued from preceding page.

Unit (resistance: Ω)

Pin Number	Pin Name	Internal Equivalent Circuit	Pin Description
37	VOX IN		Voice detection (VOX) positive (+) input pin.
38	VOX TH		Voice detection (VOX) sensitivity adjustment pin. Adjusts VOX sensitivity using connection to V_{REF} (pin 31) with resistor located between.
39	VOX. C		Voice detection (VOX) output pin.
40	GND2		Power system ground (GND) pin.
41	PWR OUT2		Power amplifier 2 output pin (inverted).
42	PWR OUT1		Power amplifier 1 output pin (non-inverted).
44	PWR NF		Power amplifier negative (-) input pin.
45	PWR IN		Power amplifier positive (+) input pin.
46	D. C		Power amplifier reference voltage output pin (approximately $4/9 \times V_{CC2}$).
43	V_{CC2}		Power system power supply pin.
47	PWR MONI		Power amplifier output pin.
48	VOX		Voice detection (VOX) output pin, open-collector (O/C).
49	RESET		Reset pin. Resets with "L".
50	CE		Chip enable input pin.
51	DATA		Data input pin.
52	CLOCK		Clock Input pin.

Continued on next page.

Continued from preceding page.

Unit (resistance: Ω)

Pin Number	Pin Name	Internal Equivalent Circuit	Pin Description
53	MUTE		<p>Mute pin. Changes receiving signal, KT signal of receiving system and transmitting signal as well as DTMF signal of transmitting system.</p> <p>"H": Call settings "L": DTMF transmitting, KT receiving output</p>
55	CONT		<p>Control pin. When set to "L", signal input from AUX IN2 (pin 62) becomes transmitting output.</p>
54	RD OUT		<p>Receiving output pin. Connected to low impedance telephone receiver (approximately 150Ω) through capacitor.</p>
56	PADC		<p>PAD control pin. The value of the resistor between this pin and either the V_{CC3} (pin 64) or $GND3$ (pin 4) determines the shape of the Loop-current vs. gain control (auto PAD) characteristics.</p>
57	KT		<p>Key tone input. The input signal switches to receiving output when the MUTE pin (pin 53) is set to "L" for low.</p>
58	TI IN		<p>Transmitting input amplifier positive (+) input pin.</p>
59	TI NF		<p>Transmitting input amplifier negative (-) input pin.</p>
60	TI OUT		<p>Transmitting input amplifier output pin.</p>
61	DTMF		<p>DTMF input pin. The input signal becomes transmitting output when the MUTE pin (pin 53) is set to "L" for low.</p>

Continued on next page.

LA8517M

Continued from preceding page.

Unit (resistance: Ω)

Pin Number	Pin Name	Internal Equivalent Circuit	Pin Description
62	AUX IN2		Auxiliary input pin. The input signal switches to transmitting output when the CONT pin (pin 55) is set to "L" for low.
63	REF		Internal reference voltage output pin. Should not be used as an external power supply source.
64	Vcc3		Internal power supply pin. Internal circuit power supply voltage. Should not be used as an external power supply source other than for MUTE pin and CONT pin "H" (high) level voltage.

Sample Application Circuit

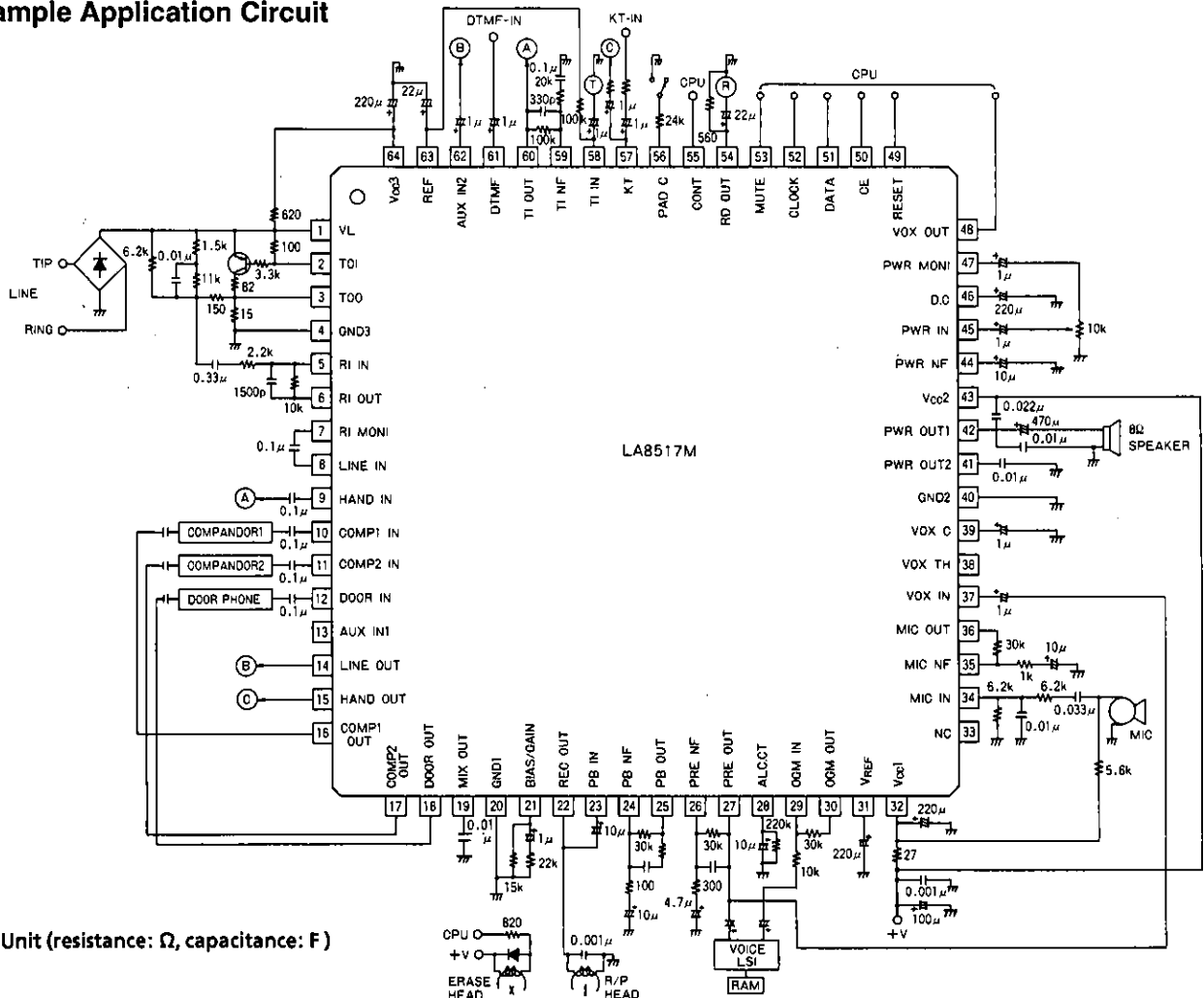

Functional Description

1) Speech Network

Unit (resistance: Ω , capacitance: F)

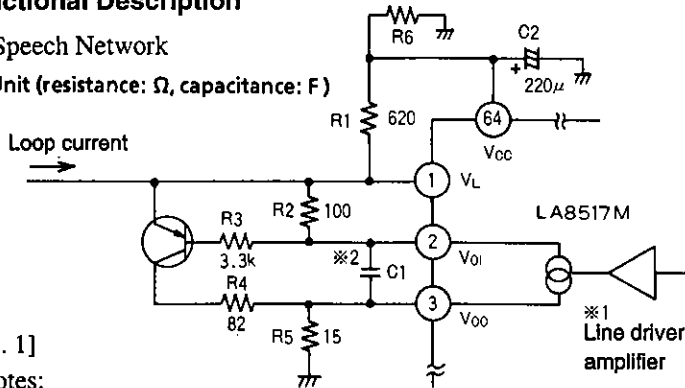

[Fig. 1]

Notes:

- *1. The line driver amplifier absorbs transmitting signal delivery and direct current.
- *2. In cases of oscillation caused by load conditions existing between V_L and GND, a 0.1 μ F rated capacitor should be installed.

Since the LA8517 is equipped with a built-in power amplifier, a surface mount transistor for the allowable demand should be attached as shown in figure 1 so that loop current is consumed outside the IC. Loop current flowing to the transistor can be controlled by varying the R3 base resistor. R4 and R5 allowable electrical power setting reflects the maximum current requirements of the expected loop current.

• **Modifying Direct Current Resistance**

Unit (resistance: Ω , capacitance: F)

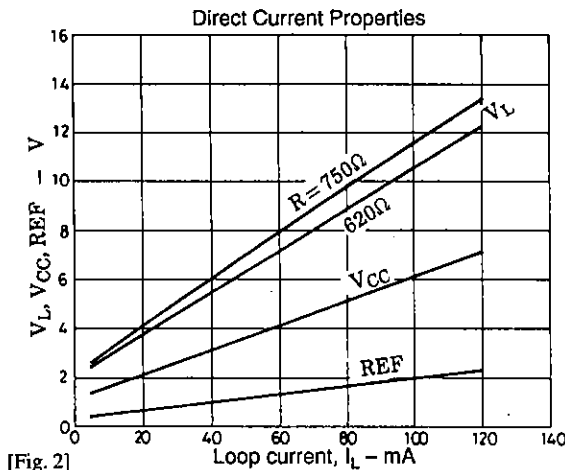

[Fig. 2]

- ① By varying R1 (620 Ω), direct current resistance can be modified as shown in figure 2. Under such circumstances, the alternating current impedance is also changed.

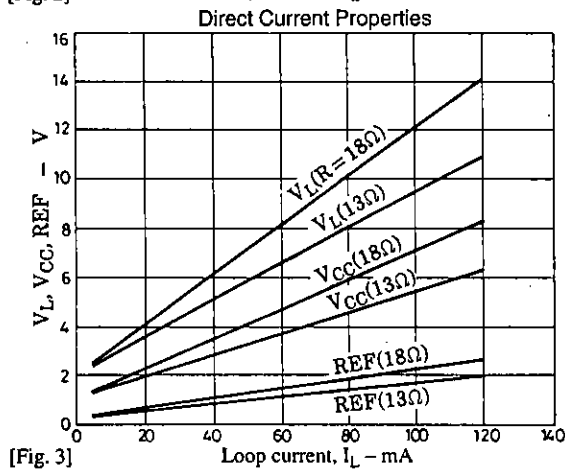
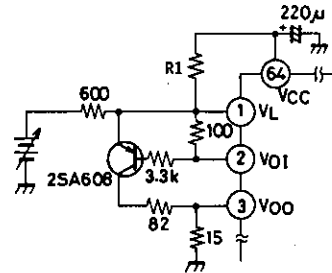

[Fig. 3]

- ② By varying R5 (15 Ω), direct current resistance can be modified as shown in figure 3. Under such circumstances, BN (balancing network) conditions and transmitting gain are also changed.

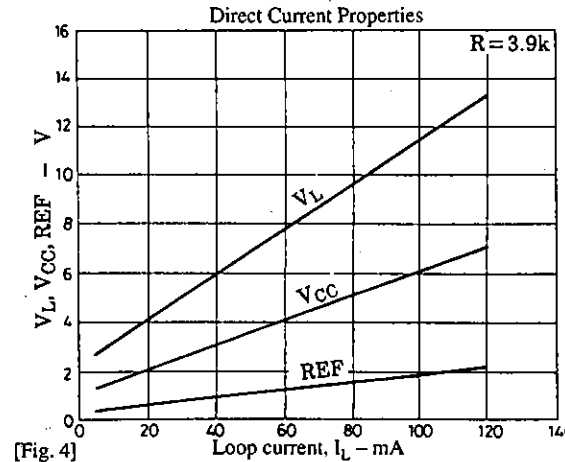
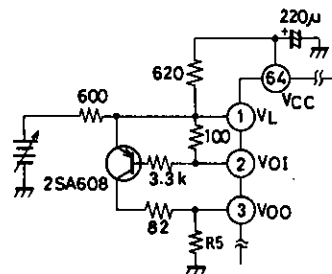

[Fig. 4]

- ③ Direct current resistance can also be altered, as shown in figure 4, by establishing a connection from the V_{CC} pin (pin 64) through an R6 to the ground (GND).

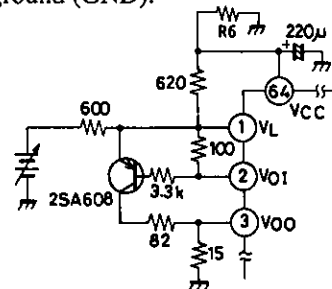

• Setting Alternating Current Impedance

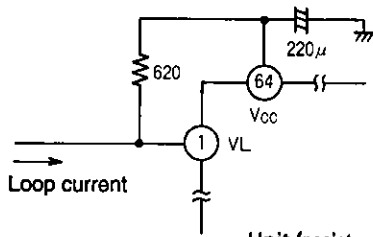

Alternating current impedance is fundamentally decided according to 620Ω $220\mu\text{F}$. In practice, because current loads, other than those of the speech network, enter from the line, alternating current impedance is synthetically adjusted to match the impedance of the speech network.

Unit (resistance: Ω , capacitance: F)

Gain Allocation

① Transmitting Gain Allocation

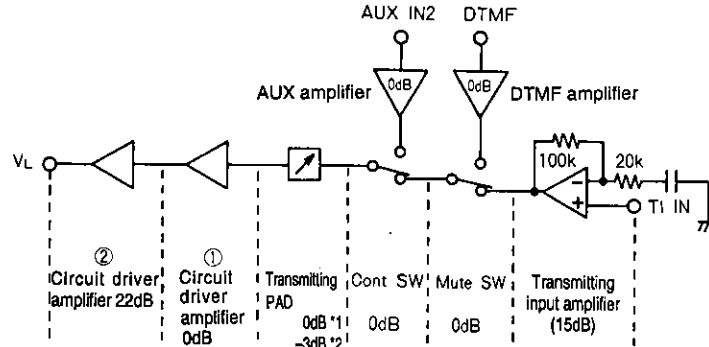

*1, $I_L = 20\text{mA}$. *2, $I_L = 120\text{mA}$.
*Loop 600Ω at termination

Unit (resistance: Ω)

② Receiving Gain Allocation

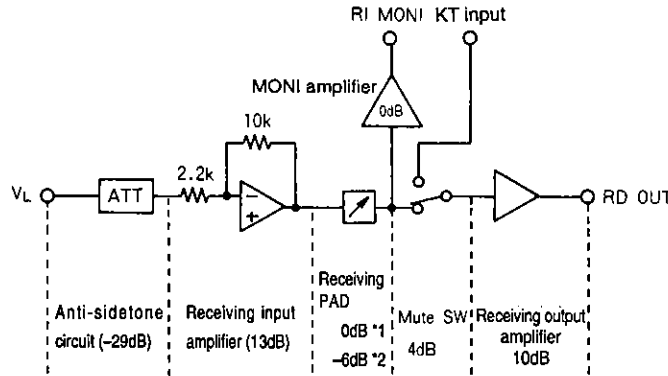

* MONI amplifier gain differs depending on the load (approximately -2 dB at $R_L = 10\text{k}\Omega$).
* Gain numeric values are summary values.
* Values represented within parenthesis may be modified using externally attached components.

Unit (resistance: Ω)

• Gain Control Circuit (PADC pin)

① PADC pin open (auto PAD)

Loop current capacity which supports transmitting and receiving gain is automatically adjusted. When transmitting is approximately -3dB and when receiving is approximately -6dB , attenuation follows the increase of loop current.

② PADC pin connected to ground (GND) using resistor

Gain attenuation begins using a loop current capacity which is lesser than when the PADC pin is open.

③ PADC pin connected to V_{CC} using resistor

Gain attenuation begins using a loop current capacity which is greater than when the PADC pin is open.

• Receiving Amplifier

Uses a dynamic receiver.

2) Signal Processing

• ALC

ALC operates with input ranging between approximately -45dBV to -5dBV . ALC saturation power level is approximately 500 mVrms .

• V/I Conversion

V/I conversion is made to draw the recording current for DC bias. The conversion gain and bias current can be controlled using an external resistor connected to pin 21. DC equalling pin 21 DC output is output from pin 22.

• VOX

Detects the presence or absence of a call. When the VOX input pin (pin 37) signal is -24dB or greater, the VOX output pin (pin 47) switches to "L" for low. Detection level adjustments may be performed by installing an R resistor between VOX TH (pin 38) and V_{REF} (pin 31) as shown in the following figure.

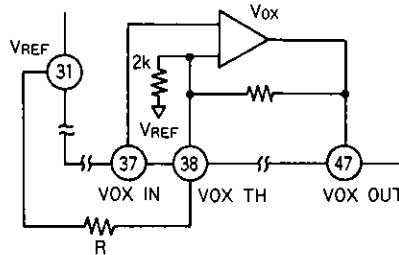

Unit (resistance: Ω)

3) Power Amplifier

• Oscillation prevention Capacitor

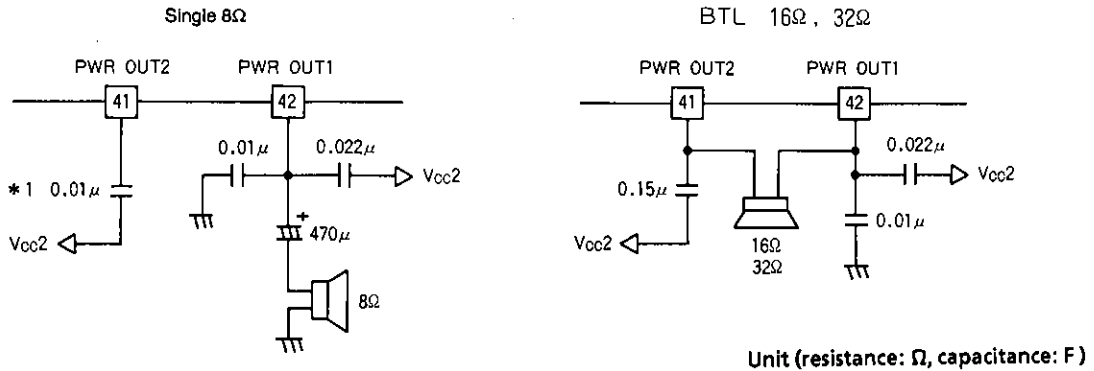

Unit (resistance: Ω , capacitance: F)

Note: A Mylar capacitor is recommended as a damping capacitor. (A ceramic capacitor may be use in * 1.)

• Mute

Under mute conditions, power amplifier output impedance switches to high impedance.

4) Cross-point

• Mixing

Mixing is possible with MIX OUT only (pin 19).

• Line Output Amplifier

Line output amplifier gain becomes approximately 16dB . When set to -6dB using serial control, line output amplifier gain is established at approximately 10dB .

Serial Control Input Data Format

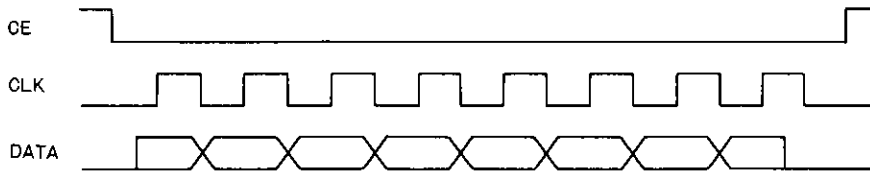

Serial Data Contents

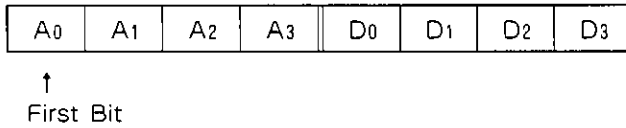

- A₃ = 0 ⇒ Displays control data for cross-point switching. At such a time, A₂ through A₀ indicate cross-point switching output addresses.
 - A₃ = 1, A₂ = 0 ⇒ Indicates mixing output control data.
 - A₃ = 1, A₂ = 1 ⇒ Indicates audio signal processing control data.
- Table 1 indicates contents.

A ₃	A ₂	A ₁	A ₀	Contents	
0	0	0	0	Output address 0	HANDSET
0	0	0	1	Output address 1	COMP 1
0	0	1	0	Output address 2	COMP 2
0	0	1	1	Output address 3	DOOR PHONE
0	1	0	0	Output address 4	PRE AMP
0	1	0	1	Output address 5	LINE
0	1	1	0	Output address 6	POWER
1	0	0	0	Output address 7A	MIXING OUT
1	0	0	1	Output address 7B	MIXING OUT
1	1	*	*	CONTROL DATA	

* : don't care

[Table 1]

D₃toD₀: Input addresses for cross-point switching control data are shown in table 2. Table 3 shows address assignments for mixing output control data. On/off settings for all controls are indicated in table 4 for audio signal processing control data.

D ₃	D ₂	D ₁	D ₀	Contents	
0	0	0	0	ALL OFF	
0	0	0	1	Input address 1	LINE
0	0	1	0	Input address 2	HANDSET
0	0	1	1	Input address 3	COMP 1
0	1	0	0	Input address 4	COMP 2
0	1	0	1	Input address 5	DOOR PHONE
0	1	1	0	Input address 6	AUX
0	1	1	1	Input address 7	MIC
1	0	0	0	Input address 8	OGM
*	0	0	1	Input address 9	PRE (Used only with output address 6)
*	0	1	0	Input address 10	MIX (Used only with output address 5)

* : don't care

[Table 2]

Item	Contents	
	Output Address 7-A	Output Address 7-B
D ₀	Input address 1 LINE	Input address 5 DOOR PHONE
D ₁	Input address 2 HANDSET	Input address 6 AUX
D ₂	Input address 3 COMP 1	Input address 7 MIC
D ₃	Input address 4 COMP 2	Input address 8 OGM

[Table 3]

Item	Contents		
	A ₁	LINE -6dB	1: On
D ₀	ALC	1: On	0: Off
D ₁	PB	1: On	0: Off
D ₂	REC	1: On	0: Off
D ₃	POWER AMP MUTE	1: Mute	0: Release

[Table 4]

Input Address Port Timing

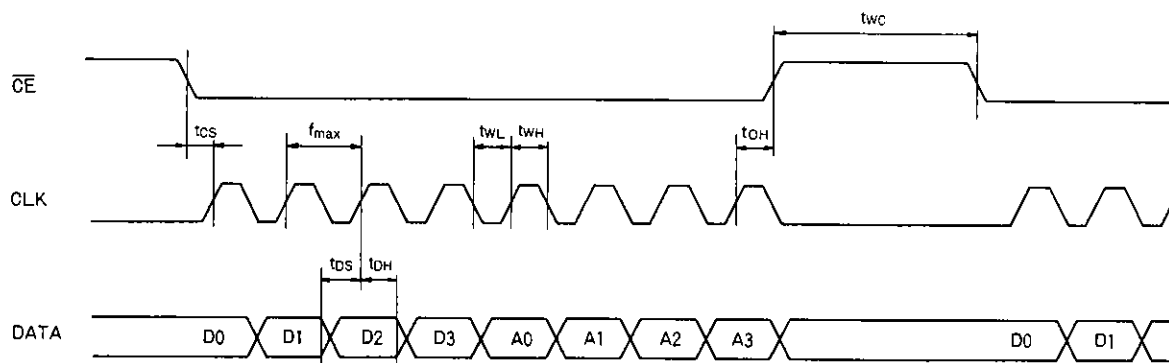

- f_{max} (Maximum clock frequency) 500kHz
- t_{WL} (Clock pulse width "L") 250ns or more
- t_{WH} (Clock pulse width "H") 250ns or more
- t_{CS} (Chip enable setup time) 200ns or more
- t_{CH} (Chip enable hold time) 400ns or more
- t_{DS} (Data setup time) 250ns or more
- t_{DH} (Data hold time) 250ns or more
- t_{WC} (Chip enable pulse width) 400ns or more

Proper Care for IC Applications

- 1) PCB
During PCB manufacturing, the ground (GND) line of pin 20 becomes thicker and shorter. When common impedance is applied, problems may occur due to distorted coefficients.
- 2) If the IC is used in the vicinity of the maximum rating, even a slight variation in conditions may cause the maximum rating to be exceeded, thereby leading to a breakdown. Allow an ample margin of variation in such areas as supply voltage and use the IC in a range where the maximum rating will not be exceeded.
- 3) Shorting Between Pins
If the power supply is applied when the space between pins is shorted, a breakdown or deterioration may occur. When installing the IC on the board or applying the supply voltage, make sure that the space between pins is not shorted with solder or by other means.
- 4) Load Shorting
If the IC is used with the load shorted for a long time, a breakdown or deterioration may occur. Be sure not to short the load.

Serial Control Mode

The following table indicate basic modes.

Mode	Serial Data								Notes
	A ₀	A ₁	A ₂	A ₃	D ₀	D ₁	D ₂	D ₃	
ICM REC	0	0	1	0	1	0	0	0	Input is set to LINE while output sets to PRE.
	0	1	1	0	1	0	0	*	Input is set to PRE while output sets to PWR.
	*	*	1	1	1	0	1	0	ALC and REC are on.
2 WAY REC	0	0	1	0	1	0	0	0	Input is set to LINE while output sets to PRE.
	*	*	1	1	1	0	1	0	ALC and REC are on.
DECT REC	0	0	1	0	1	1	1	0	Input is set to MIC while output sets to PRE.
	*	*	1	1	1	0	1	0	ALC and REC are on.
2 WAY BEEP	0	1	1	0	0	0	0	1	Input is set to OGM while output sets to PWR.
	0	0	1	0	0	0	0	1	Input is set to OGM while output sets to PRE.
	1	0	1	0	0	0	0	1	Input is set to OGM while output sets to LINE.
	*	*	1	1	1	0	1	0	ALC and REC are on.
ICM OUT	0	1	1	0	0	0	0	1	Input is set to OGM while output sets to PWR.
	1	0	1	0	0	0	0	1	Input is set to OGM while output sets to LINE.
	*	*	1	1	0	1	0	0	PB ON
ICM PLAY	0	1	1	0	0	0	0	1	Input is set to OGM while output sets to PWR.
	*	*	1	1	0	1	0	0	PB ON
OGM REC	0	0	1	0	1	1	1	0	Input is sets to MIC while output sets to PRE.
	*	*	1	1	1	0	0	0	ALC ON
OGM CHANGE	0	0	1	0	1	0	0	0	Input is set to LINE while output sets to PRE.
	0	1	1	0	1	0	0	*	Input is set to PRE while output sets to PWR.
	*	*	1	1	1	0	0	0	ALC ON
OGM OUT	0	1	1	0	0	0	0	1	Input is set to OGM while output sets to PWR.
	1	0	1	0	0	0	0	1	Input is set to OGM while output sets to LINE.
OGM PLAY	0	1	1	0	0	0	0	1	Input is set to OGM while output sets to PWR.
ROOM MONI	1	0	1	0	1	1	1	0	Input is set to MIC while output sets to LINE.
ROOM OUT	0	0	1	0	1	0	0	0	Input is set to LINE while output sets to PRE.
	0	1	1	0	1	0	0	*	Input is set to PRE while output sets to PWR.
VOICE SELE	1	0	1	0	0	0	0	1	Input is set to OGM while output sets to LINE.
	0	0	1	0	1	0	0	0	Input is set to LINE while output sets to PRE.
	0	1	1	0	1	0	0	*	Input is set to PRE while output sets to PWR.
Dialogue REC	1	0	1	0	0	0	0	1	Input is set to OGM while output sets to LINE.
	0	0	1	0	1	0	0	0	Input is set to LINE while output sets to PRE.
	*	*	1	1	1	0	1	0	ALC and REC are on
Extension calling (main phone ← → extension phone)	1	0	0	0	0	1	0	0	Input is set to HAND while output sets to COMP1.
	0	0	0	0	1	1	0	0	Input is set to COMP1 while output sets to HAND.
Extension phone → external line (used for accessing an external line)	1	0	1	0	1	1	0	0	Input is set to COMP1 while output sets to LINE.
	1	0	0	0	1	0	0	0	Input is set to LINE while output set to COMP1.

"1" = High, "0" = Low

* : don't care

Mode Description

- 1) ICM REC (Incoming Message Rec.)
 - Incoming message recording.
 - Recording of dictation from distant location (remote-controlled at separate location).
- 2) 2-way REC
 - Recording of both conversations while talking over the telephone.
 - Incoming message recording.
- 3) DICT REC
 - Dictation recording using microphone (records family messages or other messages with limited contents).
- 4) 2-way BEEP
 - Outputs alarm sound to speaker and if recording incoming message (ICM), simultaneously activates line output to also inform caller.
 - Informs caller of recording activity.
 - Line output sets to 6dB for line output of other modes.
- 5) ICM OUT
 - Incoming message playback.
 - Listening to the incoming message using telephone from distant location.
 - Incoming message transfer.
 - Recorded dictation playback.
- 6) ICM PLAY
 - Incoming message playback.
 - Recorded dictation playback.
- 7) OGM REC (Outgoing Message Rec.)
 - Outgoing message recording.
- 8) OGM CHANGE
 - Changing outgoing message from distant location using remote control operations.
- 9) OGM OUT
 - Outgoing message playback.
 - Outgoing message transmitting (with remote control operations, etc.).
- 10) OGM PLAY
 - Outgoing message playback and confirmation.
- 11) ROOM MONI
 - Listening to microphone input using remote control operations from distant location.
- 12) ROOM OUT
 - Generating speaker output such as messages using remote control operations from distant location.
- 13) VOICE SELE
 - Confirming speaker output of other person's voice along with outgoing message transmission.
- 14) Dialog REC
 - Recording incoming message while transmitting outgoing message.

Direct Current Properties

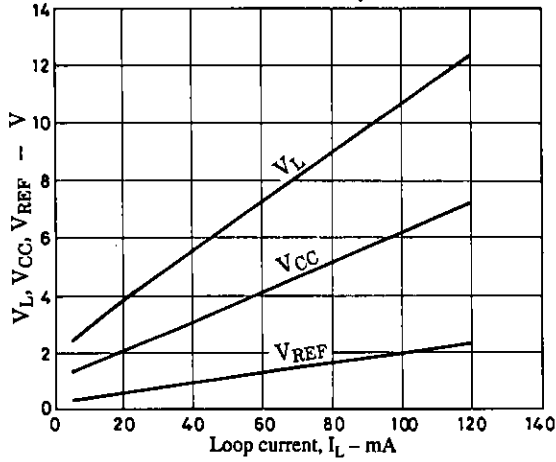

Unit (resistance: Ω , capacitance: F)

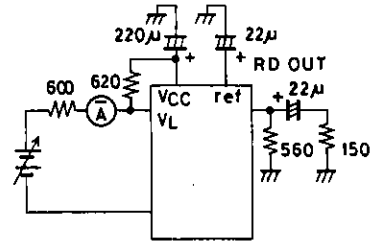

Transmitting Gain - I_L

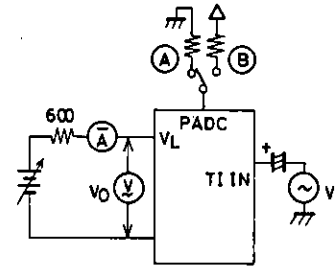
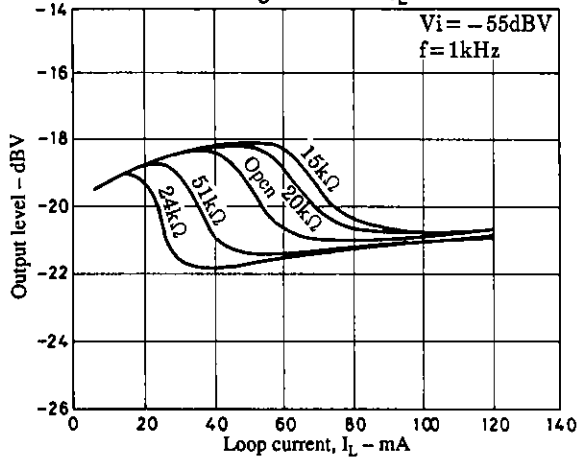

Receiving Gain - I_L

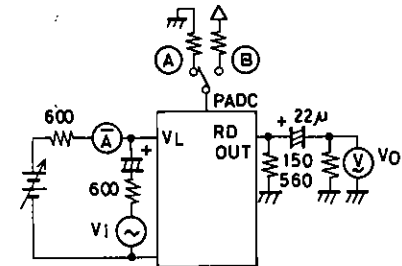
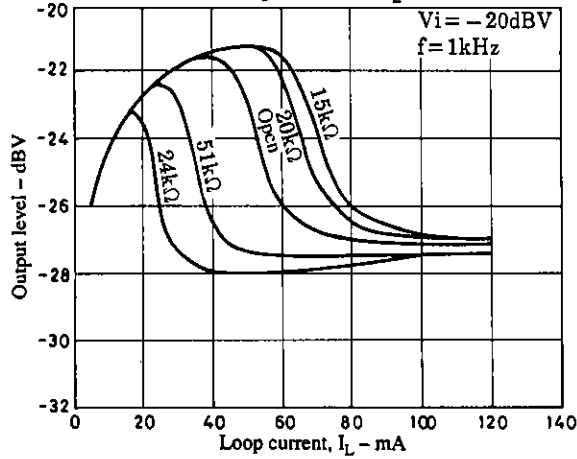

Dynamic Range - I_L

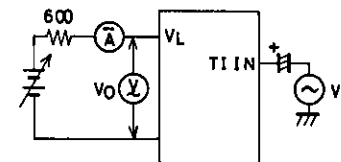
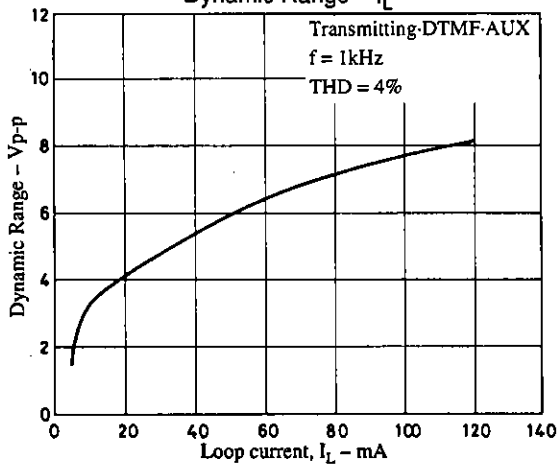

Dynamic Range - I_L

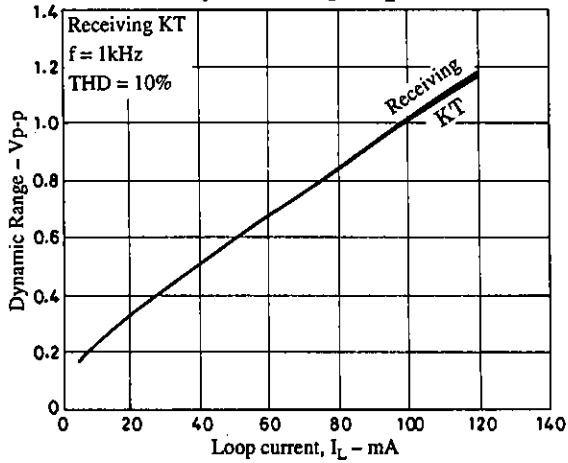

Unit (resistance: Ω , capacitance: F)

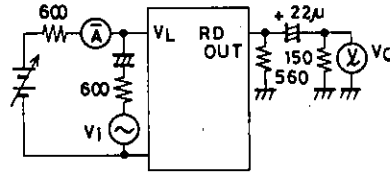

$I_{CCO} - V_{CC}$

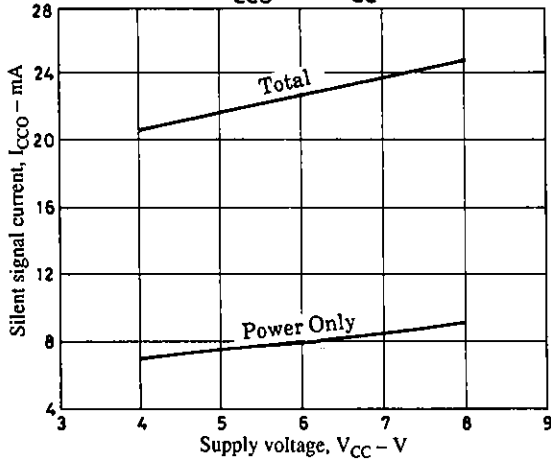

$V_{REF} - V_{CC}$

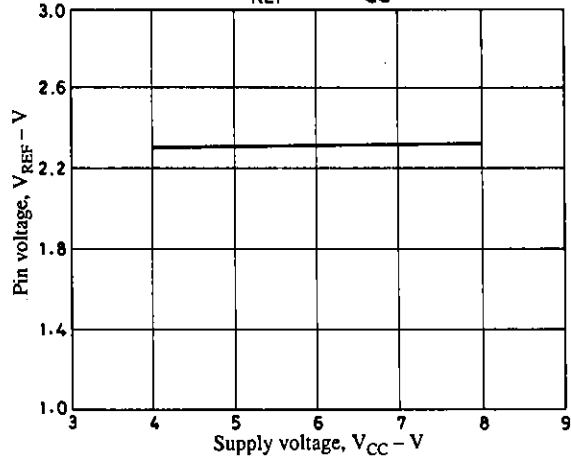

$V_{IN} - V_{CC}$

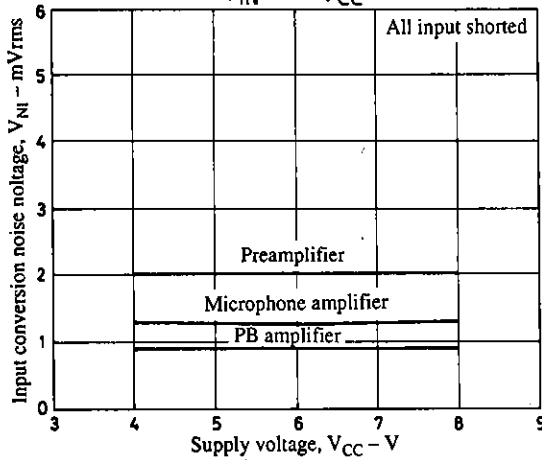

ALC Characteristics

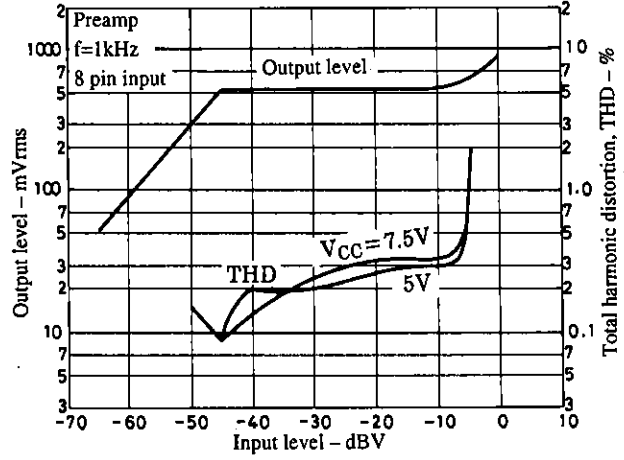

$V_{G, THD} - f$

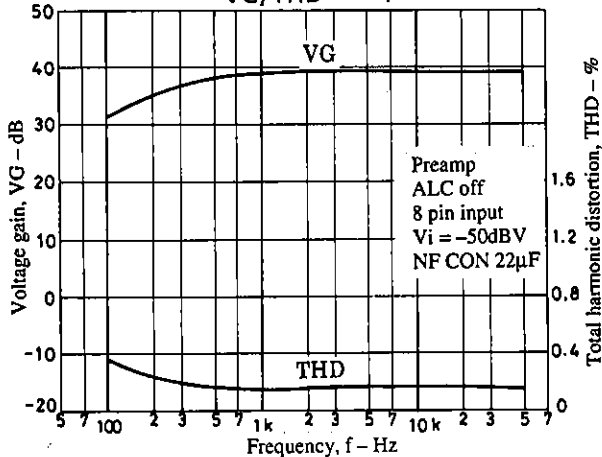

$V_{G, THD} - f$

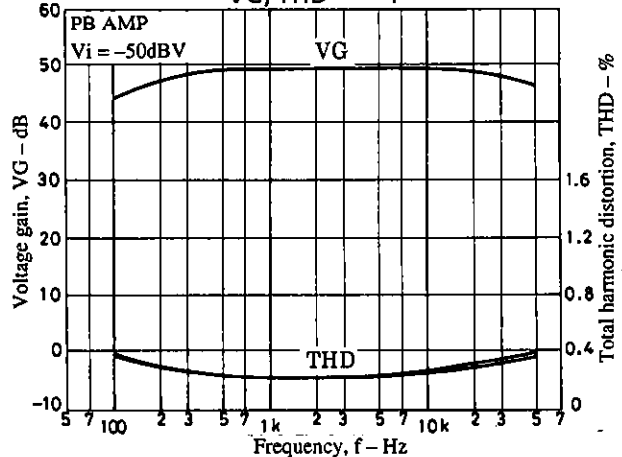

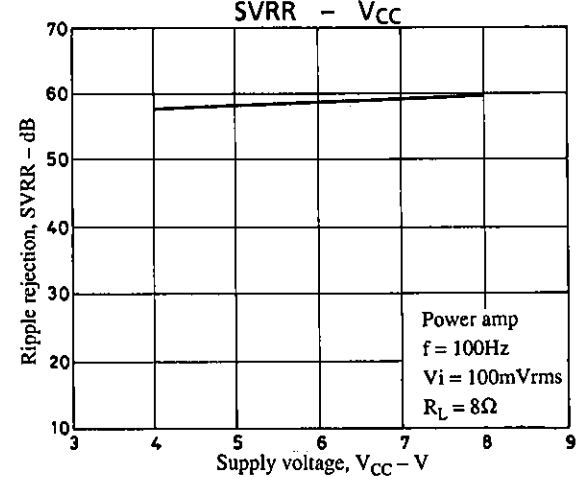
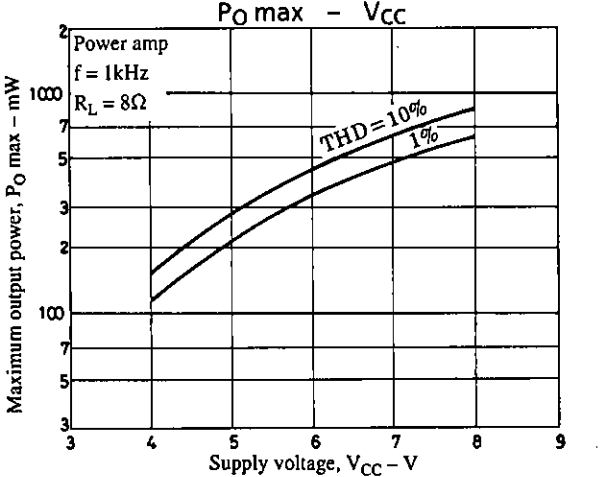
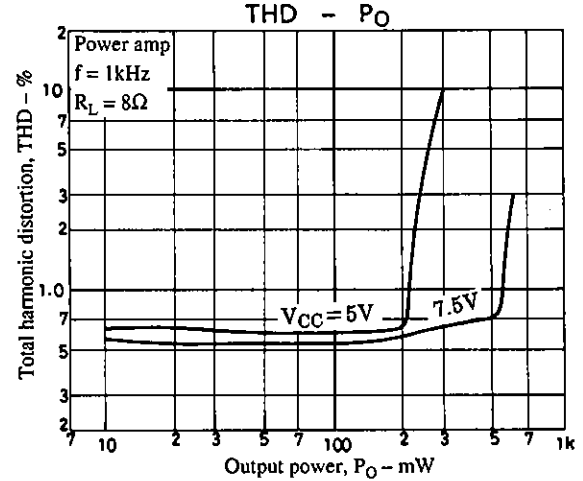
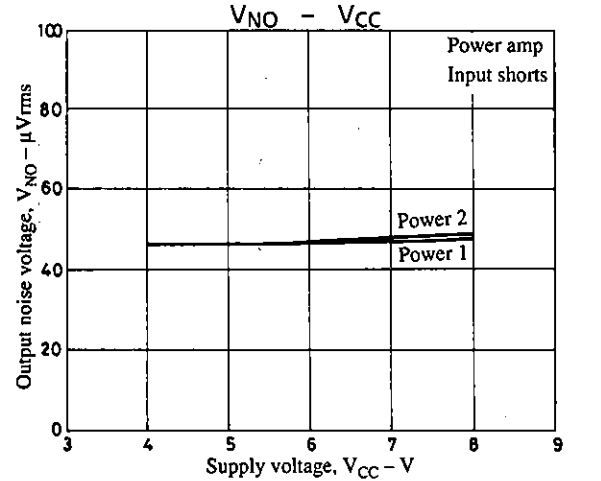
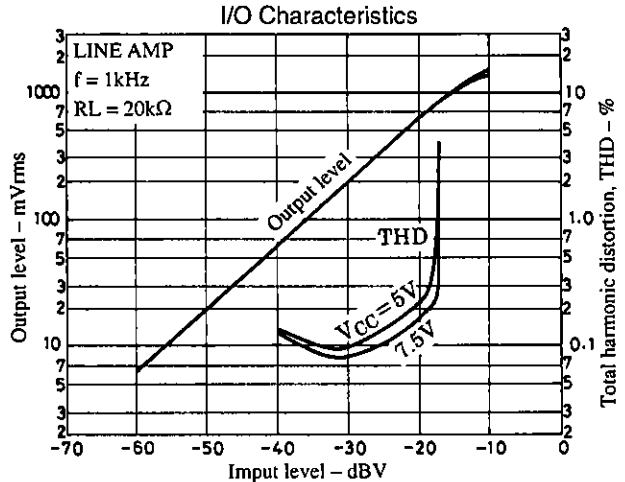
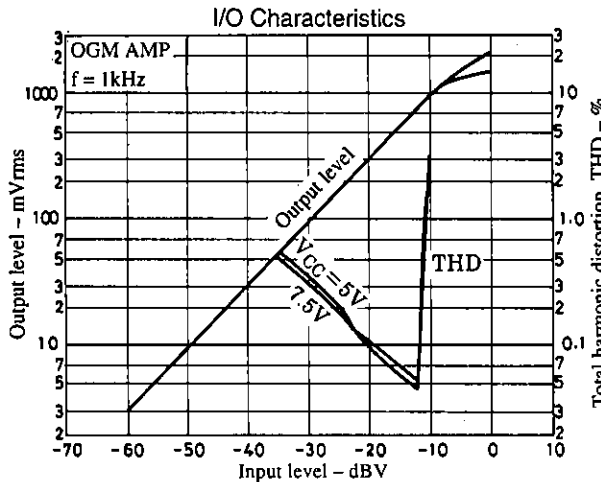
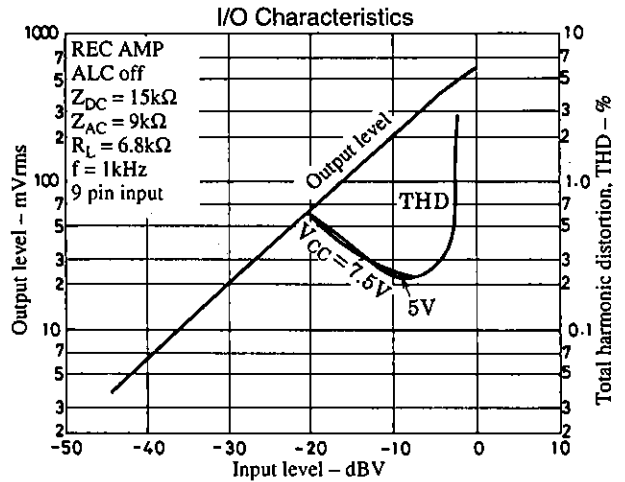
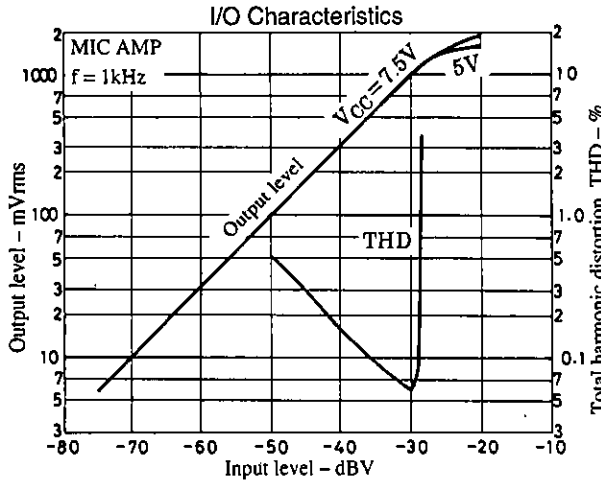

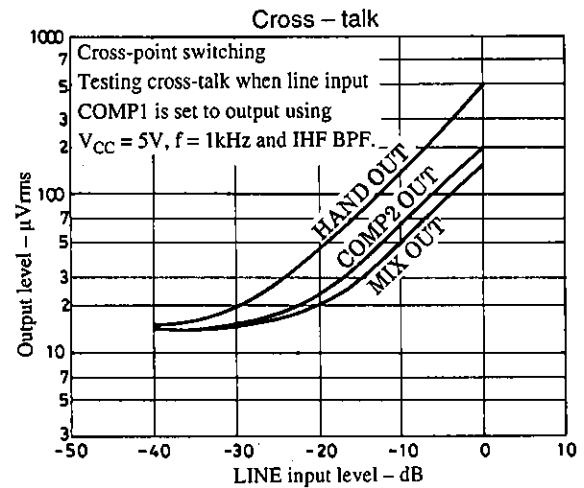
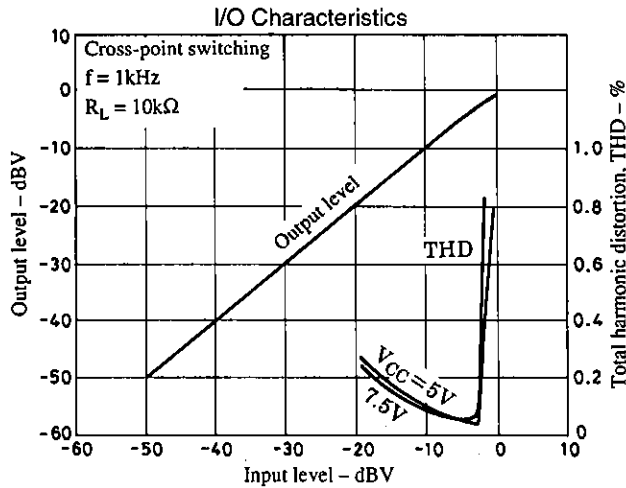
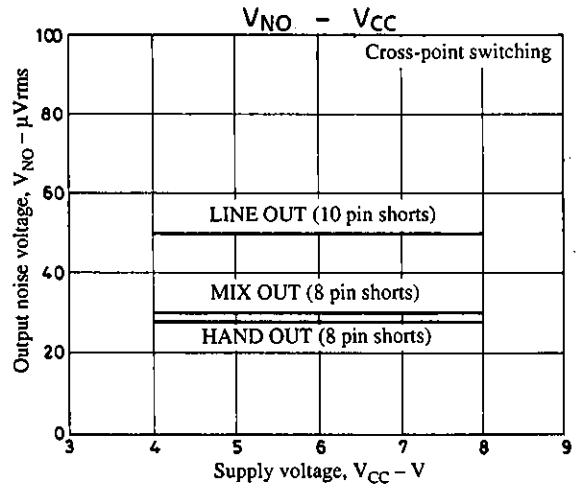
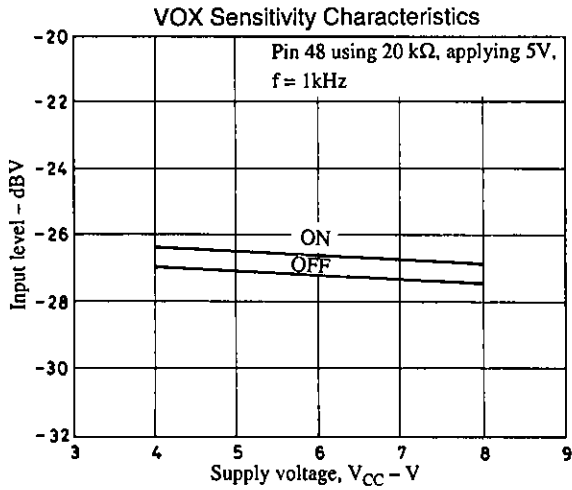

■ No products described or contained herein are intended for use in surgical implants, life-support systems, aerospace equipment, nuclear power control systems, vehicles, disaster/crime-prevention equipment and the like, the failure of which may directly or indirectly cause injury, death or property loss.

■ Anyone purchasing any products described or contained herein for an above-mentioned use shall:

- ① Accept full responsibility and indemnify and defend SANYO ELECTRIC CO., LTD., its affiliates, subsidiaries and distributors and all their officers and employees, jointly and severally, against any and all claims and litigation and all damages, cost and expenses associated with such use:
- ② Not impose any responsibility for any fault or negligence which may be cited in any such claim or litigation on SANYO ELECTRIC CO., LTD., its affiliates, subsidiaries and distributors or any of their officers and employees jointly or severally.

■ Information (including circuit diagrams and circuit parameters) herein is for example only; it is not guaranteed for volume production. SANYO believes information herein is accurate and reliable, but no guarantees are made or implied regarding its use or any infringements of intellectual property rights or other rights of third parties.