



No. 4024

LA4534M

3V CD Headphone-stereo Power Amp

The LA4534M is a low noise, low distortion headphone-stereo power IC designed for use in a portable CD.

Features

- Low power consumption
- Can drive 16-Ω load
- Excellent performance with reduced supply voltage
- Excellent ripple rejection
- Power switch function, built-in muting circuit
- Low noise (7 μV), low gain (11 dB)

Pinout

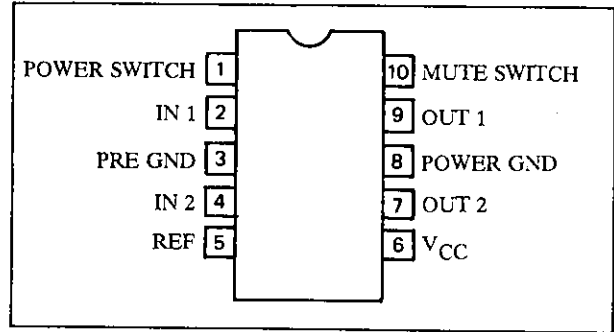

Package Dimensions 3086A

(unit: mm)

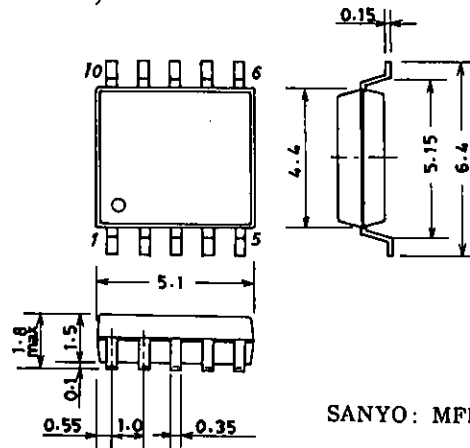

SANYO: MFP10S

LA4534M

Maximum Ratings at Ta = 25°C

				unit
Maximum Supply Voltage	V _{CC} max	Quiescent time	4.5	V
Allowable Power Dissipation	Pd max		300	mW
Operating Temperature	Topg		-20 to +75	°C
Storage Temperature	Tstg		-40 to +125	°C

Operating Conditions at Ta = 25°C

				unit
Recommended Supply Voltage	V _{CC}		3.0	V
Operating Voltage Range	V _{CC} op		1.6 to 4.0	V
Recommended Load Impedance	R _L		16 to 32	Ω

Operating Characteristics at Ta = 25°C, R_L = 16 Ω, R_g = 600 Ω, Measurements taken with specified circuit

			min	typ	max	unit
Quiescent Current	I _{cco} (1)	V _{CC} = 2.4 V, Quiescent time		5.4	10	mA
	I _{cco} (2)	V _{CC} = 4.5 V, Pin 10 to GND		1.1	2.0	mA
	I _{cco} (3)	V _{CC} = 4.5 V, Pin 1 to GND			1.0	μA
Voltage Gain	VG (1)	V _{CC} = 2.4 V, f = 1 kHz, V _O = -10 dBm	9	11	13	dB
	VG (2)	V _{CC} = 1.6 V, f = 1 kHz, V _O = -20 dBm	9	11	13	dB
Voltage Gain Variations	ΔVG (1)	V _{CC} = 2.4 V, f = 1 kHz, V _O = -10 dBm			1.0	dB
	ΔVG (2)	V _{CC} = 1.6 V, f = 1 kHz, V _O = -20 dBm			1.0	dB
Total Harmonic Distortion	THD	V _{CC} = 2.0 V, f = 1 kHz, P _O = 1 mW		0.08	0.24	%
Output Power	P _O	V _{CC} = 3.0 V, f = 1 kHz, THD = 10%	25	50		mW
Crosstalk	CT	V _{CC} = 2.4 V, f = 1 kHz, R _g = 1 kΩ, V _O = -10 dBm	40	50		dB
Ripple Rejection	SVRR	V _{CC} = 1.6 V, f = 100 Hz, R _g = 1 kΩ, V _R = -20 dBm, BPF = 100 Hz	50	70		dB
Output Noise Voltage	V _{NO}	V _{CC} = 4.5 V, R _g = 1 kΩ, BPF = 20 Hz to 20 kHz		7	20	μV
Power Off Effect	V _O (off)	V _{CC} = 1.6 V, f = 100 Hz, Pin 1 to GND, V _i = -10 dBm			-80	dBm
Mute Effect	V _O (MT)	V _{CC} = 1.6 V, f = 100 Hz, Pin 10 to GND, V _i = -10 dBm			-80	dBm
Power On Current Sensitivity	I ₁ (on)	V _{CC} = 1.5 V, V ₅ ≥ 0.85 V		0.05	1.0	μA
Power Off Voltage Sensitivity	V ₁ (off)	V _{CC} = 1.5 V, V ₅ ≤ 0.1 V	0.5	0.6		V
Mute Off Current Sensitivity	I ₁₀ (off)	V _{CC} = 1.5 V, V ₅ ≥ 0.85 V		0.2	1.0	μA
Mute On Voltage Sensitivity	V ₁₀ (on)	V _{CC} = 1.5 V, V ₅ ≤ 0.1 V	0.5	0.65		V

Note) Quiescent current is the current flowing into pin 6. Current flowing into pin 1 or 10 is the maximum value and calculated from the equation (V pin -0.5 V)/16 [V/kΩ], increasing total current.

LA4534M

Block Diagram

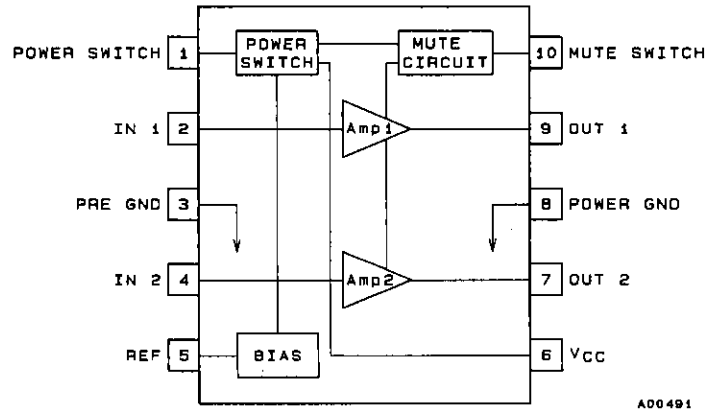

Test Circuit

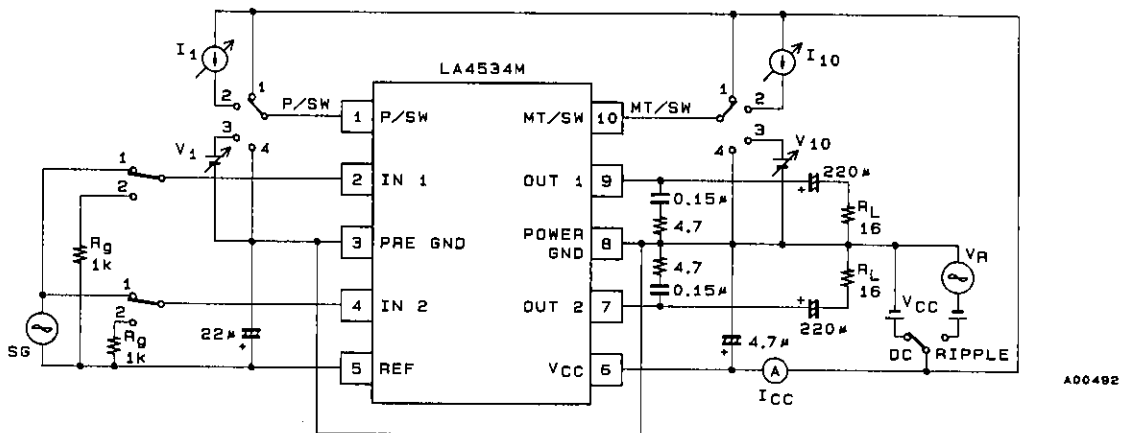

Typical Application

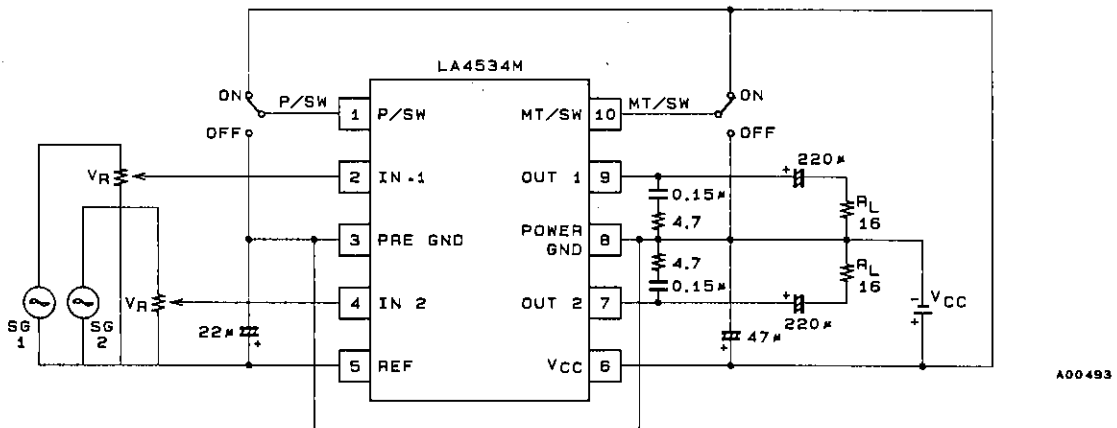

Unit (resistance: Ω, capacitance: F)

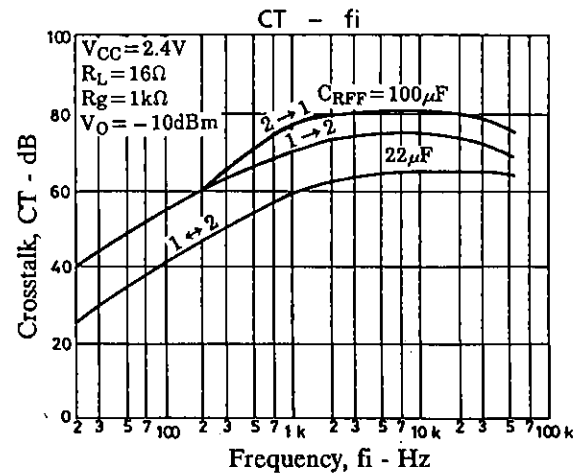
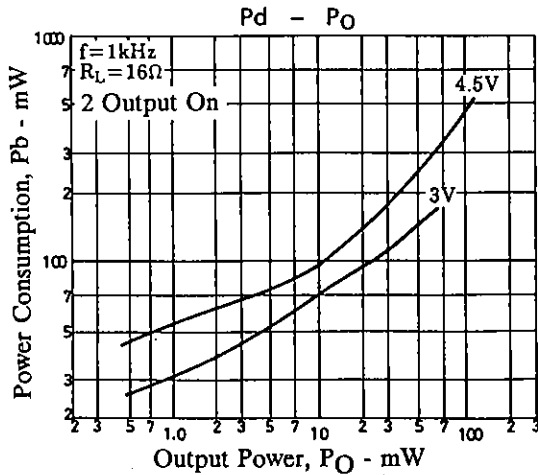
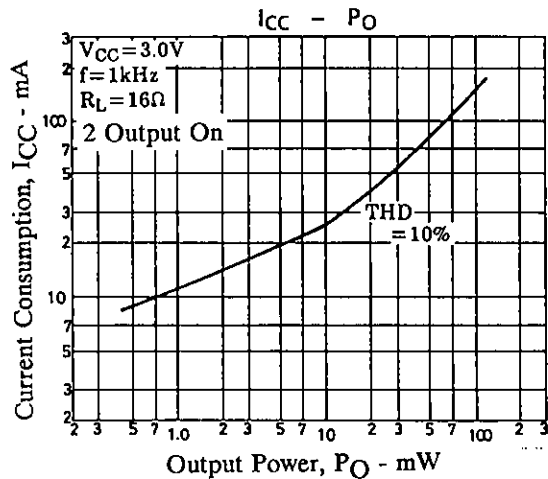
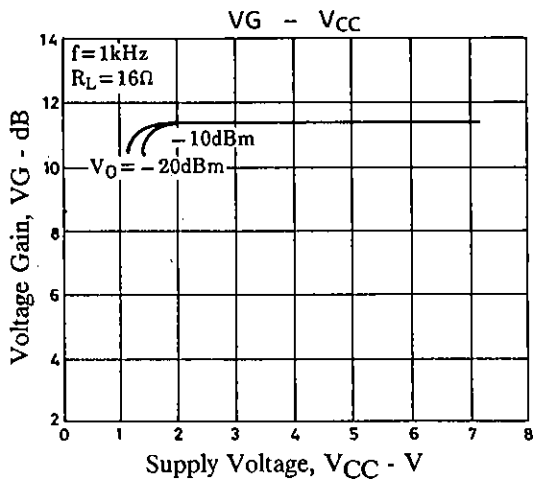
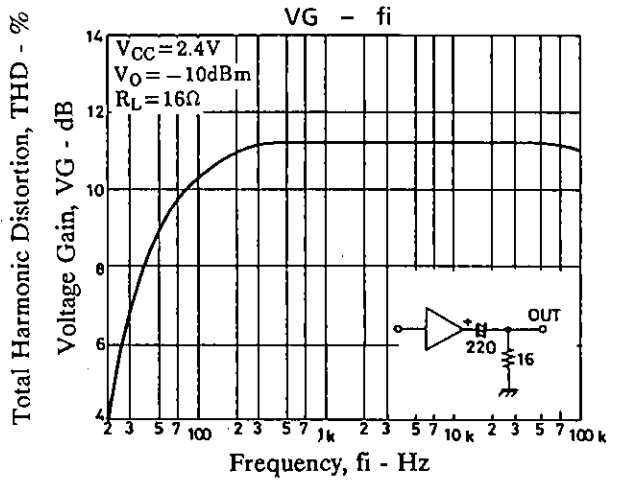
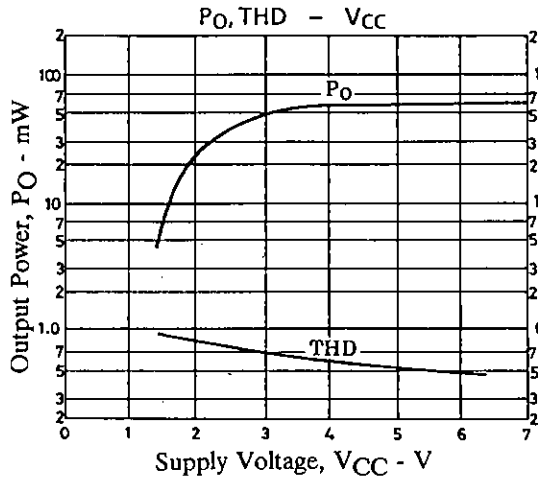
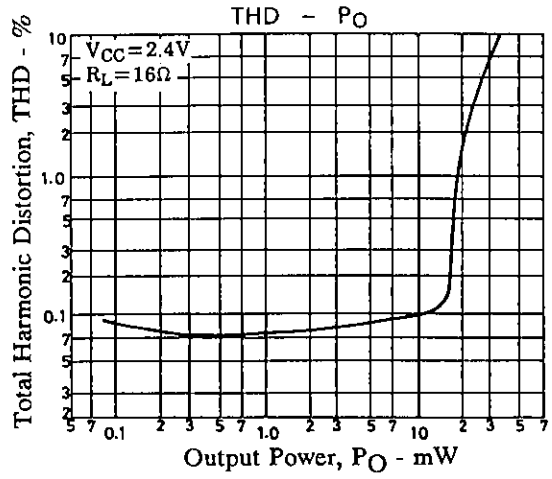
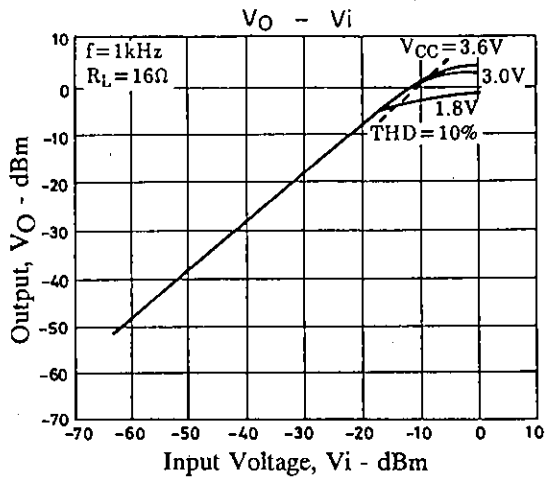

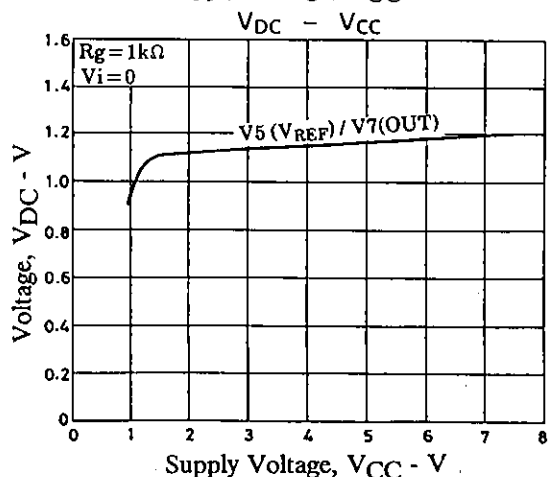
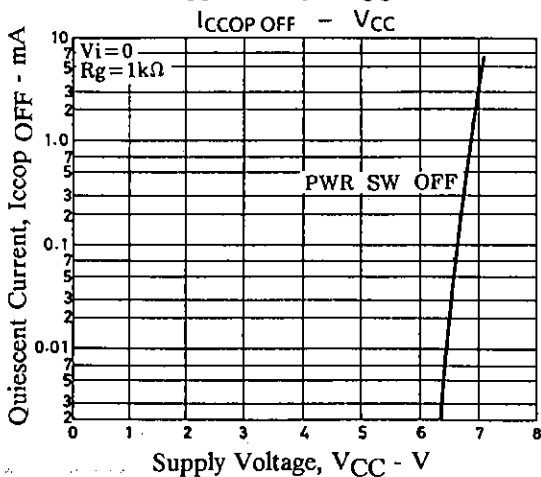
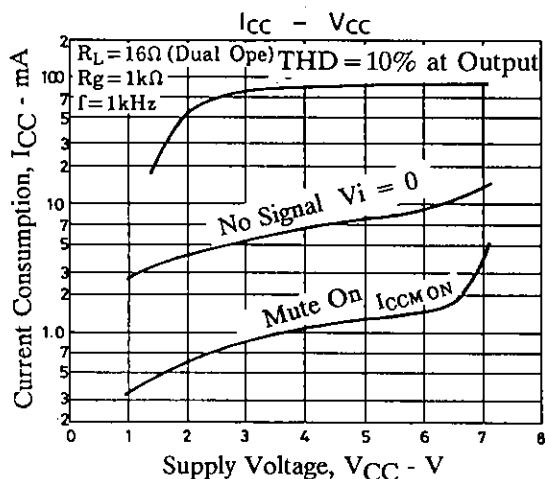
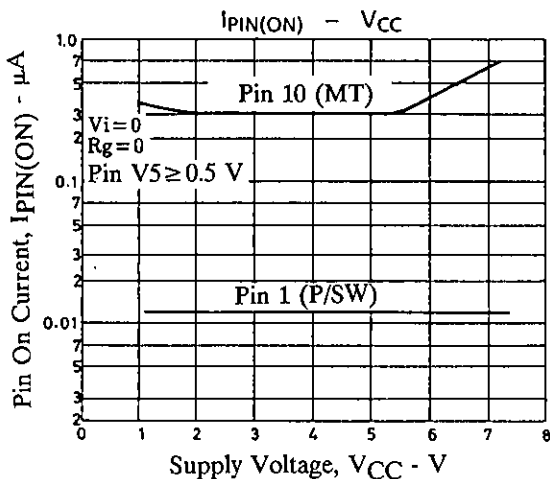
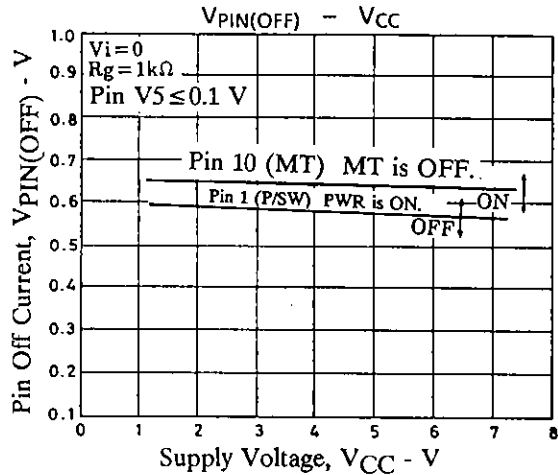
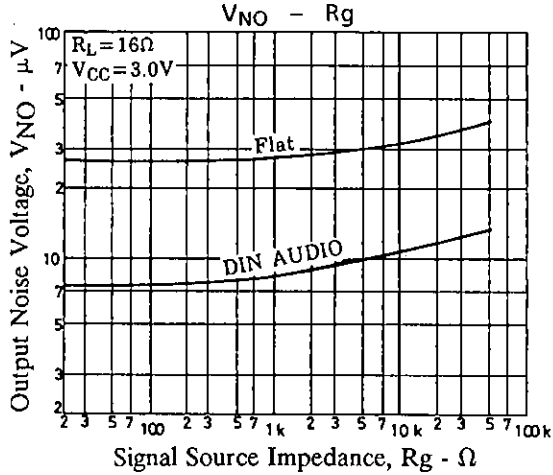
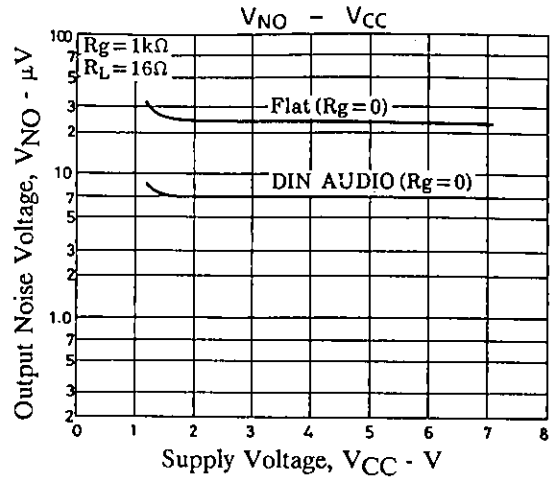
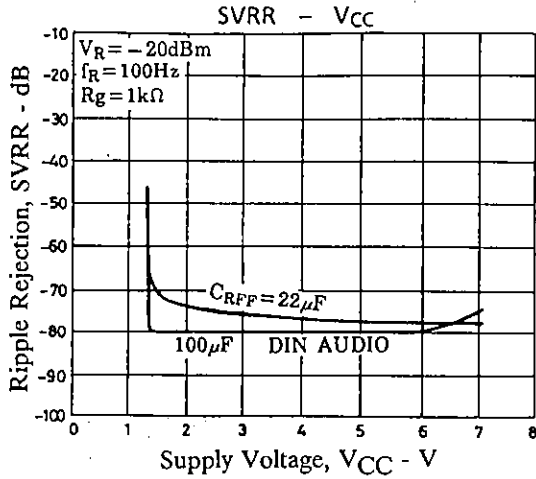

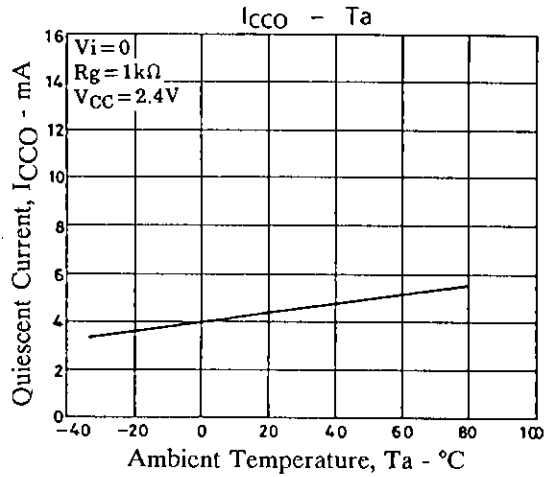
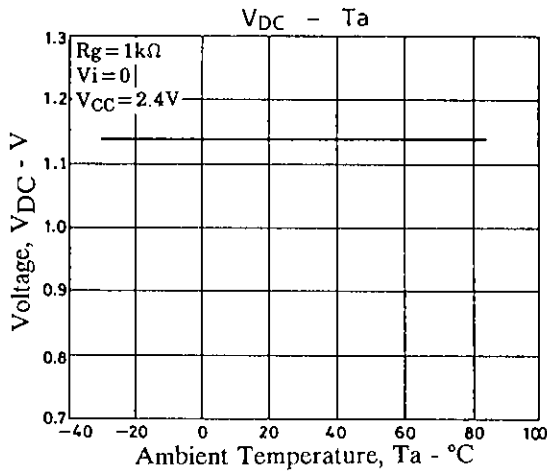
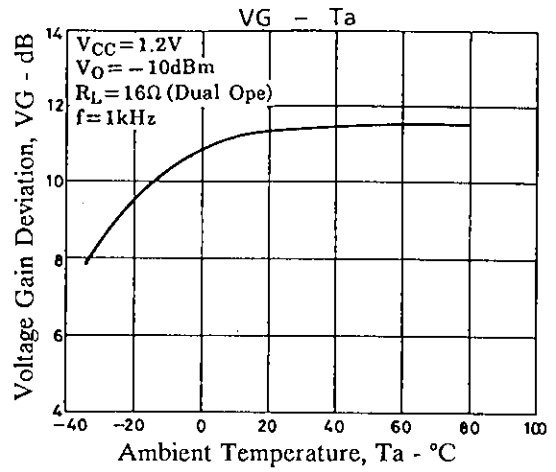
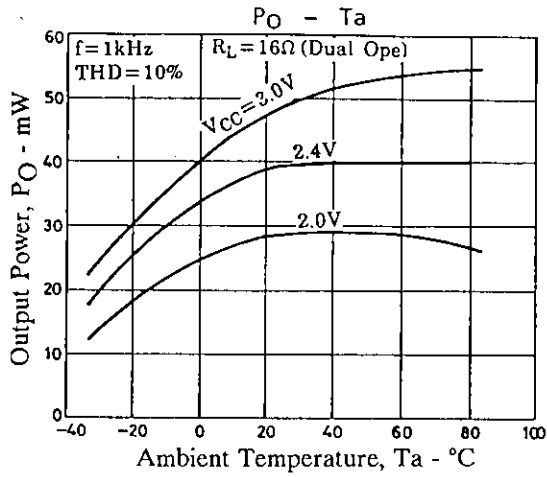

P.S.W OFF

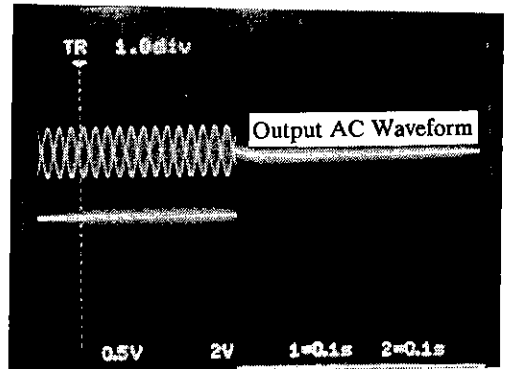
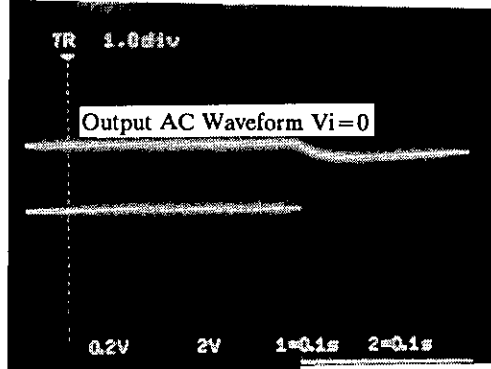

P.S.W ON

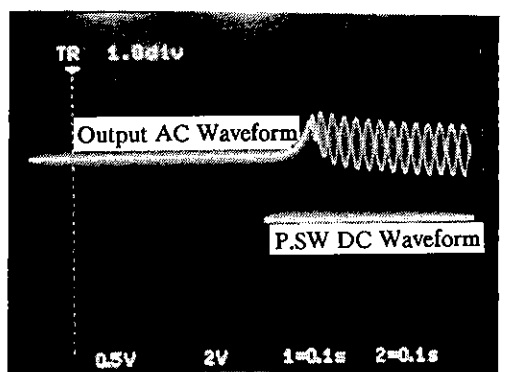
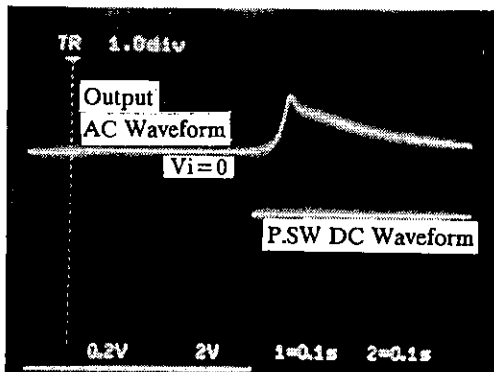

M.SW OFF

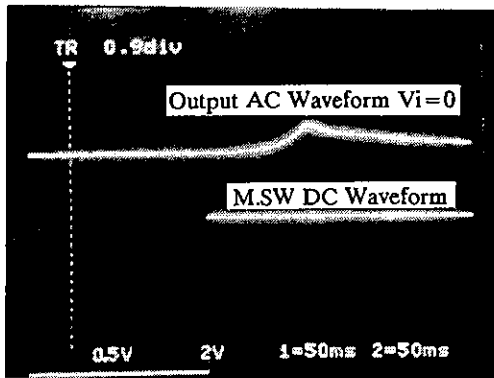

M.SW OFF

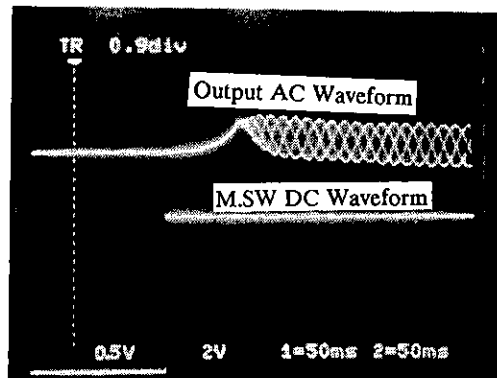

M.SW OFF

M.SW ON

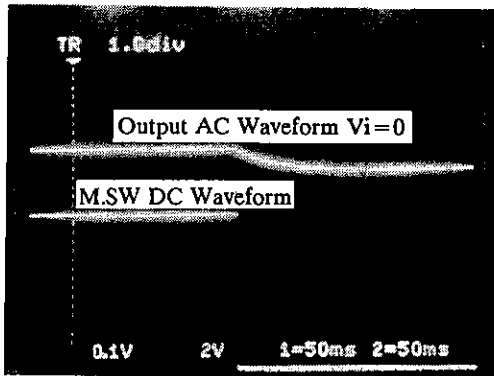

M.SW ON

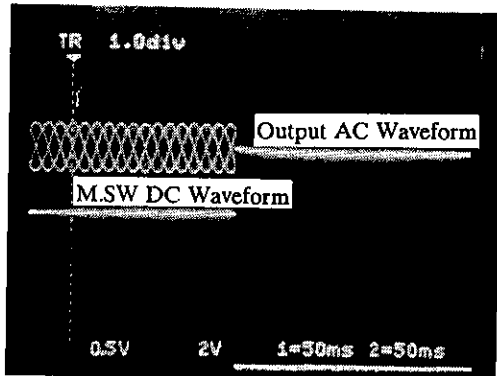

M.SW ON

Note on Application

Minimizing pop noise

The switching sequence shown below will generate minimum pop noises.

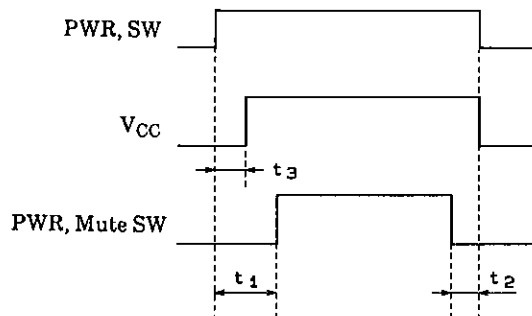

A00500

For minimum pop noise, the PWR mute switch should be turned on t_1 (approx. 0.1 sec) after power-on and turned off t_2 (approx. 0.1 sec) before power-off. That is, turn on and off the PWR mute switch while both power and V_{CC} are on.

- No products described or contained herein are intended for use in surgical implants, life-support systems, aerospace equipment, nuclear power control systems, vehicles, disaster/crime-prevention equipment and the like, the failure of which may directly or indirectly cause injury, death or property loss.
- Anyone purchasing any products described or contained herein for an above-mentioned use shall:
 - ① Accept full responsibility and indemnify and defend SANYO ELECTRIC CO., LTD., its affiliates, subsidiaries and distributors and all their officers and employees, jointly and severally, against any and all claims and litigation and all damages, cost and expenses associated with such use:
 - ② Not impose any responsibility for any fault or negligence which may be cited in any such claim or litigation on SANYO ELECTRIC CO., LTD., its affiliates, subsidiaries and distributors or any of their officers and employees jointly or severally.
- Information (including circuit diagrams and circuit parameters) herein is for example only; it is not guaranteed for volume production. SANYO believes information herein is accurate and reliable, but no guarantees are made or implied regarding its use or any infringements of intellectual property rights or other rights of third parties.