

SANYO

No. ※4975

LC9945**1/6 Inch Optical Size CCIR Black-and-White
Solid-State Imaging Device****Preliminary****Overview**

The LC9945 is a 1/6 inch optical size frame transfer CCD (charge-coupled device) solid-state imaging device.

Features

- Effective number of pixels [total pixels]:
258 × 299 [275 × 306] (H × V)
- Number of optical blacks
Horizontal direction: Front: 3 pixels
Rear: 14 pixels
Vertical direction: Front: 3 pixels
Rear: 3 pixels
- Horizontal resolution: 190 TV lines
- High sensitivity and low noise
- Blooming is suppressed and smear is minimal.
- No residual images, burning in, or figure distortion
- Miniature size supports compact application designs.
- Superlative resistance to vibration, long life, and high reliability
- The LC9945 is provided in a 20-pin half-pitch completely transparent DIP package.
- Horizontal shift register, 5 V operation
- Can be used with a variable-speed electronic shutter

Device Structure

- 1/6 inch optical size frame transfer CCD image sensor
- Unit cell size: 9.7 μm (H) × 6.2 μm (V)
- Chip size: 3.79 mm (H) × 4.44 mm (V)
- Parallel gate CCD sensor
- Built-in high-sensitivity output amplifier

Note: Please contact your Sanyo sales representative in advance if you plan to design an optical system for this product.

Package Dimensions

unit: mm

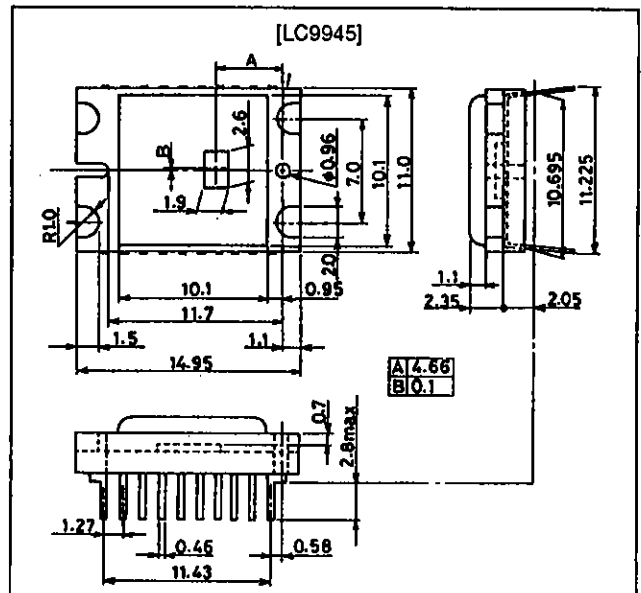
3209**SANYO Electric Co., Ltd. Semiconductor Business Headquarters**

TOKYO OFFICE Tokyo Bldg., 1-10, 1 Chome, Ueno, Taito-ku, TOKYO, 110 JAPAN

Specifications

Absolute Maximum Ratings at Ta = 25°C

Parameter	Symbol	Conditions	Ratings	Unit
Maximum supply voltage	V _{DD}	V _{PW} = 0 V	-0.3 to +18	V
	NSUB	V _{PW} = 0 V	-0.3 to +50	V
Horizontal clock pin	φR	V _{PW} = 0 V	-0.3 to +18	V
Other clock pins	—	V _{PW} = 0 V	-15 to +18	V
All other pins	—	V _{PW} = 0 V	-0.3 to +10	V
Operating temperature	T _{opr}		-10 to +55	°C
Storage temperature	T _{stg}		-30 to +80	°C

Block Diagram

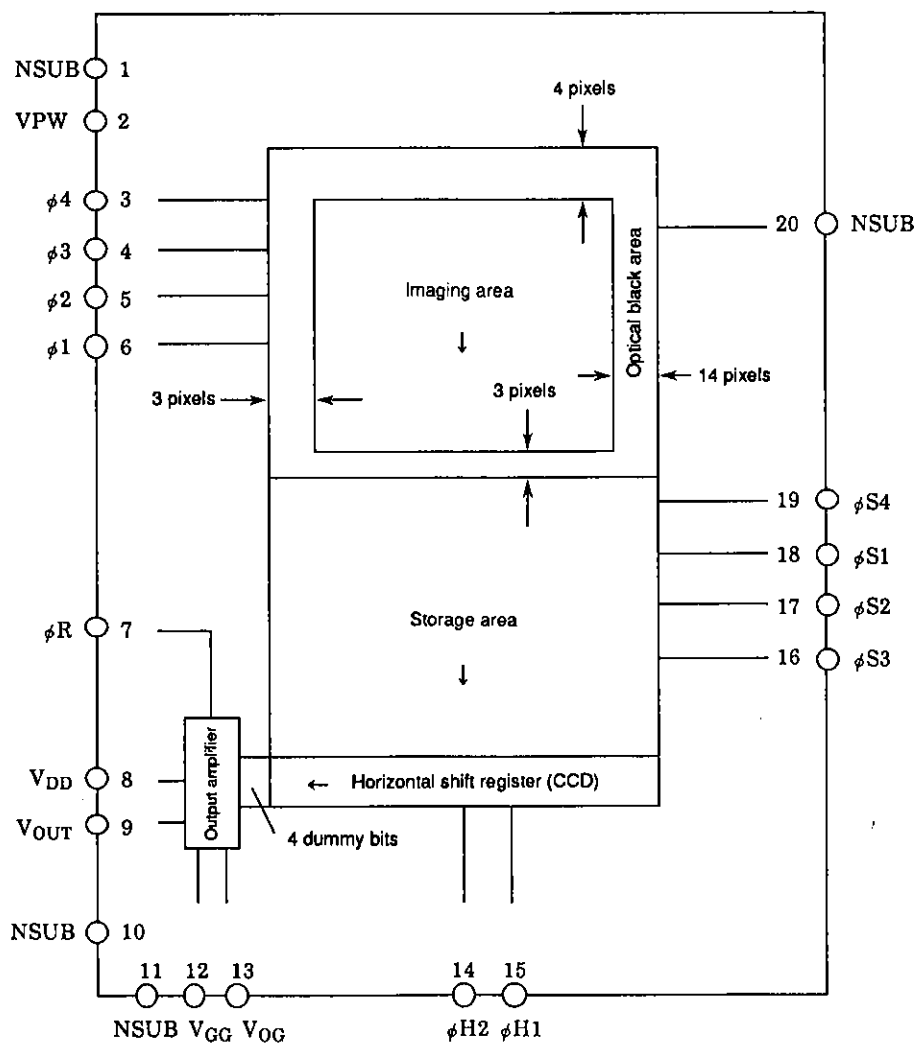

Pin Assignment

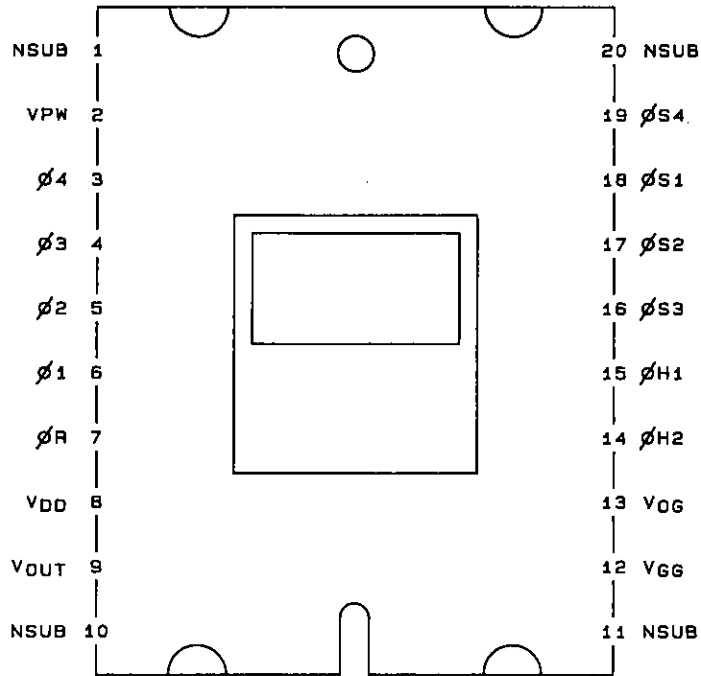

Top View

A02882

Pin Functions

Pin No.	Symbol	Pin function	Pin No.	Symbol	Pin function
1	NSUB	N-substrate	20	NSUB	N-substrate
2	VPW	P-well	19	øS4	Storage area clock
3	ø4	Imaging area clock	18	øS1	Storage area clock
4	ø3	Imaging area clock	17	øS2	Storage area clock
5	ø2	Imaging area clock	16	øS3	Storage area clock
6	ø1	Imaging area clock	15	øH1	Horizontal shift register clock
7	øR	Reset gate	14	øH2	Horizontal shift register clock
8	V _{DD}	Power supply	13	V _{OG}	CCD output gate
9	V _{OUT}	CCD output	12	V _{GG}	Load gate
10	NSUB	N-substrate	11	NSUB	N-substrate

■ No products described or contained herein are intended for use in surgical implants, life-support systems, aerospace equipment, nuclear power control systems, vehicles, disaster/crime-prevention equipment and the like, the failure of which may directly or indirectly cause injury, death or property loss.

■ Anyone purchasing any products described or contained herein for an above-mentioned use shall:

- ① Accept full responsibility and indemnify and defend SANYO ELECTRIC CO., LTD., its affiliates, subsidiaries and distributors and all their officers and employees, jointly and severally, against any and all claims and litigation and all damages, cost and expenses associated with such use:
- ② Not impose any responsibility for any fault or negligence which may be cited in any such claim or litigation on SANYO ELECTRIC CO., LTD., its affiliates, subsidiaries and distributors or any of their officers and employees jointly or severally.

■ Information (including circuit diagrams and circuit parameters) herein is for example only; it is not guaranteed for volume production. SANYO believes information herein is accurate and reliable, but no guarantees are made or implied regarding its use or any infringements of intellectual property rights or other rights of third parties.

Clock Voltage/Frame Shift Frequency = 3.55 MHz

Parameter	Symbol	Conditions	min	typ	max	Unit
Imaging block pulses: $\phi 1$, $\phi 2$, $\phi 3$, $\phi 4$						
Pulse amplitude	V_{PIF}		14.5	15.0	15.5	V
Low level	V_{LIF}		-10.0	-9.5	-9.0	V
Storage block pulses: $\phi S1$, $\phi S2$						
Pulse amplitude	V_{PSL}		14.5	15.0	15.5	V
Low level	V_{LSL}		-5.5	-5.0	-4.5	V
Storage block pulses: $\phi S3$, $\phi S4$						
Pulse amplitude	V_{PSH}		14.5	15.0	15.5	V
Low level	V_{LSH}		-6.5	-6.0	-5.5	V
Horizontal transfer pulses: $\phi H1$, $\phi H2$						
Pulse amplitude	V_{PH}		4.75		5.25	V
Low level	V_{LH}		0	0	0.5	V
Reset gate: ϕR						
Pulse amplitude	V_{PR}		4.75		5.25	V
Low level	V_{LR}		2.0	2.5	3.0	V
Substrate pulse: ϕSUB						
High level	V_{HSUB}	See Figure 1	29.0	30.0	31.0	V
Low level	V_{LSUB}	See Figure 1	14.5	15.0	15.5	V

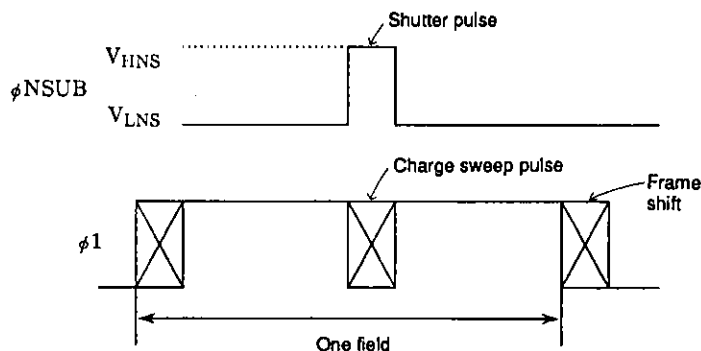

Fig. 1

Bias Conditions

Parameter	Symbol	Conditions	min	typ	max	Unit
P-well	V_{PW}			0		V
Output circuit voltage	V_{DD}	*1	14.5	15.0	15.5	V
	V_{GG}		3.0	4.0	4.2	V
OG bias	V_{OG}	*2	—	—	—	V

- Note: 1. This level must not become higher than the substrate pulse low level V_{LSUB} .
 2. Connect V_{OG} to ground through a 0.1 μF capacitor. (See Figure 2.)

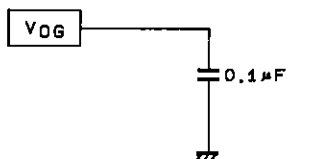

Fig. 2

DC Characteristics

Parameter	Symbol	Conditions	min	typ	max	Unit
DC operating current	I_{DD}			7.0	8.0	mA

Drive Pulse Waveform Standards

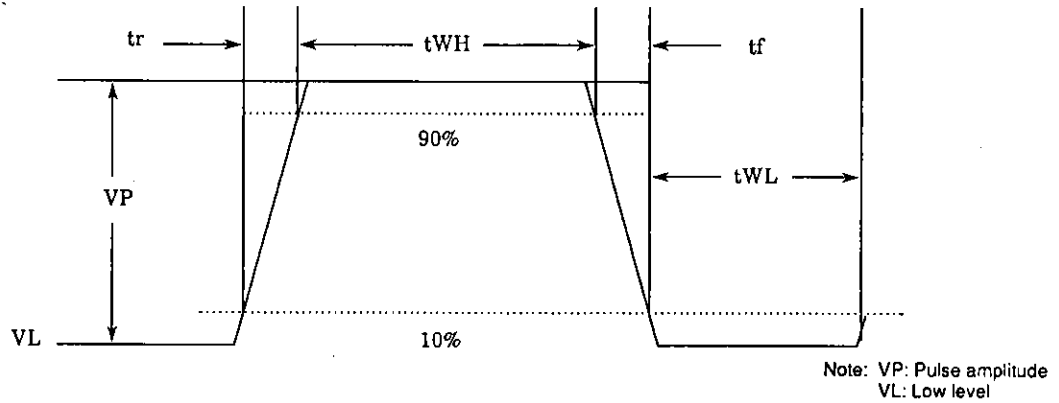

Fig. 3 Pulse Waveform

Symbol	tWH	tWL	tr	tf	Unit	Notes
	typ	typ	typ	typ		
ø1	110	110	30	30	ns	During frame transfer When the frame shift frequency is 3.55 MHz
ø2	110	110	30	30		
ø3	110	110	30	30		
ø4	110	110	30	30		
øS1	110	110	30	30	ns	During frame transfer When the frame shift frequency is 3.55 MHz
øS2	110	110	30	30		
øS3	110	110	30	30		
øS4	110	110	30	30		
øS1	1.8	62.2	20	20	ns	During 1H line vertical transfer The figures enclosed in dark lines are in μ s units.
øS2	1.8	62.2	20	20		
øS3	62.2	1.8	20	20		
øS4	62.2	1.8	20	20		
øR	36	167	4	4	ns	Reset pulse
øH1	101	102	4	4		During horizontal transfer
øH2	101	102	4	4		

Imaging Characteristics at Ta = 25°C

Parameter	Symbol	Conditions	min	typ	max	Unit
Sensitivity	S	Test method 1	75			mV
Video signal non-uniformity	VF	Test method 2			15	%
Saturated signal level	Vsat	Test method 3	500			mV
Smear	SM	Test method 4*		0.02		%
Dark signal	Vdrk	Test method 5, Ta = 55°C			10	mV
γ characteristics	γ			1		—

Note: For a frame shift frequency of 3.55 MHz and a storage time of 1/50 s.

Test Methods

The following tests are performed with the CCD device to be measured mounted on the Sanyo evaluation board. Video levels are for the evaluation board VIDEO OUT unless otherwise noted. The VIDEO OUT signal must be terminated at 75 Ω.

1. Sensitivity

Set up a CCV31F pattern box (Dai Nippon Printing Co., Ltd., intensity: 1320 NT, color temperature: 3100°K) with no pattern, and take an image with a 1 mm C-500 thickness infrared blocking filter mounted in front of a Fujinon HF16A lens. Set the lens aperture to f11, and set the separation between the lens and the pattern box to be 50 cm. Measure the CCD output signal from the center of the image in this state.

2. Video signal non-uniformity

Measure the CCD output signal for the nine points in the image indicated in Figure 4 in the test method 1 setup state. Derive the non-uniformity (VF) from formula 1.

$$VF = \frac{V_{max} - V_{min}}{(V1 + V2 + V3 + V4 + V5 + V6 + V7 + V8 + V9) / 9} \times 100$$

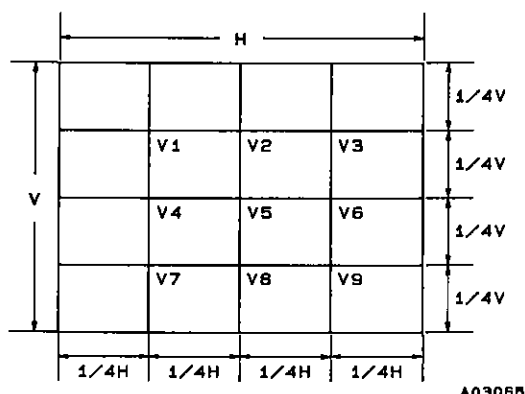

Fig. 4 Image Measurement Points

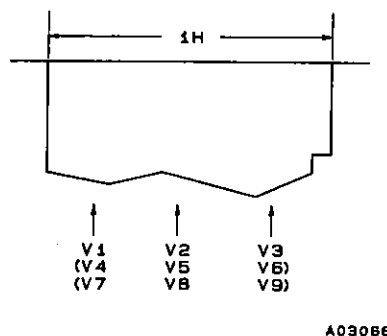

Fig. 5 1H Measurement Points

3. Saturated signal level

In the test method 1 setup state, remove the lens to saturate the output signal. Measure the CCD output signal from the center of the image at this time.

4. Smear

- Place a 1/10 V chart in front of a halogen light source as described below and take the image.
- Adjust the image (input) light intensity using ND filters so that the output signal at point A, i.e., the CCD output, becomes 250 mV.
- Remove the ND filter and measure the output value for the first line (at point B) in the CCD output signal.

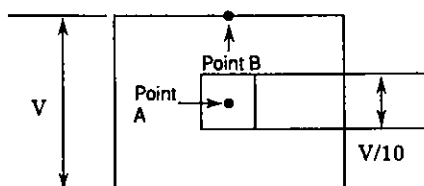

Fig. 6

$$SM = \frac{VB \times TND}{250} \times 100 (\%)$$

VB: The amount of smear (mV) at point B
TND: Transmittance of the ND filter

5. Dark signal

Block all light falling on the imaging element surface and measure the CCD output signal from the center of the image. At this time, do not take the difference between the signal level and the optical black segment level, but rather take the difference with the no signal level that has no pixel information. See Figure 7.

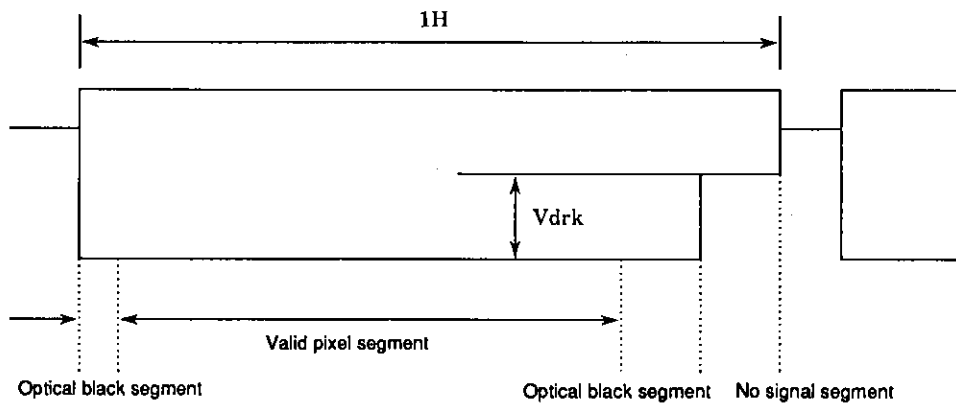
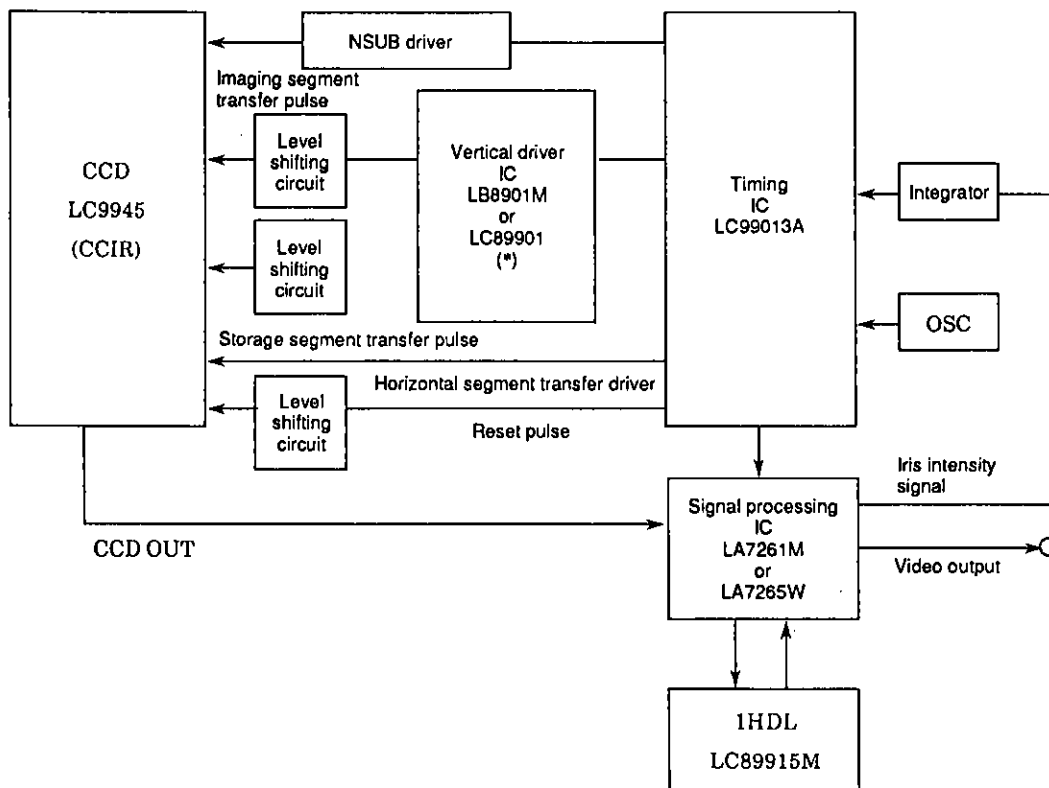

Fig. 7 Structure of the 1H Period

CCD B&W Camera Block Diagram



Note: The imaging segment transfer pulse level shifting circuit is not required if the LC89901 is used.

Fig. 8 CCD B&W Camera Block Diagram

Block Descriptions

OSC	Generates the basic frequency (14.1875 MHz) for synchronization signals and timing pulses
Timing pulse generator IC	Generates the pulses required for the video signal (SYNC, blanking, etc.) and the pulses required for driving the CCD. This IC includes a built-in CCD horizontal driver and provides an electronic iris function.
Driver IC	Amplifies the pulses described above to their prescribed levels and drives the CCD device.
Level shifting circuit	Drive pulse level shifter
Signal processing IC	Video signal processing, including sample and hold, clamping, AGC, gamma correction, white clipping, and pedestal addition.

Notes on Handling and Mounting

1. Static discharge prevention

The following measures for static discharge prevention must be taken, since the sensor is easily destroyed by static discharges.

- Personnel and all equipment must be grounded when handling the sensor. For safety, personnel should be grounded through a resistor of about 1 M Ω . (The use of wrist straps is recommended.)
- Work should be performed either with bare hands or antistatic gloves. Antistatic work uniforms should be used. Also, conductive shoes should be worn.
- Spread conductive mats on the work place floors and on workbenches so that static charges do not arise.
- We recommend using an ionized air blower to remove static charges when handling CCD sensors.
- Use antistatic processed boxes to transport printed circuit boards with mounted CCD devices.

2. Soldering

- The package temperature must never exceed 80°C.
- In addition to static discharges, CCD sensors are also easily destroyed by thermal stress. The soldering iron tip temperature should be under 300°C when mounting on a printed circuit board, and 2 seconds per pin should be set as the target soldering time.
- Only use soldering irons that have a temperature controller that holds the soldering iron tip at a fixed temperature.
- Use extra care to avoid heating the element to over 80°C when re-soldering or removing a CCD element.

3. Dirt and contamination

- Work should be performed in a clean environment. (A class 1000 level is appropriate.)
- Do not touch the package surface or allow any objects to contact the surface. If dirt or other contamination gets on the package surface remove it with an air blower. (We recommend the use of an ionized air blower if possible.)
- Oily or greasy contamination can be removed with a cotton swab dipped in ethyl alcohol. Be extremely careful not to scratch the package surface.
- Store CCD devices in their special-purpose cases to avoid dirt and other contamination and to prevent condensation when transporting into a room with a radically differing temperature, warm or cool the device in advance.
- For devices supplied with protective tape, remove the tape immediately prior to use only after thorough antistatic measures have been implemented. Do not reuse the protective tape.

4. Storage methods

- Do not subject CCD products to intense light for extended periods.
- Since severe high temperature/high humidity conditions can adversely influence device characteristics, avoid storing CCD products in such environments.
- Since CCD sensors are high-precision optical components, they must be protected from mechanical shocks.

5. Notes on mounting

- The use of a lens with an optical size of over 1/6 inch can result in flare. Consult your Sanyo sales representative before selecting a lens.
- This product is mounted in a fully clear plastic package, and is susceptible to light entering from the back of the printed circuit board that it is mounted on. Therefore end products must provide adequate protection from stray light.