

SANYO	No.3142A	2SC4523
	NPN Epitaxial Planar Silicon Transistor	
High-Speed Switching Applications		

Features

- Adoption of FBET, MBIT processes
- Large current capacity
- Low collector-to-emitter saturation voltage
- Fast switching speed

Absolute Maximum Ratings at Ta = 25°C

			unit
Collector to Base Voltage	V _{CB0}	60	V
Collector to Emitter Voltage	V _{CEO}	45	V
Emitter to Base Voltage	V _{EBO}	5	V
Collector Current	I _C	8	A
Collector Current(Pulse)	I _{CP}	12	A
Collector Dissipation	P _C	1	W
		15	W
Junction Temperature	T _j	150	°C
Storage Temperature	T _{stg}	-55 to +150	°C

T_c = 25°C

Electrical Characteristics at Ta = 25°C

			min	typ	max	unit
Collector Cutoff Current	I _{CBO}	V _{CB} = 45V, I _E = 0			1	μA
Emitter Cutoff Current	I _{EBO}	V _{EB} = 2V, I _C = 0			10	μA
DC Current Gain	h _{FE} (1)	V _{CE} = 2V, I _C = 500mA	100*		400*	
	h _{FE} (2)	V _{CE} = 2V, I _C = 8A	40			
Gain-Bandwidth Product	f _T	V _{CE} = 2V, I _C = 500mA		250		MHz
Output Capacitance	c _{ob}	V _{CB} = 10V, f = 1MHz		65		pF
C-E Saturation Voltage	V _{CE(sat)}	I _C = 4A, I _B = 200mA	0.25	0.7		V
B-E Saturation Voltage	V _{BE(sat)}	I _C = 4A, I _B = 200mA	0.95	1.3		V
C-B Breakdown Voltage	V _{(BR)CBO}	I _C = 100μA, I _E = 0	60			V
C-E Breakdown Voltage	V _{(BR)CEO}	I _C = 1mA, R _{BE} = ∞	45			V
E-B Breakdown Voltage	V _{(BR)EBO}	I _E = 100μA, I _C = 0	5			V
Turn-ON Time	t _{on}	See specified Test Circuit.		50	100	ns
Storage Time	t _{stg}	∞		150	270	ns
Turn-OFF Time	t _{off}	∞		180	350	ns

*: The 2SC4523 is classified by 500mA h_{FE} as follows:

100	R	200	140	S	280	200	T	400
-----	---	-----	-----	---	-----	-----	---	-----

Switching Time Test Circuit

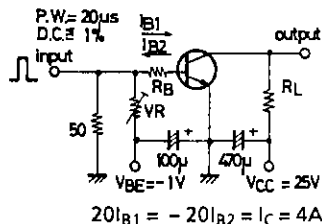

Unit (Resistance : Ω, Capacitance : F)

Package Dimensions 2045B

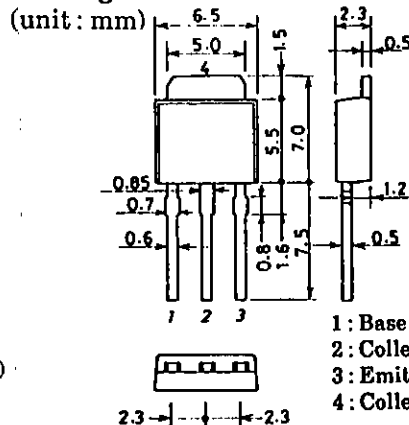

Package Dimensions 2044B

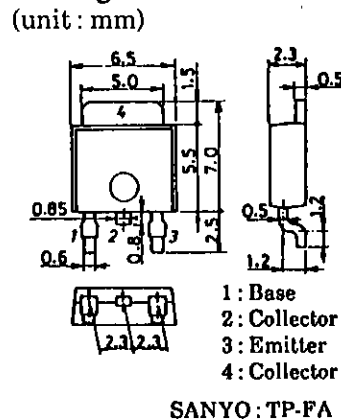

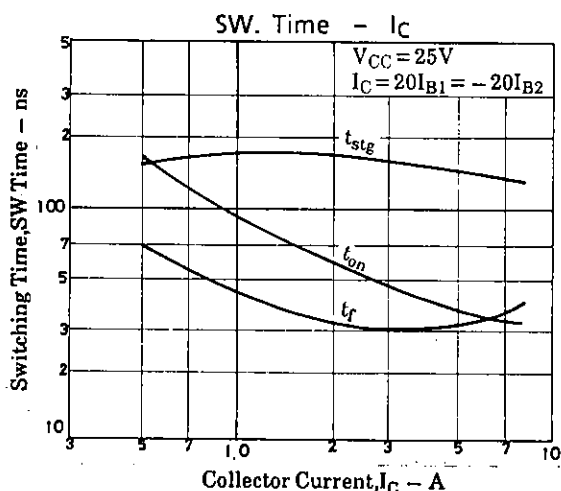
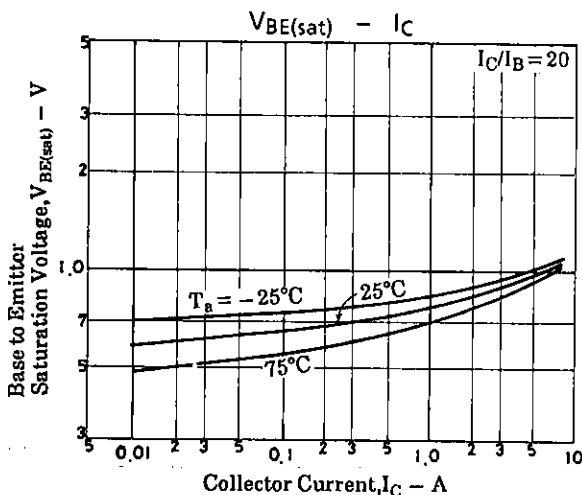
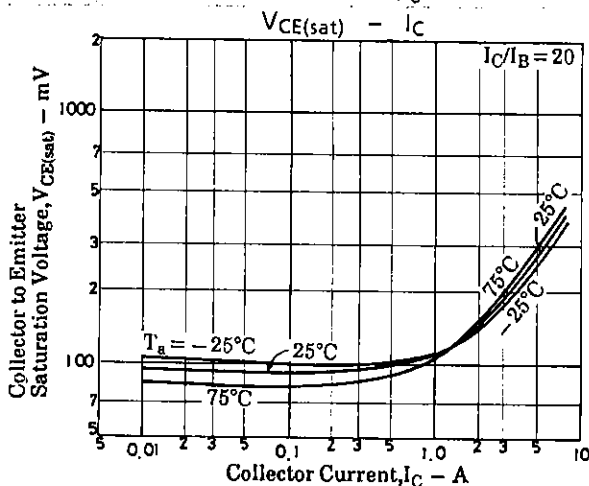
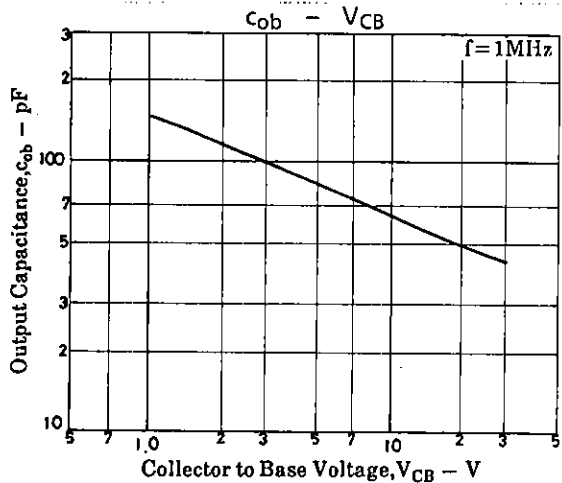
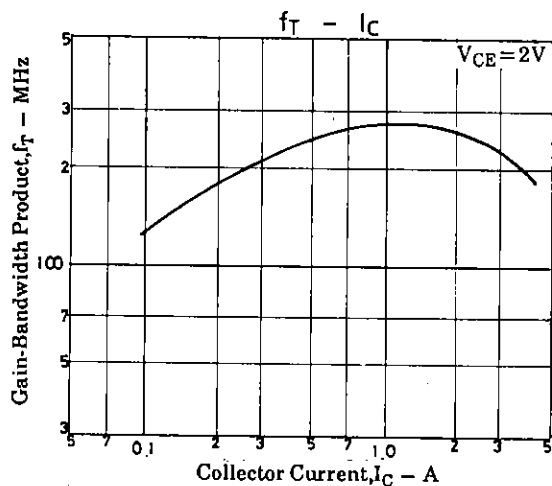
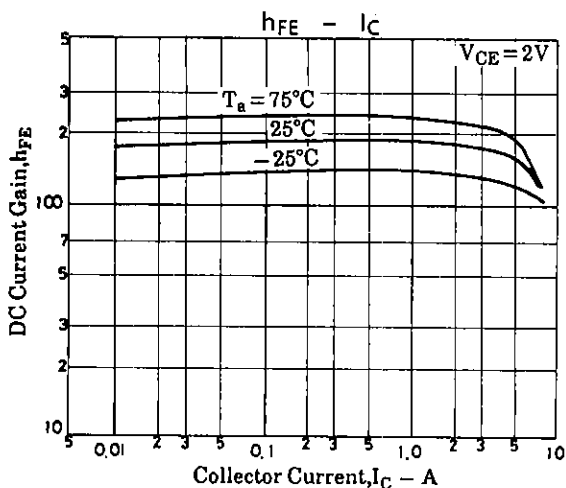
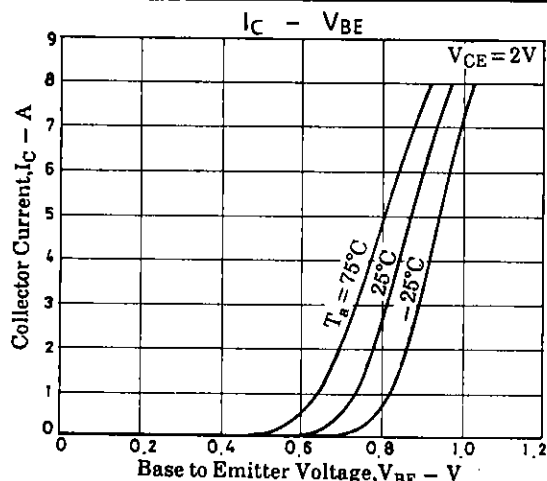
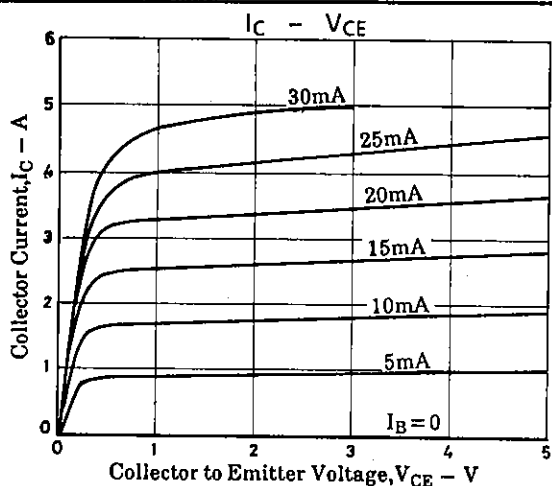

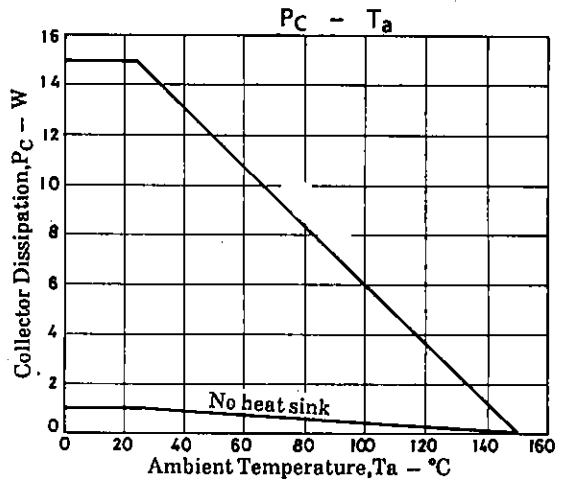
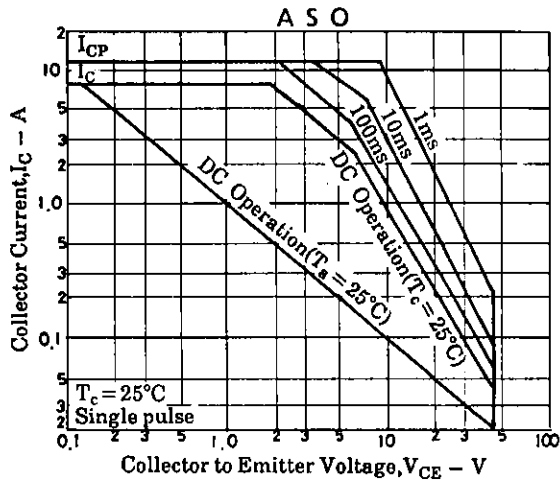

■ No products described or contained herein are intended for use in surgical implants, life-support systems, aerospace equipment, nuclear power control systems, vehicles, disaster/crime-prevention equipment and the like, the failure of which may directly or indirectly cause injury, death or property loss.

■ Anyone purchasing any products described or contained herein for an above-mentioned use shall:

- ① Accept full responsibility and indemnify and defend SANYO ELECTRIC CO., LTD., its affiliates, subsidiaries and distributors and all their officers and employees, jointly and severally, against any and all claims and litigation and all damages, cost and expenses associated with such use;
- ② Not impose any responsibility for any fault or negligence which may be cited in any such claim or litigation on SANYO ELECTRIC CO., LTD., its affiliates, subsidiaries and distributors or any of their officers and employees jointly or severally.

■ Information (including circuit diagrams and circuit parameters) herein is for example only; it is not guaranteed for volume production. SANYO believes information herein is accurate and reliable, but no guarantees are made or implied regarding its use or any infringements of intellectual property rights or other rights of third parties.