

**SANYO**

No. 2636C

**LA4446**Car Stereo-Use  
5.5W 2-Channel AF Power Amp**Features**

- . Dual channels
  - Output: 5.5Wx2(typ)
- . Low pop noise at the time of power supply ON/OFF and good starting balance
- . Good ripple rejection: 46dB(typ)
- . Good channel separation
- . Low residual noise (Rg=0)
- . On-chip protectors
  - a. Thermal protector
  - b. Overvoltage/surge protector
  - c. Adjacent pins (7-8, 6-7) short protector

**Maximum Ratings** at  $T_a=25^\circ\text{C}$ 

				unit
Maximum Supply Voltage	$V_{CC}$ max1	Quiescent ( $t=30\text{s}$ )	25	V
	$V_{CC}$ max2	Operating	18	V
Surge Supply Voltage	$V_{CC}$ surge	$t \leq 0.2\text{s}$	50	V
Maximum Output Current	$I_o$ peak	Per channel	3.5	A
Allowable Power Dissipation	$P_d$ max	See $P_d$ max - $T_a$	15	W
		characteristic.		
Operating Temperature	$T_{opr}$		-20~+75	$^\circ\text{C}$
Storage Temperature	$T_{stg}$		-40~+150	$^\circ\text{C}$

**Operating Conditions** at  $T_a=25^\circ\text{C}$ 

				unit
Recommended Supply Voltage	$V_{CC}$		13.2	V
Recommended Load Resistance	$R_L$	2 channels	4	$\Omega$
Operating Voltage Range	$V_{CC}$ op		10~16	V

**Operating Characteristics** at  $T_a=25^\circ\text{C}$ ,  $V_{CC}=13.2\text{V}$ ,  $R_L=4\Omega$ ,  $f=1\text{kHz}$ ,  $R_g=600\Omega$ ,with  $100 \times 100 \times 1.5\text{mm}^3$  Al heat sink

			min	typ	max	unit
Quiescent Current	$I_{cco}$			75	150	mA
Voltage Gain	VG		49.5	51.5	53.5	dB
Output Power	$P_o$	THD=10%, 2 channels	5.0	5.5		W
Total Harmonic Distortion	THD	$P_o=1\text{W}$		0.2	1.0	%
Input Resistance	$r_i$			30		k $\Omega$
Output Noise Voltage	$V_{NO}$	$R_g=0$		0.6	1.0	mV
		$R_g=10\text{k}\Omega$		1.0	2.0	mV
Ripple Rejection	SVRR	$R_g=0$ , $V_{CCR}=200\text{mV}$ , $f_r=100\text{Hz}$		46		dB
Channel Separation	CHsep	$R_g=10\text{k}\Omega$ , $V_o=0\text{dBm}$	45	55		dB

**Package Dimensions 3107**

(unit: mm)

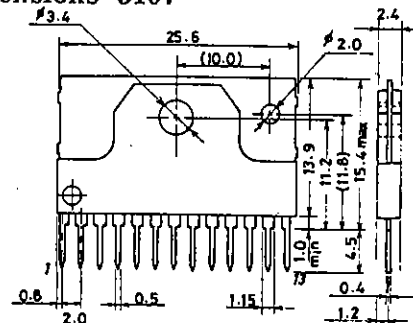

SANYO: SIP13H

**SANYO Electric Co., Ltd. Semiconductor Business Headquarters**  
 TOKYO OFFICE Tokyo Bldg., 1-10, 1 Chome, Ueno, Taito-ku, TOKYO, 110 JAPAN

N3093TS/8240TS/9177AT, TS No.2636-1/7

Equivalent Circuit Block Diagram

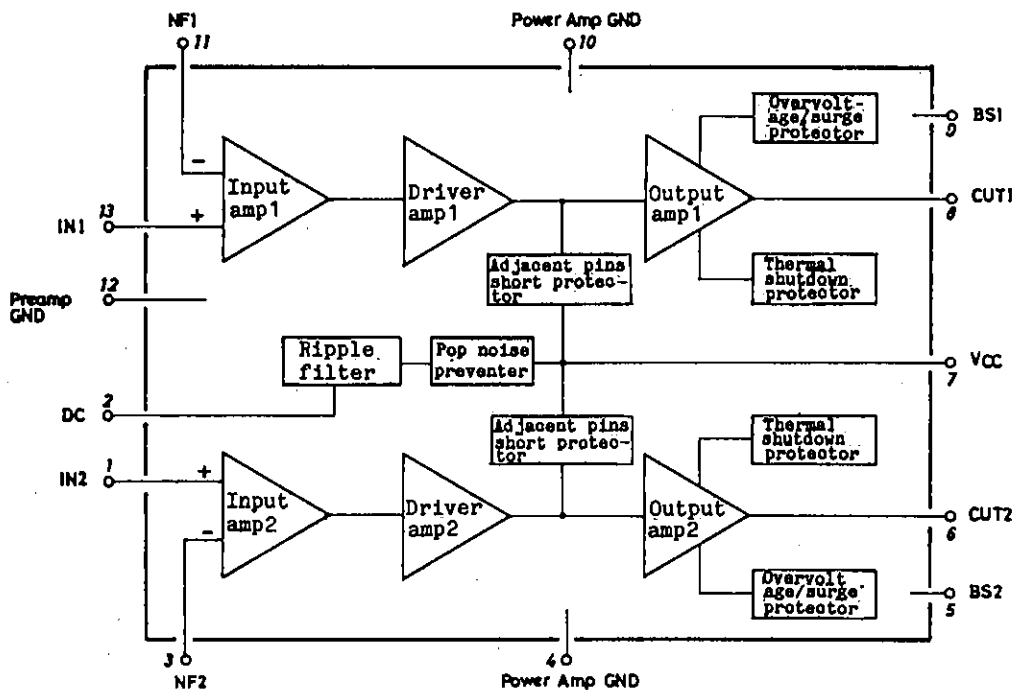

Sample Application Circuit

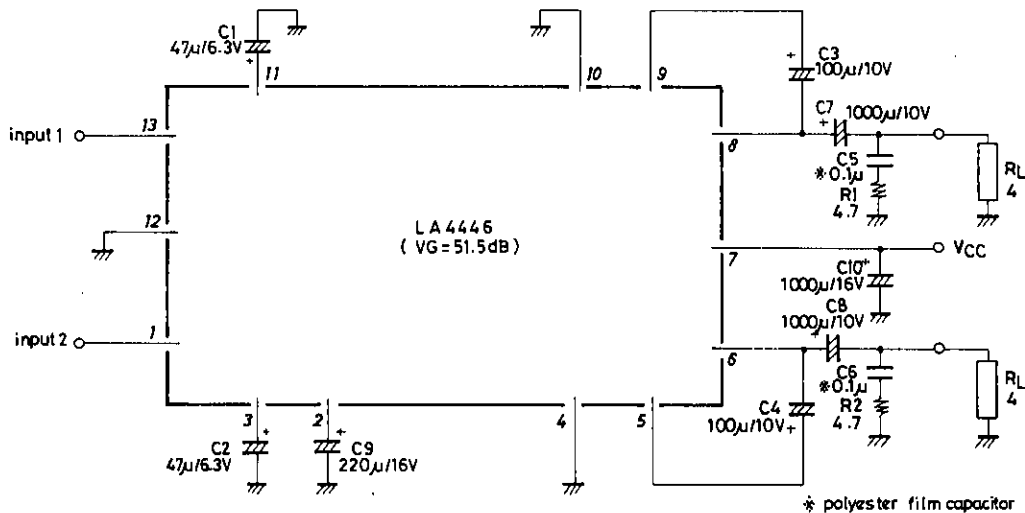

\* polyester film capacitor

Unit (resistance: Ω, capacitance: F)

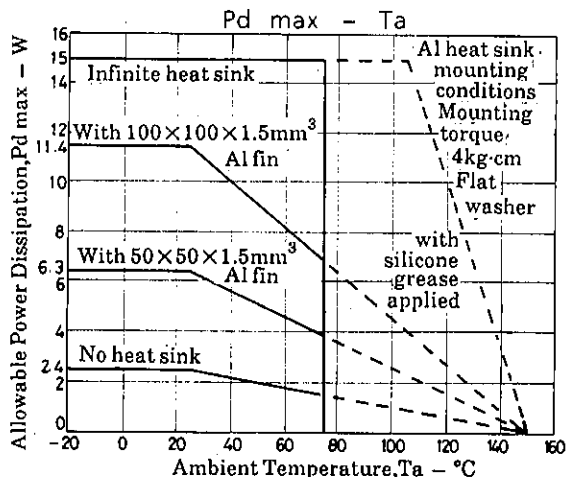

## Sample Printed Circuit Pattern (Cu-foiled area)

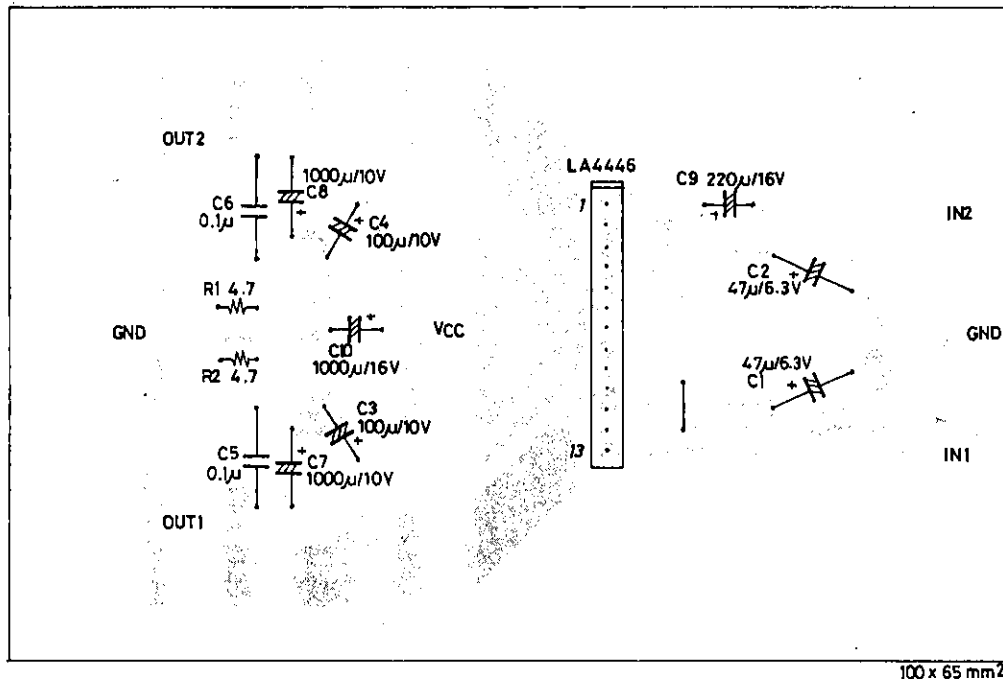
Unit (resistance:  $\Omega$ , capacitance: F)

※ Mounting the heat sink, use a flat screw. Mounting torque: 4 to kg-cm

## Features of IC System

- 2-channel use
- Decoupling capacitor C9=220uF is used to reject ripple and determine the delay time at the time of application of power.
- A low roll-off frequency depends on the NF capacitor. Refer to the graph. To extend  $f_L$ , the output capacitor must be also considered.
- To make the pop noise much less, connect  $R_{NF}$ ' to NF capacitors C1, C2 to decrease the gain.

$$VG \approx 20 \log \frac{R_f}{R_{NF}} \quad [\text{dB}]$$

$$R_{NF} \approx 50 \Omega, R_f = 20 \text{ k}\Omega \text{ on chip}$$

When  $R_{NF} = 50 \text{ ohms}$  is connected to NF capacitors C1, C2 externally, the gain becomes approximately 46dB. When  $R_{NF}' = 150 \text{ ohms}$  is connected additionally, the gain becomes approximately 40dB.

- Ripple rejection, total harmonic distortion, and oscillation depend on the layout of the printed circuit board. Large-signal GND, small-signal GND processing and parts GND points must be considered particularly.
- When providing external audio muting intentionally, the IC can be cut off by connecting decoupling pin ② to GND through limiting resistor 50 to 100ohms.
- The  $V_{CCout}$  pin adjacent to other pins with a space of 2mm pitch is liable to undergo breakdown caused by solder bridge in the manufacturing process. Therefore, pins ⑦-⑧, ⑦-⑥ DC short protectors are contained. The LA4446 is designed to operate from car-use voltage regulation 10.5 to 15.6V.
- Overvoltage/surge protector  
Used to withstand giant pulses of positive surge 50V/200msec. The test is conducted based on the JASO standard in principle. The overvoltage protector is activated at  $V_{CCX} \approx 24.5\text{V}$ .
- Thermal protector  
Used to prevent instantaneous breakdown of the IC that may be caused by improper thermal design or abnormal state such as AC load short. The thermal protector is activated at  $T_j = 160^\circ\text{C}$ .

2-Channel Characteristics

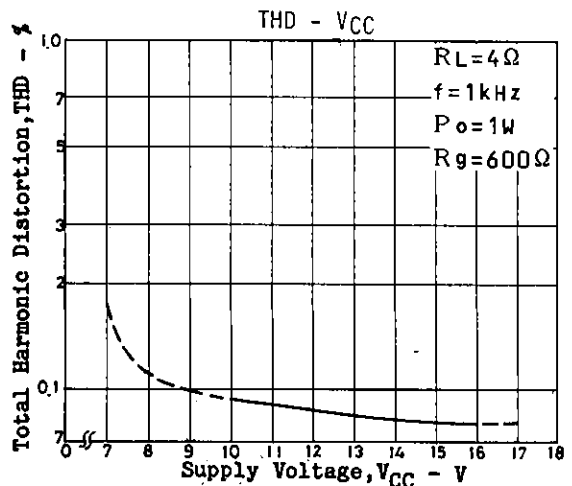
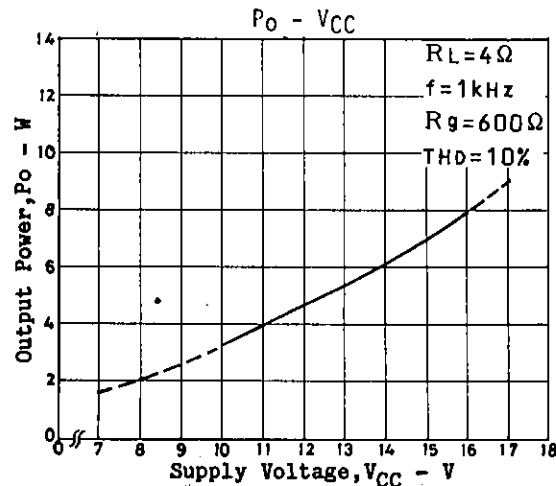
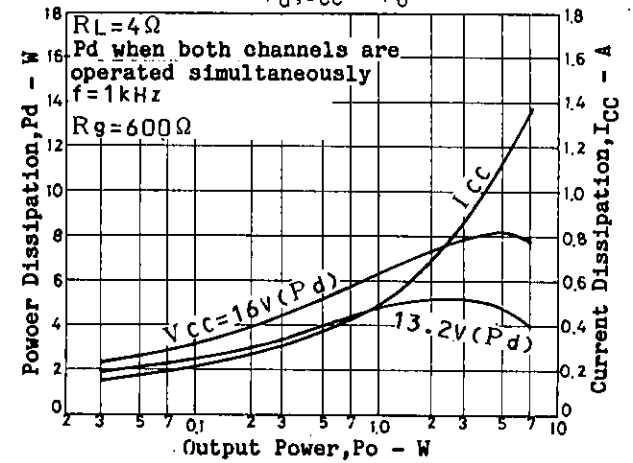
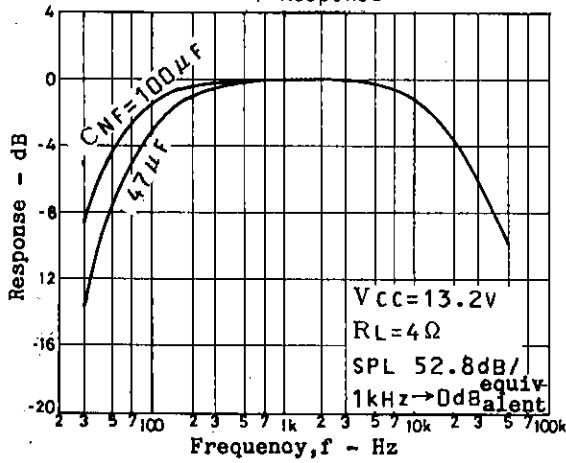
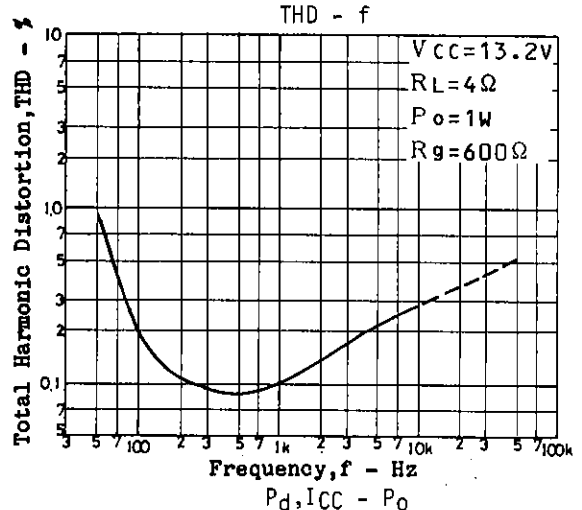
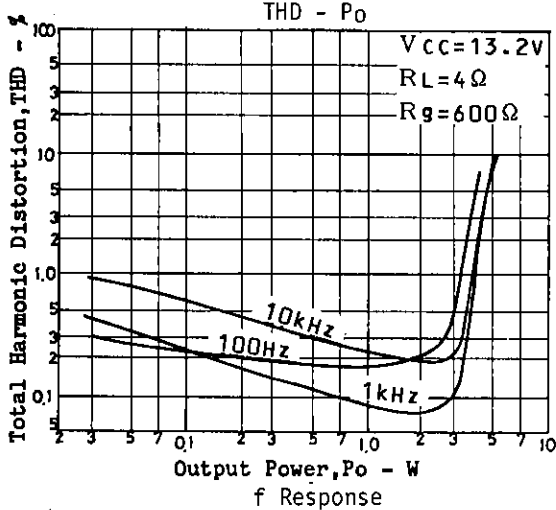
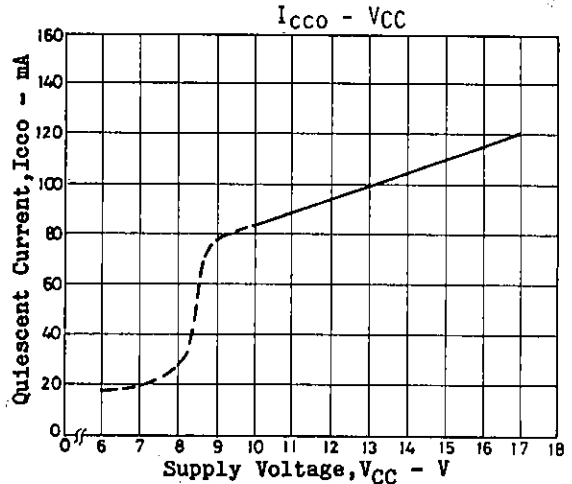
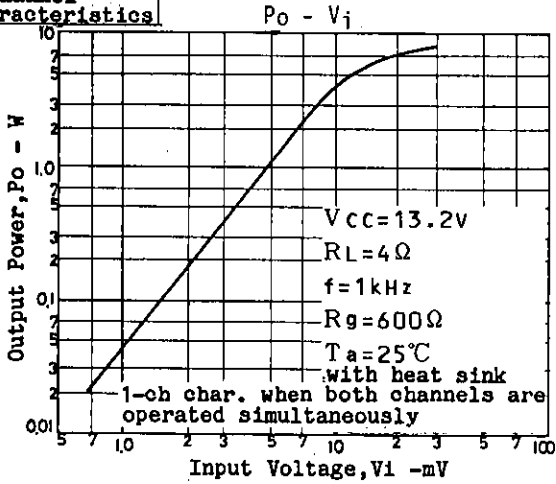

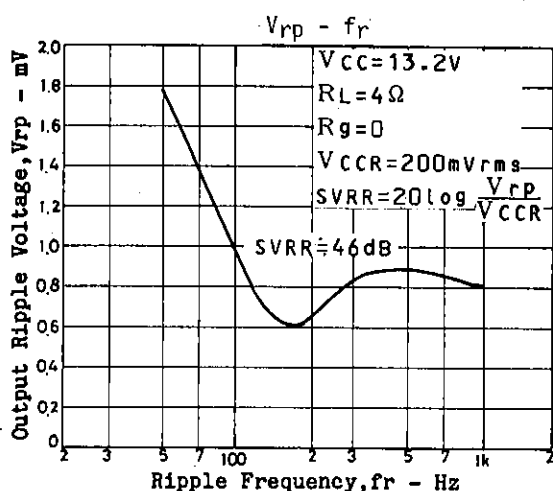
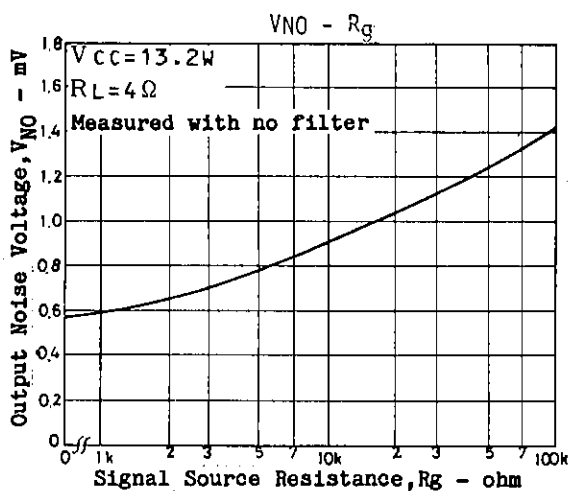

Sample BTL

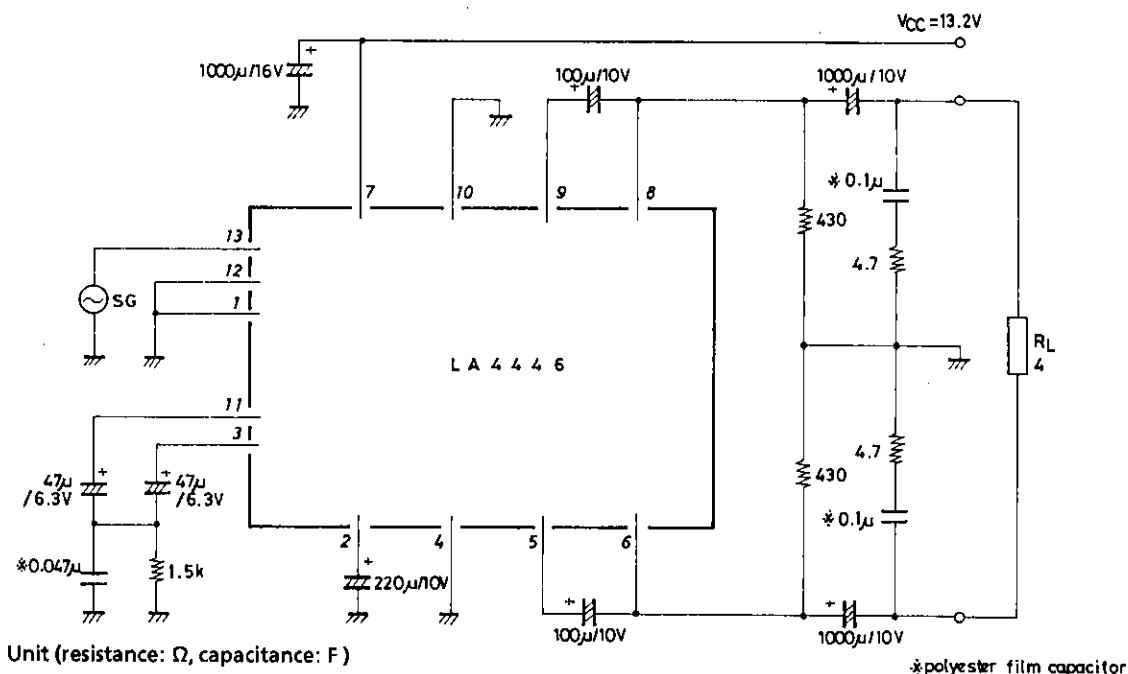

BTL Characteristics

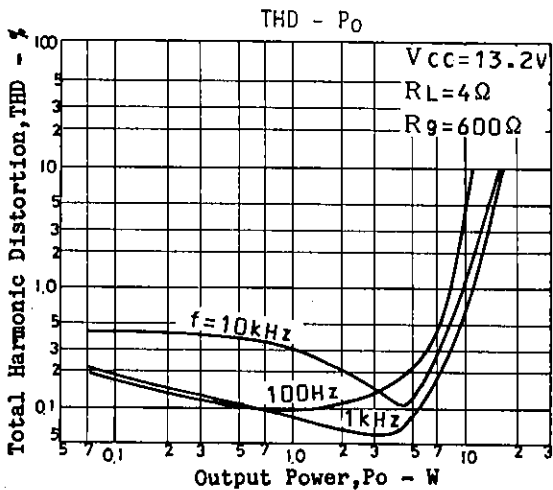
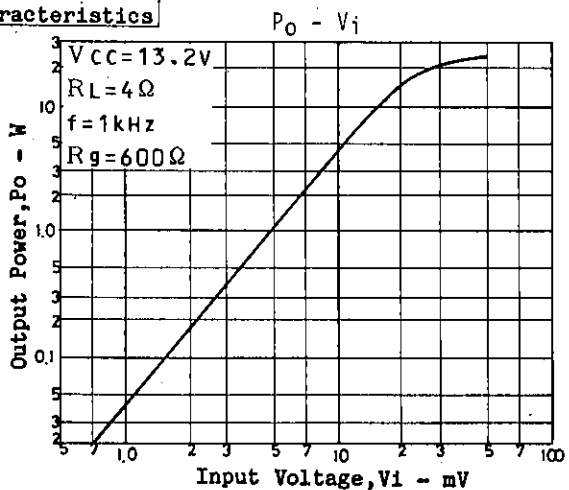

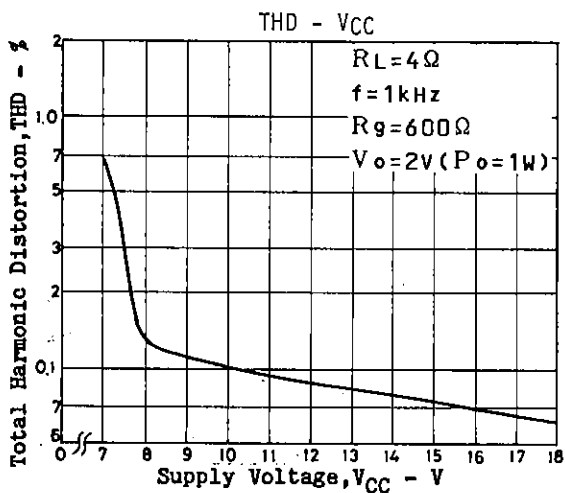
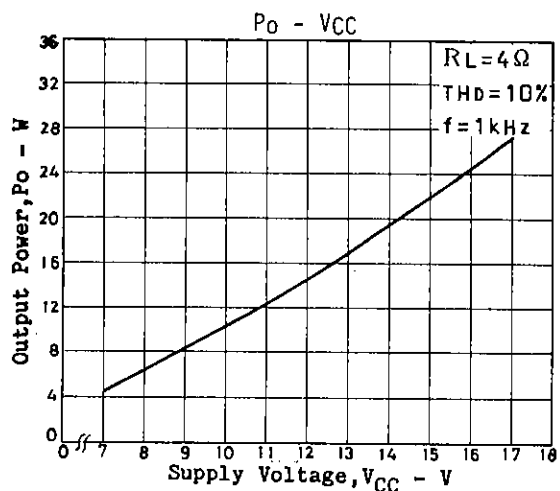
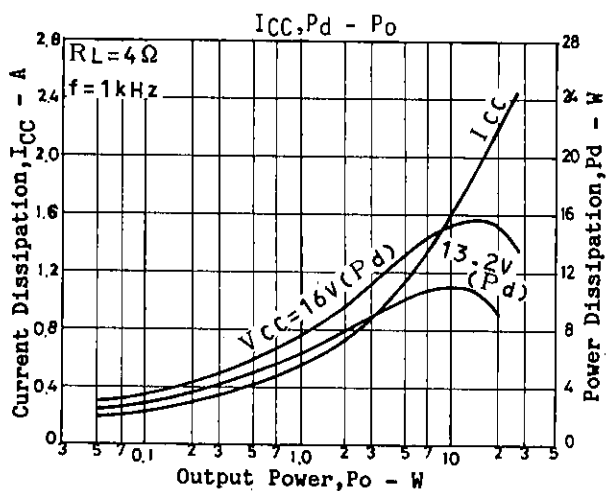
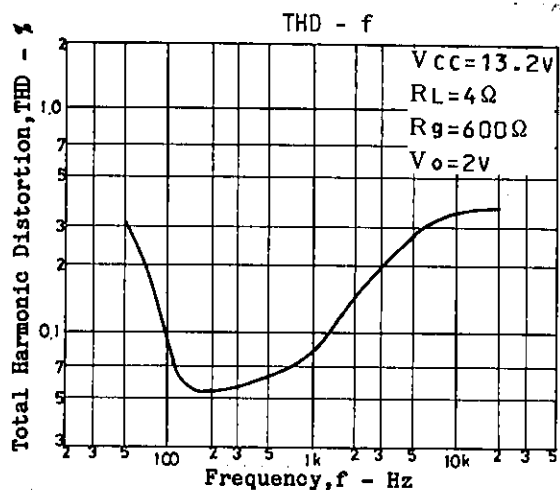
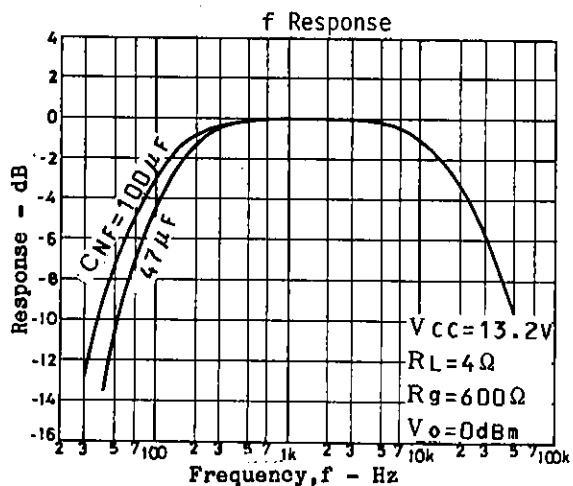

- No products described or contained herein are intended for use in surgical implants, life-support systems, aerospace equipment, nuclear power control systems, vehicles, disaster/crime-prevention equipment and the like, the failure of which may directly or indirectly cause injury, death or property loss.
- Anyone purchasing any products described or contained herein for an above-mentioned use shall:
  - ① Accept full responsibility and indemnify and defend SANYO ELECTRIC CO., LTD., its affiliates, subsidiaries and distributors and all their officers and employees, jointly and severally, against any and all claims and litigation and all damages, cost and expenses associated with such use;
  - ② Not impose any responsibility for any fault or negligence which may be cited in any such claim or litigation on SANYO ELECTRIC CO., LTD., its affiliates, subsidiaries and distributors or any of their officers and employees jointly or severally.
- Information (including circuit diagrams and circuit parameters) herein is for example only; it is not guaranteed for volume production. SANYO believes information herein is accurate and reliable, but no guarantees are made or implied regarding its use or any infringements of intellectual property rights or other rights of third parties.