

**SANYO**

No.3802A

**Single-chip PLL and Microcontroller  
with LCD Driver****OVERVIEW**

The LC7233 is a single-chip microcontroller that incorporates a phase-locked loop (PLL), which can operate up to 150 MHz, and a liquid-crystal display (LCD) driver, making it ideal for digital tuners. It has a large number of input/output ports and a frequency measurement circuit.

The LC7233 features on-chip RAM and ROM, a programmable high-speed divider, a 6-bit analog-to-digital converter and a low-voltage detection reset circuit.

The LC7233 operates from a single 5 V supply and is available in 64-pin QIPs.

**FEATURES**

- 150 MHz phase-locked loop
- LCD driver
- 6-bit analog-to-digital converter
- Two 8-bit PWM digital-to-analog converters
- Two 4-bit input ports
- Two 4-bit input/output ports
- 6-bit keypad matrix scan output
- 2-bit open-drain high-voltage output
- 23 mask-selectable output drivers
- 20-bit universal counter
- 4096 × 16-bit program ROM (000H to FFEH user-addressable memory)
- 256 × 4-bit data RAM
- Low-voltage detection reset circuit
- Programmable high-speed divider
- Single-word instructions
- Four-level stack
- PLL-unlocked flip-flop
- Timer flip-flop
- Programmable watchdog interrupt address
- Standby mode
- CPU operates down to 3.5 V, with data retention down to 1.3 V.
- Single 5 V supply
- 64-pin QIP

**PINOUT**

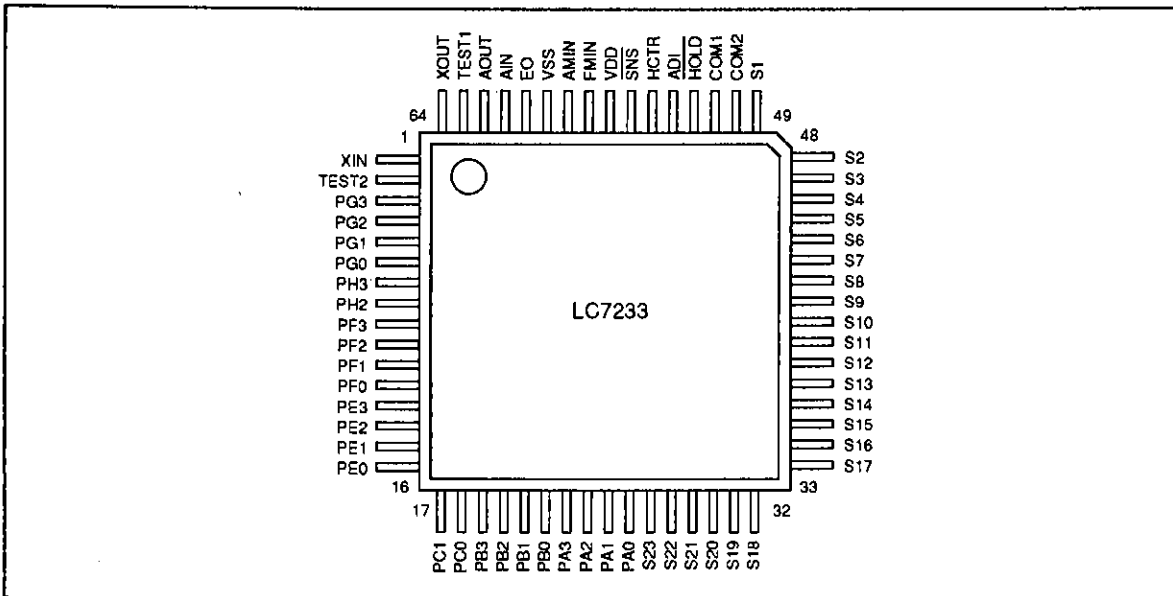

**PACKAGE DIMENSIONS**

Unit: mm

3159-QIP64E

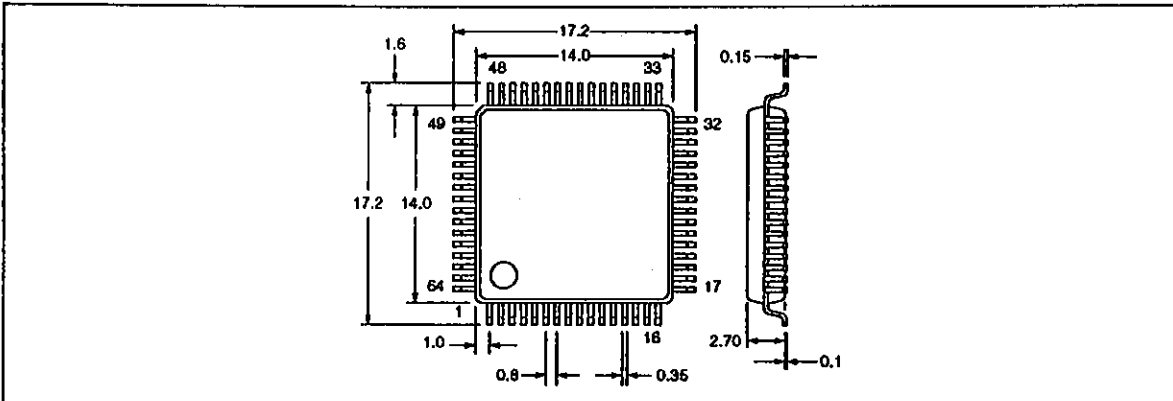

- No products described or contained herein are intended for use in surgical implants, life-support systems, aerospace equipment, nuclear power control systems, vehicles, disaster/crime-prevention equipment and the like, the failure of which may directly or indirectly cause injury, death or property loss.
- Anyone purchasing any products described or contained herein for an above-mentioned use shall:
  - ① Accept full responsibility and indemnify and defend SANYO ELECTRIC CO., LTD., its affiliates, subsidiaries and distributors and all their officers and employees, jointly and severally, against any and all claims and litigation and all damages, cost and expenses associated with such use:
  - ② Not impose any responsibility for any fault or negligence which may be cited in any such claim or litigation on SANYO ELECTRIC CO., LTD., its affiliates, subsidiaries and distributors or any of their officers and employees jointly or severally.
- Information (including circuit diagrams and circuit parameters) herein is for example only; it is not guaranteed for volume production. SANYO believes information herein is accurate and reliable, but no guarantees are made or implied regarding its use or any infringements of intellectual property rights or other rights of third parties.

BLOCK DIAGRAM

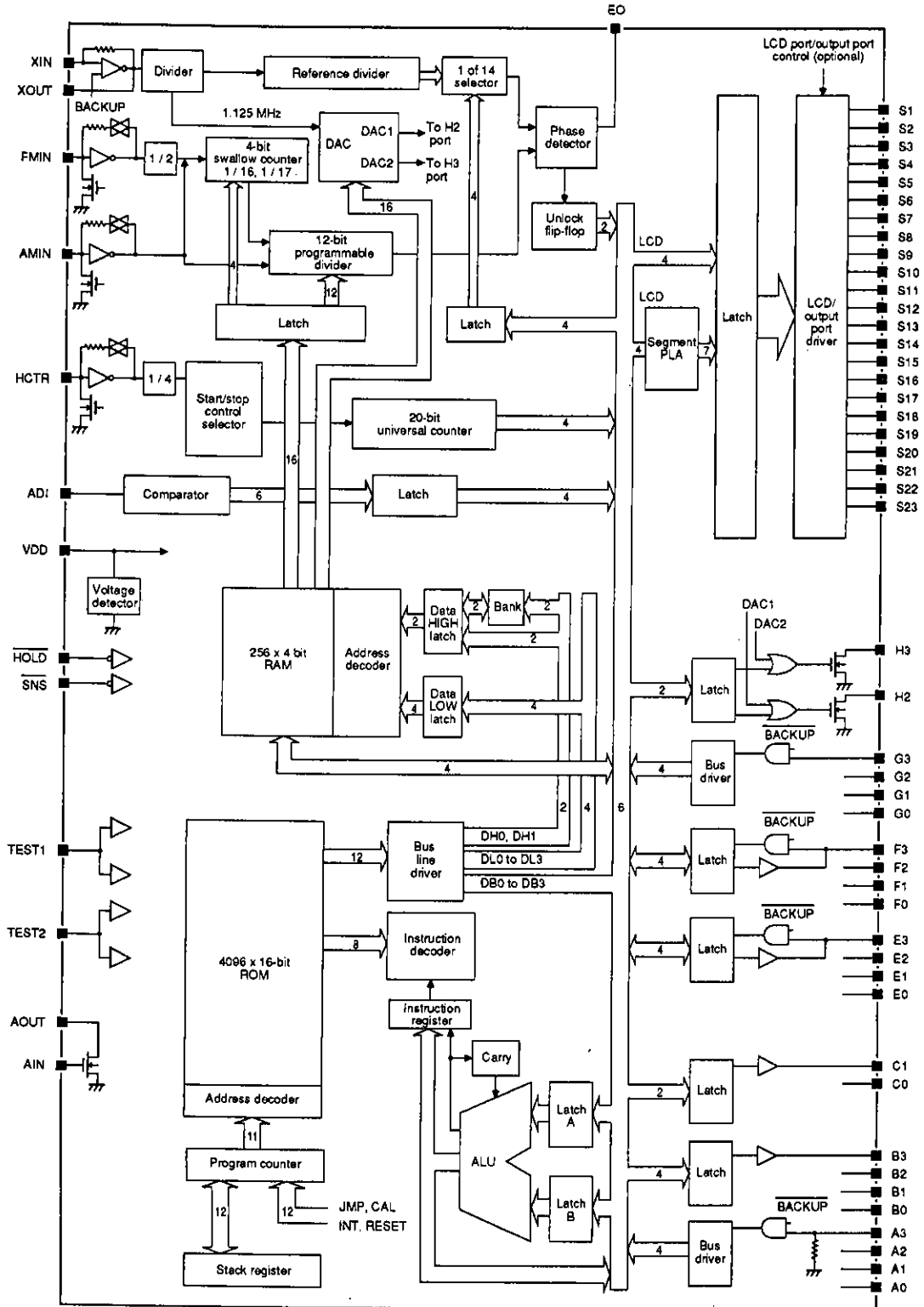

**PIN DESCRIPTION**

Number	Name	Equivalent circuit	Description
1	XIN		Crystal oscillator connections
64	XOUT		
2	TEST2		Test pins
63	TEST1		
3 to 6	PG3 to PG0		Input port G
7, 8	PH1, PH0		Output port H
9 to 12	PF3 to PF0		Input/output port F
13 to 16	PE3 to PE0		Input/output port E
17, 18	PC1, PC0		Output port C
19 to 22	PB3 to PB0		Output port B
23 to 26	PA3 to PA0		Input port A

LC7233

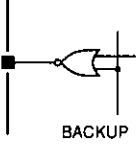
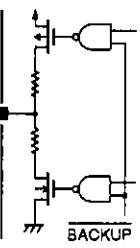
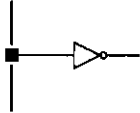
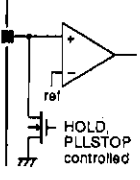
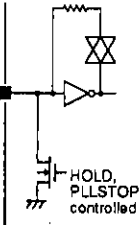
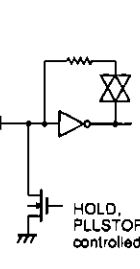
Number	Name	Equivalent circuit	Description
27 to 49	S23 to S1	 <p>BACKUP</p>	LCD segment outputs
50, 51	COM2, COM1	 <p>BACKUP</p>	LCD common driver outputs
52	$\overline{\text{HOLD}}$		Hold-mode control input
55	$\overline{\text{SNS}}$		Power-fail detect
53	ADI	 <p>ref HOLD, PLLSTOP controlled</p>	A/D converter input
54	HCTR	 <p>HOLD, PLLSTOP controlled</p>	Universal counter input
56	VDD		5 V supply
57	FMIN	 <p>HOLD, PLLSTOP controlled</p>	FM VCO input
58	AMIN		AM VCO input
59	VSS		Ground

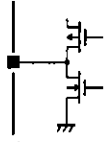
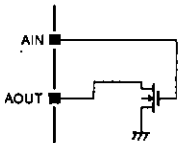
Number	Name	Equivalent circuit	Description
60	E0		Phase comparator output
61	A1N		Analog input
62	A1OUT		Analog output

## SPECIFICATIONS

### Absolute Maximum Ratings

Parameter	Symbol	Rating	Unit
Supply voltage range	$V_{DD\ max}$	-0.3 to 6.5	V
Port G, HOLD, ADI and SNS input voltage range	$V_{IN1}$	-0.3 to 13	V
Input voltage range (other inputs)	$V_{IN2}$	-0.3 to $V_{DD} + 0.3$	V
Port H and AOUT output voltage range	$V_{OUT1}$	-0.3 to 15	V
Output voltage range (all other outputs)	$V_{OUT2}$	-0.3 to $V_{DD} + 0.3$	V
Port H output current range	$I_{OUT1}$	0 to 5	mA
Ports E and F output current range	$I_{OUT2}$	0 to 3	mA
Ports B and C output current range	$I_{OUT3}$	0 to 1	mA
AOUT output current range	$I_{OUT4}$	0 to 2	mA
Power dissipation	$P_D$	400	mW
Operating temperature range	$T_{opr}$	-40 to 85	deg. C
Storage temperature range	$T_{stg}$	-45 to 125	deg. C

### Recommended Operating Conditions

$T_a = 25\ deg.\ C$

Parameter	Symbol	Rating	Unit
Supply voltage	$V_{DD}$	5	V
Supply voltage range (PLL and CPU)	$V_{DD1}$	4.5 to 5.5	V
Supply voltage range (CPU)	$V_{DD2}$	3.5 to 5.5	V
Supply voltage range for data retention	$V_{DD3}$	1.3 to 5.5	V

## Electrical Characteristics

 $V_{DD} = 3.5$  to  $5.5$  V,  $T_a = -40$  to  $85$  deg. C unless otherwise noted

Parameter	Symbol	Condition	Rating			Unit
			min	typ	max	
Port G HIGH-level input voltage	$V_{IH1}$		$0.7V_{DD}$	–	8.0	V
$\overline{SNS}$ HIGH-level input voltage	$V_{IH2}$		2.5	–	8.0	V
Port A HIGH-level input voltage	$V_{IH3}$		$0.6V_{DD}$	–	$V_{DD}$	V
Ports E and F HIGH-level input voltage	$V_{IH4}$		$0.7V_{DD}$	–	$V_{DD}$	V
$\overline{HOLD}$ HIGH-level input voltage	$V_{IH5}$		$0.8V_{DD}$	–	8.0	V
Port G LOW-level input voltage	$V_{IL1}$		0	–	$0.3V_{DD}$	V
$\overline{HOLD}$ LOW-level input voltage	$V_{IL2}$		0	–	$0.4V_{DD}$	V
$\overline{SNS}$ LOW-level input voltage	$V_{IL3}$		0	–	1.3	V
Port A LOW-level input voltage	$V_{IL4}$		0	–	$0.2V_{DD}$	V
Ports E and F LOW-level input voltage	$V_{IL5}$		0	–	$0.3V_{DD}$	V
XIN input frequency	$f_{IN1}$	$V_{IN} = 0.5$ to $1.5$ V	4.0	4.5	5.0	MHz
FMIN input frequency	$f_{IN2}$	$V_{IN} = 0.1$ to $1.5$ V, $V_{DD} = 4.5$ to $5.5$ V	10	–	130	MHz
		$V_{IN} = 0.15$ to $1.5$ V, $V_{DD} = 4.5$ to $5.5$ V	10	–	150	
AMIN input frequency (low range)	$f_{IN3}$	$V_{IN} = 0.1$ to $1.5$ V, $V_{DD} = 4.5$ to $5.5$ V	0.5	–	10	MHz
AMIN input frequency (high range)	$f_{IN4}$	$V_{IN} = 0.1$ to $1.5$ V, $V_{DD} = 4.5$ to $5.5$ V	2.0	–	40	MHz
HCTR input frequency	$f_{IN5}$	$V_{IN} = 0.1$ to $1.5$ V, $V_{DD} = 4.5$ to $5.5$ V	0.4	–	12	MHz
XIN rms input amplitude	$V_{IN1}$		0.5	–	1.5	V
FMIN rms input amplitude	$V_{IN2}$		0.1	–	1.5	V
AMIN rms input amplitude	$V_{IN3}$		0.1	–	1.5	V
HCTR rms input amplitude	$V_{IN4}$		0.1	–	1.5	V
ADI input voltage range	$V_{IN5}$		0	–	$V_{DD}$	V
$\overline{SNS}$ reject pulsewidth	$P_{rej}$		–	–	50	$\mu s$
Standby threshold voltage	$V_{DET}$		2.7	3.0	3.3	V
$\overline{HOLD}$ , ADI, $\overline{SNS}$ and port G HIGH-level input current	$I_{IH1}$	$V_{IN} = 5.5$ V	–	–	3.0	$\mu A$
Ports A, E and F HIGH-level input current	$I_{IH2}$	Ports E and F are high impedance, port A has no $R_{PD}$ , $V_{IN} = V_{DD}$	–	–	3.0	$\mu A$
XIN HIGH-level input current	$I_{IH3}$	$V_{IN} = V_{DD} = 5.0$ V	2	5	15	$\mu A$
FMIN, AMIN and HCTR HIGH-level input current	$I_{IH4}$	$V_{IN} = V_{DD} = 5.0$ V	4	10	30	$\mu A$
Port A HIGH-level input current	$I_{IH5}$	$V_{IN} = V_{DD} = 5.0$ V, port A has $R_{PD}$	–	50	–	$\mu A$
AIN HIGH-level input current	$I_{IH6}$	$V_{IN} = V_{DD}$	–	0.01	10.00	nA

LC7233

Parameter	Symbol	Condition	Rating			Unit
			min	typ	max	
HOLD, ADI, SNS and port G LOW-level input current	$I_{IL1}$	$V_{IN} = V_{SS}$	-	-	3.0	$\mu A$
Ports A, E and F LOW-level input current	$I_{IL2}$	Ports E and F are high impedance, port A has no $R_{PD}$ , $V_{IN} = V_{SS}$	-	-	3.0	$\mu A$
XIN LOW-level input current	$I_{IL3}$	$V_{IN} = V_{SS}$	2	5	15	$\mu A$
FMIN, AMIN and HCTR LOW-level input current	$I_{IL4}$	$V_{IN} = V_{SS}$	4	10	30	$\mu A$
AIN LOW-level input current	$I_{IL5}$	$V_{IN} = V_{SS}$	-	0.01	10.0	nA
Port A input voltage	$V_{IF}$	Port A is high impedance	-	-	$0.05V_{DD}$	V
Port A pull-down resistance	$R_{PD}$	$V_{DD} = 5 V$	75	100	200	$k\Omega$
EO output leakage current	$I_{OFFH1}$	$V_O = V_{DD}$	-	0.01	10.0	nA
Ports B, C, E and F output leakage current	$I_{OFFH2}$	$V_O = V_{DD}$	-	-	3.0	$\mu A$
Port H output leakage current	$I_{OFFH3}$	$V_O = 13 V$	-	-	5.0	$\mu A$
AOUT output leakage current	$I_{OFFH4}$	$V_O = 13 V$	-	-	1.0	$\mu A$
EO output leakage current	$I_{OFFL1}$	$V_O = V_{SS}$	-	0.01	10.0	nA
Ports B, C, E and F output leakage current	$I_{OFFL2}$	$V_O = V_{SS}$	-	-	3.0	$\mu A$
Ports B and C HIGH-level output voltage	$V_{OH1}$	$I_O = 1 mA$	$V_{DD} - 2.0$	$V_{DD} - 1.0$	$V_{DD} - 0.5$	V
Ports E and F HIGH-level output voltage	$V_{OH2}$	$I_O = 1 mA$	$V_{DD} - 1.0$	-	-	V
EO HIGH-level output voltage	$V_{OH3}$	$I_O = 500 \mu A$	$V_{DD} - 1.0$	-	-	V
XOUT HIGH-level output voltage	$V_{OH4}$	$I_O = 200 \mu A$	$V_{DD} - 1.0$	-	-	V
S1 to S23 HIGH-level output voltage	$V_{OH5}$	$I_O = -0.1 mA$	$V_{DD} - 1.0$	-	-	V
COM1 and COM2 HIGH-level output voltage	$V_{OH6}$	$I_O = 25 \mu A$	$V_{DD} - 0.75$	-	-	V
Ports B and C LOW-level output voltage	$V_{OL1}$	$I_O = 50 \mu A$	0.5	1.0	2.0	V
Ports E and F LOW-level output voltage	$V_{OL2}$	$I_O = 1 mA$	-	-	1.0	V
EO LOW-level output voltage	$V_{OL3}$	$I_O = 500 \mu A$	-	-	1.0	V
XOUT LOW-level output voltage	$V_{OL4}$	$I_O = 200 \mu A$	-	-	1.0	V
S1 to S23 LOW-level output voltage	$V_{OL5}$	$I_O = 0.1 mA$	-	-	1.0	V
AOUT LOW-level output voltage	$V_{OL6}$	$I_O = 5 mA$ , $I_{AIN} = 1.3 V$	-	-	0.5	V
COM1 and COM2 LOW-level output voltage	$V_{OL7}$	$I_O = 25 \mu A$	0.3	0.5	0.75	V
Port H LOW-level output voltage	$V_{OL8}$	$I_O = 5 mA$	0.75	-	2.0	V
COM1 and COM2 mid-level output voltage	$V_{M1}$	$V_{DD} = 5 V$ , $I_O = 20 \mu A$	2.0	2.5	3.0	V



## LC7233

Parameter	Symbol	Condition	Rating			Unit
			min	typ	max	
A/D converter error	$\epsilon$	$V_{DD} = 4.5$ to $5.5$ V	$-\frac{1}{2}$	–	$\frac{1}{2}$	lsb
Supply current	$I_{DD1}$	$f_{in} = 130$ MHz, $V_{DD} = 4.5$ to $5.5$ V	–	15	20	mA
Hold-mode supply current	$I_{DD2}$	PLL halted, $t_{cyc} = 2.67$ $\mu$ s	–	1.5	–	mA
		PLL halted, $t_{cyc} = 13.33$ $\mu$ s, $V_{DD} = 3.5$ to $5.5$ V	–	1.0	–	
		PLL halted, $t_{cyc} = 40.00$ $\mu$ s, $V_{DD} = 3.5$ to $5.5$ V	–	0.7	–	
Standby-mode supply current	$I_{DD3}$	$V_{DD} = 5.5$ V, oscillator halted, $T_a = 25$ deg. C	–	–	5	$\mu$ A
		$V_{DD} = 2.5$ V, oscillator halted, $T_a = 25$ deg. C	–	–	1	

### Measurement Circuits

#### Hold mode

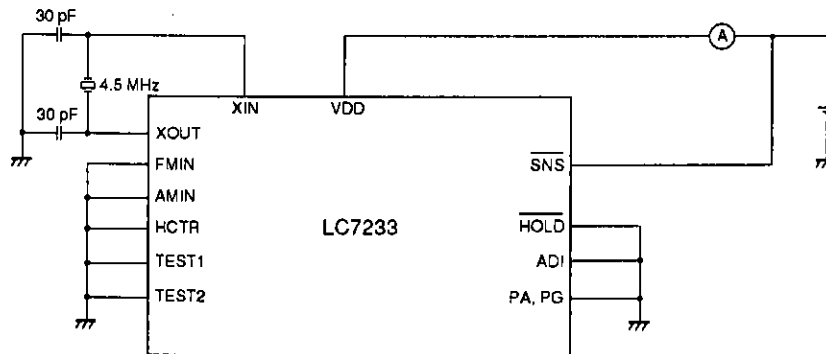

#### Notes

1. Ports E and F are selected as output ports.
2. Ports A to H, S1 to S23, COM1 and COM2 are open.

#### Standby mode

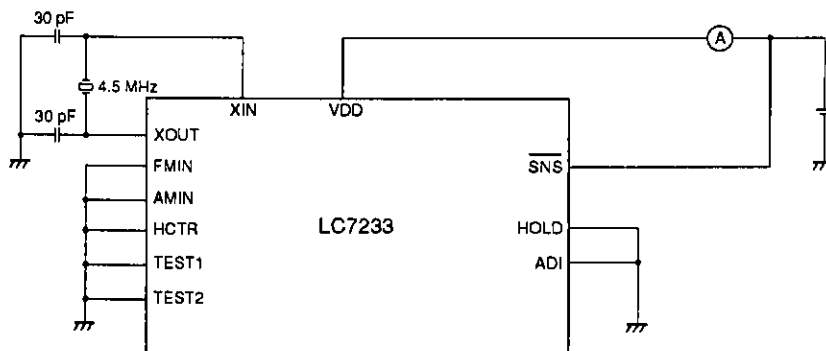

#### Note

Ports A to H, S1 to S23, COM1 and COM2 are open.

## FUNCTIONAL DESCRIPTION

### LCD Driver

The LC7233 can drive LCD segments. The LCP and LCD instructions transfer data to the LCD outputs. The LCD instruction transfers data directly to the LCD outputs. The LCP instruction converts data to 7-segment format before transfer to the outputs.

S1 to S23 are the driver outputs. The LCD frame rate is 100 Hz with a 50% duty cycle. After reset or power-up, a blank signal is present on all outputs. In standby mode, all outputs are LOW. They can be used as general-purpose outputs if the appropriate mask option is selected.

COM1 and COM2 are the LCD common driver outputs. Output drive is 50% duty with 50% bias. Upon reset or after power-up, the normal drive signals are present on these outputs. In standby mode, all outputs are LOW.

### Frequency Counter

Frequency measurement is performed at the HCTR input by the 20-bit universal counter. The input frequency range is 0.4 to 12 MHz, which is used for measuring AM and FM IF frequencies. Capacitive coupling should be used.

### Phase-locked Loop

The FMIN or AMIN input signal is divided down by a programmable divider, and then compared with the crystal frequency, which is also divided down using 14 selectable ratios. The phase difference between the two signals is measured using a phase detector and output on EO.

FMIN is the input pin for the FM VCO input signal. The input frequency range is 10 to 130 MHz. Capacitive coupling should be used.

AMIN is the AM VCO input. The bandwidth is adjustable in two ranges by using the PLL instruction—HIGH (2 to 40 MHz) for the SW band, and LOW (0.5 to 10 MHz), for the LW and MW bands. Capacitive coupling should be used.

### Input/Output Ports

#### Port A

This input port has a low switching threshold, which is used for keypad matrix inputs. Pull-down resistors for all pins are available as a mask option. Note that either all or none of the pins should have pull-down resistors. In standby mode, inputs are ignored.

#### Ports B and C

These output ports have unbalanced CMOS outputs which are used as keypad matrix scan outputs. Upon reset, outputs are set LOW, and in standby mode, outputs are high impedance. The outputs can be short-circuited.

#### Port E

The transfer direction of this input/output port is selected automatically under software control. When an input instruction (IN, TPT, or TPF) is executed, port E is configured for input operation, and an output instruction (OUT, SPB or RPB), for output operation. Upon reset, all pins become inputs. In standby mode, the output drivers are high impedance and the input signals are ignored. All bits should either be inputs or outputs.

#### Port F

The transfer direction of this input/output port is selected by the FPC instruction. Each pin of this port can be set independently to be an input or output. Upon reset, all pins become inputs. In standby mode, the output drivers are high impedance and the input signals are ignored.

**Port G**

This is an input port only. In standby mode, inputs are ignored.

**Port H**

These output ports are high-voltage, n-channel open-drain drivers, which are used for switching power supplies. Upon reset and in standby mode, outputs are high impedance. Port H can also be configured as the output of DAC1 and DAC2.

**A/D Converter**

The A/D converter is a 6-bit successive approximation type. The conversion cycle time is 1.28 ms. Full-scale output data is 3FH for an input of  $V_{DD} \times (63/96)$ .

**Power-fall Detection**

When connected to the supply,  $\overline{SNS}$  is used as a power-fail detector.  $\overline{SNS}$  can also be used as a standard input port.

**Crystal Oscillator**

The master crystal oscillator, which has a feedback resistor on-chip, requires only the connection of a 4.5 MHz crystal.

**Low-power Modes****Hold mode**

When the hold-mode control pin,  $\overline{HOLD}$ , is driven LOW and the HOLDEN (hold enable) flip-flop has previously been set by an SS instruction, the LC7233 enters hold mode.

$\overline{HOLD}$  has a high-voltage input ( $V_{IH(max)} = 8.0$  V) which can be connected directly to the power supply.

**Standby mode**

When the LC7233 is in hold mode and  $\overline{HOLD}$  is LOW, standby mode can be set by the CKSTP instruction.

**Test Pins**

Two device test pins are provided—TEST1 and TEST2. These should either be tied to  $V_{SS}$  or left open.

**INSTRUCTION SET**

ADDR	Program memory address [12 bits]
b	Borrow
B	Bank number [2 bits]
C	Carry
DH	Data memory address high-order bits (row address) [2 bits]
DL	Data memory address low-order bits (column address) [4 bits]
I	Immediate data [4 bits]
M	Data memory address
N	Bit position [4 bits]
Pn	Port number [4 bits]
r	General register (Bank 00H to 0FH)
Rn	Register number [4 bits]
( )	Contents of register or memory
( )n	Contents of bit N of register or memory

Mnemonic	Operand		Operation	Instruction format																Description	Skip condition		
	1st	2nd		D15	D14	D13	D12	D11	D10	D9	D8	D7	D6	D5	D4	D3	D2	D1	D0				
																						Add instructions	
AD	r	M	Add M to r	0	1	0	0	0	0	0	0	0	0	0	0	0	0	Rn	DL	DH	Rn	$r \leftarrow (r) + (M)$ Adds the contents of M to the contents of r and stores the result in r	
ADS	r	M	Add M to r and skip if carry	0	1	0	0	0	1	0	0	0	0	0	0	0	0	Rn	DL	DH	Rn	$r \leftarrow (r) + (M)$ , skip if carry Adds the contents of M to the contents of r and stores the result in r. Skips if a carry is generated	Carry
AC	r	M	Add M to r with carry	0	1	0	0	0	1	0	0	0	0	0	0	0	0	Rn	DL	DH	Rn	$r \leftarrow (r) + (M) + C$ Adds the contents of M to the contents of r and stores the result in r	
ACS	r	M	Add M to r with carry and skip if carry	0	1	0	0	0	1	1	0	0	0	0	0	0	0	Rn	DL	DH	Rn	$r \leftarrow (r) + (M) + C$ , skip if carry Adds the content of M to the contents of r and stores the result in r. Skips if a carry is generated	Carry
AI	M	I	Add I to M	0	1	0	1	0	0	0	0	0	0	0	0	0	I	DL	DH	I	$M \leftarrow (M) + I$ Adds the immediate data to the contents of M and stores the result in M		
AIS	M	I	Add I to M and skip if carry	0	1	0	1	0	1	0	0	0	0	0	0	0	I	DL	DH	I	$M \leftarrow (M) + I$ , skip if carry Adds the immediate data to the contents of M and stores the result in M. Skips if a carry is generated	Carry	
AIC	M	I	Add I to M with carry	0	1	0	1	0	1	0	0	0	0	0	0	0	I	DL	DH	I	$M \leftarrow (M) + I + C$ Adds the immediate data to the contents of M and stores the result in M		
AICS	M	I	Add I to M with carry and skip if carry	0	1	0	1	0	1	1	0	0	0	0	0	0	I	DL	DH	I	$M \leftarrow (M) + I + C$ , skip if carry Adds the immediate data to the contents of M and stores the result in M. Skips if a carry is generated	Carry	
Subtract instructions																							
SU	r	M	Subtract M from r	0	1	1	0	0	0	0	0	0	0	0	0	0	Rn	DL	DH	Rn	$r \leftarrow (r) - (M)$ skip if carry Subtracts the contents of M from the contents of r and stores the result in r		
SUS	r	M	Subtract M from r and skip if borrow	0	1	1	0	0	1	0	0	0	0	0	0	0	Rn	DL	DH	Rn	$r \leftarrow (r) - (M)$ , skip if borrow Subtracts the contents of M from the contents of r and stores the result in r. Skips if a borrow is generated	Borrow	
SB	r	M	Subtract M from r with borrow	0	1	1	0	0	1	0	0	0	0	0	0	0	Rn	DL	DH	Rn	$r \leftarrow (r) - (M) - b$ Subtracts the contents of M from the contents of r with borrow and stores the result in r		
SBS	r	M	Subtract M from r with borrow and skip if borrow	0	1	1	0	0	1	1	0	0	0	0	0	0	Rn	DL	DH	Rn	$r \leftarrow (r) - (M) - b$ , skip if borrow Subtracts the contents of M from the contents of r with borrow and stores the result in r. Skips if a borrow is generated	Borrow	
SI	M	I	Subtract I from M	0	1	1	1	0	0	0	0	0	0	0	0	I	DL	DH	I	$M \leftarrow (M) - I$ Subtracts the immediate data from the contents of M and stores the result in M			
SIS	M	I	Subtract I from M and skip if borrow	0	1	1	1	0	1	0	0	0	0	0	0	I	DL	DH	I	$M \leftarrow (M) - I$ , skip if borrow Subtracts the immediate data from the contents of M and stores the result in M. Skips if a borrow is generated	Borrow		
SIB	M	I	Subtract I from M with borrow	0	1	1	1	0	1	1	0	0	0	0	0	I	DL	DH	I	$M \leftarrow (M) - I - b$ Subtracts the immediate data from the contents of M with borrow and stores the result in M			

Mnemonic	Operand		Operation	Instruction format																Notation	Description	Skip condition
	1st	2nd		D15	D14	D13	D12	D11	D10	D9	D8	D7	D6	D5	D4	D3	D2	D1	D0			
	M	I		0	1	1	1	1	1	1	DH	DL										
SIBS	M	I	Subtract I from M with borrow and skip if borrow	0	1	1	1	1	1	DH	DL								$M \leftarrow (M) - I - b$ , skip if borrow	Borrow		
Compare instructions																						
SEQ	r	M	Skip if r equals M	0	0	0	0	0	1	DH	DL						Rn	$(r) - (M)$ , skip if zero	$(r) = (M)$			
SGE	r	M	Skip if r is greater than or equal to M	0	0	0	0	1	1	DH	DL						Rn	$(r) - (M)$ , skip if $(r) \geq (M)$	$(r) \geq (M)$			
SEOI	M	I	Skip if M equals I	0	0	1	1	0	1	DH	DL						I	$(M) - I$ , skip if zero	$(M) - I = 0$			
SGEI	M	I	Skip if M is greater than or equal to I	0	0	1	1	1	1	DH	DL						I	$(M) - I$ , skip if $(M) \geq I$	$(M) \geq I$			
Logic arithmetic instructions																						
AND	M	I	AND I with M	0	0	1	1	0	0	DH	DL						I	$M \leftarrow (M) \cdot I$	Calculates the logic-AND of the immediate data and the contents of M and stores the result in M			
OR	M	I	OR I with M	0	0	1	1	1	0	DH	DL						I	$M \leftarrow (M) + I$	Calculates the logic-OR of the immediate data and the contents of M and stores the result in M			
EXL	r	M	Exclusive-OR M with r	0	0	1	0	0	0	DH	DL						Rn	$r \leftarrow (r) \oplus (M)$	Calculates the logic-XOR of the contents of r and M, and stores the result in r			
Load and store instructions																						
LD	r	M	Load M into r	1	0	0	0	0	0	DH	DL						Rn	$r \leftarrow (M)$	Moves the contents of M to r			
ST	M	r	Store r in M	1	0	0	0	0	1	DH	DL						Rn	$M \leftarrow (r)$	Moves the contents of r to M			
MVDR	r	M	Move M to M addressed by Rn	1	0	0	0	1	0	DH	DL						Rn	$[DH, Rn] \leftarrow (M)$	Moves the contents of M to the address referenced by DH and Rn			
MVRS	M	r	Move M addressed by Rn to M	1	0	0	0	1	1	DH	DL						Rn	$M \leftarrow [DH, Rn]$	Moves the contents of the memory location referenced by DH and Rn to M			
MVSR	M1	M2	Move M to M	1	0	0	1	0	0	DH	DL1	DL2					DL2	$[DH, DL1] \leftarrow [DH, DL2]$	Moves the contents of memory location 2 to memory location 1			
MM	M	I	Move I to M	1	0	0	1	0	1	DH	DL						I	$M \leftarrow I$	Moves the immediate data to M			
PLL	M	r	Load M to PLL registers	1	0	0	1	1	0	DH	DL						Rn	$PLLr \leftarrow (M)$	Moves the contents of M to the PLL registers			

Mnemonic	Operand		Operation	Instruction format																Description	Skip condition				
	1st	2nd		Bit test instructions																					
				D15	D14	D13	D12	D11	D10	D9	D8	D7	D6	D5	D4	D3	D2	D1	D0						
TMT	M	N	Test bits of M and skip if true	1	0	1	0	1	0	0	1	DH	DL	N	Skip if M(N) = all 1			Tests the bits of memory location M specified by N. Skips if all bits are logic 1	All bits specified = 1						
TMF	M	N	Test bits of M and skip if false	1	0	1	0	1	1	0	1	DH	DL	N	Skip if M(N) = all 0			Tests the bits of memory location M specified by N. Skips if all bits are logic 0	All bits specified = 0						
Jump and subroutine instructions																									
JMP	ADDR		Jump to address	1	0	1	1	ADDR (12 bits)								PC ← ADDR			Jumps to the address specified by ADDR						
CAL	ADDR		Call subroutine	1	1	0	0	ADDR (12 bits)								Stack ← (PC) + 1, PC ← ADDR			Jumps to the subroutine specified by ADDR						
RT			Return from subroutine	1	1	0	1	0	1	0	1	0	0	0	0	0	0	PC ← stack			Returns from a subroutine				
Flag test instructions																									
TTM	N		Test timer flip-flop	1	1	0	1	0	1	1	0	0	0	0	0	0	N	Skip if timer F/F = 0			Tests the timer flip-flop and skips if zero	Timer F/F = 0			
TUL	N		Test PLL flip-flop	1	1	0	1	0	1	1	0	0	0	0	0	N	Skip if PLL F/F = 0			Tests the PLL-unlocked flip-flop and skips if zero	PLL F/F = 0				
Status register test and set instructions																									
SS	N		Set status register bit	1	1	0	1	1	1	0	0	0	0	0	0	N	(Status register 1) N ← 1			Sets the bits of the status register specified by N					
RS	N		Reset status register bit	1	1	0	1	1	1	0	1	0	0	0	N	(Status register 1) N ← 0			Resets the bits of the status register specified by N						
TST	N		Test status register bits and skip if true	1	1	0	1	1	1	1	0	0	0	0	N	Skip if (status register 2) N = all 1			Tests the bits of status register 2. Skips if all bits are 1	All bits specified = 1					
TSF	N		Test status register bits and skip if false	1	1	0	1	1	1	1	1	0	0	0	N	Skip if (status register 2) N = all 0			Tests the bits of status register 2. Skips if all bits are 0	All bits specified = 0					
Bank select instruction																									
BANK	B		Select bank	1	1	0	1	0	0	0	0	B	0 0 0 0				0 0 0 0				BANK ← B			Selects one of four memory banks	
Input/output instructions																									
LCD	M	I	Move data to LCD segments	1	1	1	0	0	0	0	DH	DL				DIGIT				LCD (DIGIT) ← I			Loads the immediate data directly to the LCD driver		
LCP	M	I	Move 7-segment data to LCD	1	1	1	0	0	1	DH	DL				DIGIT				LCD (DIGIT) ← PLA ← I			Converts the immediate data to 7-segment format using a PLA then transfers it to the LCD driver			
IN	M	P <sub>n</sub>	Move port data to M	1	1	1	0	1	0	DH	DL				P				M ← (port (P <sub>n</sub> ))			Moves the data from input port P <sub>n</sub> to M			

Mnemonic	Operand		Operation	Instruction format												Notation	Description	Skip condition				
	1st	2nd		D15	D14	D13	D12	D11	D10	D9	D8	D7	D6	D5	D4				D3	D2	D1	D0
	M	Pn		1	1	1	0	1	1	DH	DL	P	N	N	N				N	N	N	(Port (Pn)) ← M
OUT	M	Pn	Move data to port	1	1	1	0	1	1	0	0	0	0	0	0	0	0	0	(Port (Pn)) ← M	Moves the contents of memory location M to port Pn		
SPB	Pn	N	Set port bits	1	1	1	1	0	0	0	0	0	0	0	0	0	0	0	(Port (Pn)) N ← 1	Sets the bits of port Pn, specified by N, to logic 1		
RPB	Pn	N	Reset port bits	1	1	1	1	0	1	0	1	0	1	0	1	0	1	0	(Port (Pn)) N ← 0	Sets the bits of port Pn, specified by N, to logic 0		
TPT	Pn	N	Test bits of port and skip if true	1	1	1	1	1	0	1	0	1	0	1	0	1	0	1	Skip if (port (Pn)) N = all 1	Tests the bits of port Pn, specified by N. Skips if all bits are logic 1	All bits specified = 1	
TPF	Pn	N	Test bits of port and skip if false	1	1	1	1	1	1	1	1	1	1	1	1	1	1	1	Skip if (port (Pn)) N = all 0	Tests the bits of port Pn, specified by N. Skips if all bits are logic 0	All bits specified = 0	
Universal counter instructions																						
UCS	I		Set UCCW1	0	0	0	0	0	0	0	0	0	0	0	0	0	0	0	UCCW1 ← 1	Sets the universal counter flag 1		
UCC	I		Set UCCW2	0	0	0	0	0	0	1	1	0	0	0	0	0	0	0	UCCW2 ← 1	Sets the universal counter flag 2		
Miscellaneous instructions																						
FPC	N		Port F direction control	0	0	0	1	0	0	0	0	0	0	0	0	0	0	0	FPC latch ← N	Defines the direction of individual pins of port F. If a bit in the port F direction register is set by FPC, the corresponding pin of port F becomes an output.		
CSSTP			Stop clock	0	0	0	1	0	0	1	0	0	0	0	0	0	0	0	Stop clock if HOLD = 0	Stops the processor clock if HOLD = 0		
DAC	I		Move data to DAC registers	0	0	0	0	0	0	1	0	0	0	0	0	0	0	0	DACr ← 1	Loads the immediate data to the DAC registers		
NOP			No operation	0	0	0	0	0	0	0	0	0	0	0	0	0	0	0		No operation		

**MASK OPTIONS**

Parameter	Options
Watchdog timer (WDT)	Yes
	No
Pull-down resistors on port A (the keypad matrix input port)	Yes
	No
Instruction cycle time	2.67 $\mu$ s
	13.33 $\mu$ s
	40.00 $\mu$ s
S1 to S23 configuration	LCD driver output port
	General-purpose output port

**DEVELOPMENT SYSTEM**

The LC7233 development environment is shown in figure 1. It uses an LC72EV32 evaluation chip mounted on a TB-72EV32 target board and a multifunctional emulator (RE32), which is controlled by a personal computer, to provide full debugging facilities.

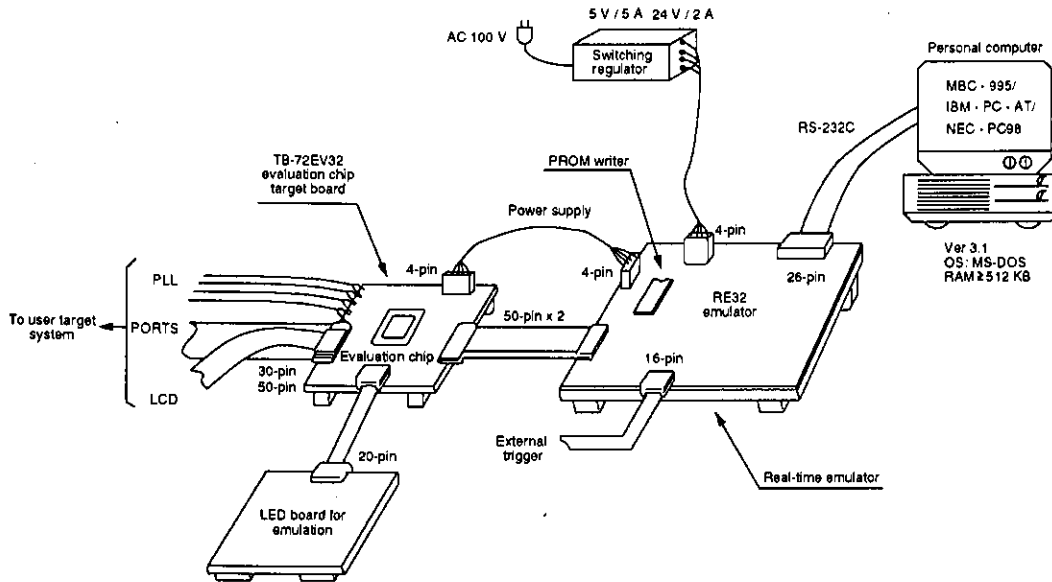

Figure 1. Development system