

Overview

The LC7584N is an LCD driver which has the serial interface with a microcomputer, and controls and drives a 1/2-duty LCD. It supports a segment display and level meter display.

The segment display enables up to 6 characters (that is, 6-digit display layout. 14 segments per digit) to be displayed at the same time.

The character generator (CG) generates the segment patterns to display sixty-four characters, symbols and the like on the LCD panel.

Any segment pattern can be generated not via the programmable logic array CG circuit. The level meter display enables the data output from the on-chip 5-bit AD converter on the LCD panel.

Features

1. 1/2 duty-1/2 bias 96 segments (maximum. Note that the number of segments used for level meter display and direct display is not included here.)
2. Number of characters displayed at the same time = 6 digits (maximum). 14 segments per digit. Characters, symbols and so on to be displayed = 64 kinds
3. Characters and any segment pattern can be displayed on the LCD panel at the same time.
4. Display pin provided for direct display (\overline{DSPI} and $\overline{DSP2}$ pins)
5. On-chip 5-bit AD converter. The following three level output modes are available.
 - (1) 13-ladder x 2 channels --- Log scale (with peak hold function)
 - (2) 13-ladder x 2 channels --- Linear scale (with peak hold function)
 - (3) 26-ladder x 1 channel --- Linear scale
6. The reset time of the peak hold latch circuit for level output can be determined by an external CR time constant.
7. All of these LSI chip functions can be controlled by the seven commands from a microcomputer.

LC7584N

Package Dimensions 3044B (unit: mm)

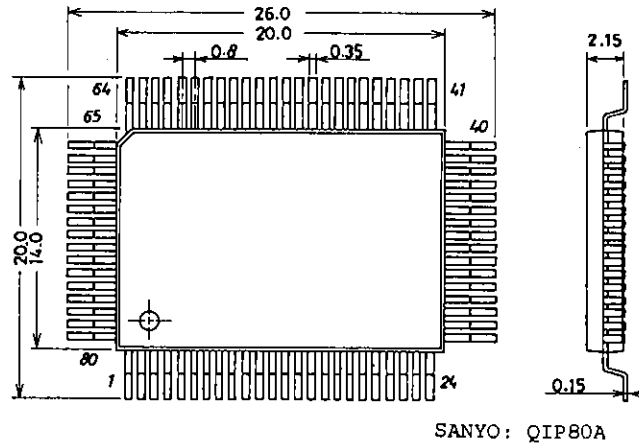

Pin layout

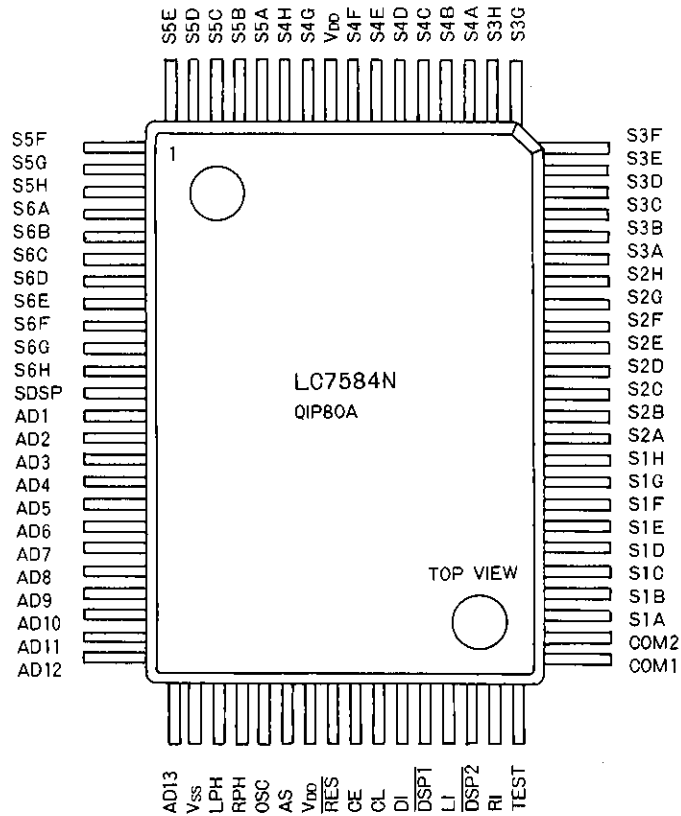

LC7584N

Absolute maximum ratings at Ta=25°C, Vss=0V

				unit
Supply voltage	V _{DD}		-0.3 to +6.5	V
Input voltage	V _{IN} (1)	RES, CE, CL, DI, DSP1, DSP2	-0.3 to +6.5	V
	V _{IN} (2)	LPH, RPH, LI, RI, OSC, AS	-0.3 to V _{DD} +0.3	V
Output voltage	V _{OUT}	LPH, RPH, OSC, all output pins	-0.3 to V _{DD} +0.3	V
Maximum power dissipation	P _{dmax}	Ta ≤ 85°C	200	mW
Operating ambient temperature	T _{opr}		-40 to +85	°C
Storage ambient temperature	T _{stg}		-50 to +125	°C

Allowable operating conditions at Ta=-40 to 85°C, Vss=0V

			min	typ	max	unit
Supply voltage	V _{DD} (1)	AD converter used	4.0		5.5	V
	V _{DD} (2)	AD converter not used	3.0		5.5	V
H-level input voltage	V _{IH} (1)	RES, CE, CL, DI	0.6V _{DD}		5.5	V
	V _{IH} (2)	DSP1, DSP2	0.7V _{DD}		5.5	V
	V _{IH} (3)	AS	0.7V _{DD}		V _{DD}	V
L-level input voltage	V _{IL} (1)	RES, CE, CL, DI	0		0.2V _{DD}	V
	V _{IL} (2)	DSP1, DSP2	0		0.3V _{DD}	V
	V _{IL} (3)	AS	0		0.3V _{DD}	V
Input voltage	V _{IN}	LI, RI	0		V _{DD}	V
Oscillation frequency	f _{osc}	OSC		160		kHz
Recommended external resistance	R _{osc}	OSC		36		kΩ
Recommended external capacitance	C _{osc}	OSC		220		pF
Recommended external resistance	R _{PH}	LPH, RPH			700	kΩ
Recommended external capacitance	C _{PH}	LPH, RPH			15	μF
Minimum operational pulse width	P _{RES}	RES	1.0			μs

Electrical characteristics		Under the allowable operational conditions	min	typ	max	unit
H-level input current	I _{IH}	RES, CE, CL, DI, DSP1, DSP2 (V _I =5.5V)			5.0	μA
L-level input current	I _{IL}	RES, CE, CL, DI, DSP1, DSP2 (V _I =V _{SS})			5.0	μA
Pull-down resistance	R _{PD}	TEST		50		kΩ
Hysteresis width	V _H	CE, CL, DI	0.03V _{DD}			V
L-level output voltage	V _{OL} (1)	OSC (I _o =1mA)			2.0	V
	V _{OL} (2)	LPH, RPH (I _o =1mA)			0.1	V
Oscillation frequency	f _{osc} (1)	OSC (C=220pF R=36kΩ, V _{DD} (1))	130	160	200	kHz
	f _{osc} (2)	OSC (C=220pF R=36kΩ, V _{DD} (2))	120	160	200	kHz

Continued on next page.

Continued from preceding page.

			min	typ	max	unit
H-level input threshold voltage	$V_{TH}(1)$	OSC	$0.45V_{DD}$	$0.5V_{DD}$	$0.55V_{DD}$	V
	$V_{TH}(2)$	LPH,RPH	$0.45V_{DD}$	$0.5V_{DD}$	$0.55V_{DD}$	V
AD conversion error	AD_{ERR}	LI,RI	-1/2		1/2	LSB
H-level output voltage	$V_{OH}(1)$	Smn,ADm,SDSP ($I_o=0.1mA, V_{DD}(1)$)	$V_{DD}-0.5$			V
	$V_{OH}(2)$	($I_o=0.1mA, V_{DD}(2)$)	$V_{DD}-0.7$			V
L-level output voltage	$V_{OL}(3)$	Smn,ADm,SDSP ($I_o=0.1mA, V_{DD}(1)$)			0.5	V
	$V_{OL}(4)$	($I_o=0.1mA, V_{DD}(2)$)			0.7	V
H-level output voltage	$V_{OH}(3)$	COM1,COM2 ($I_o=0.1mA$) ($C_M=0;2k\Omega$)	$V_{DD}-0.3$	$V_{DD}-0.2$	$V_{DD}-0.1$	V
L-level output voltage	$V_{OL}(5)$	COM1,COM2 ($I_o=0.1mA$) ($C_M=0;2k\Omega$)	0.1	0.2	0.3	V
H-level output voltage	$V_{OH}(4)$	COM1,COM2 ($I_o=0.01mA$) ($C_M=1;50k\Omega$)	$V_{DD}-0.7$	$V_{DD}-0.5$	$V_{DD}-0.3$	V
L-level output voltage	$V_{OL}(6)$	COM1,COM2 ($I_o=0.01mA$) ($C_M=1;50k\Omega$)	0.3	0.5	0.7	V
Intermediate level voltage	V_{MID}	COM1,COM2 (Pin='open') ($C_M=0,1$)	$0.45V_{DD}$	$0.5V_{DD}$	$0.55V_{DD}$	V
Supply current	$I_{DD}(1)$	ADC used ($C_M=0;2k\Omega$) Note 1		2.5	4.0	mA
Supply current	$I_{DD}(2)$	ADC not used ($C_M=0;2k\Omega$) Note 1		1.8	3.0	mA
Supply current	$I_{DD}(3)$	ADC used ($C_M=1;50k\Omega$) Note 1		1.0	2.0	mA
Supply current	$I_{DD}(4)$	ADC not used ($C_M=1;50k\Omega$) Note 1		0.5	1.0	mA
High-level clock pulse width	t_{H}	CL	0.5			μs
Low-level clock pulse width	t_{L}	CL	0.5			μs
Data set-up time	t_{SU}	CL,DI	0.5			μs
Data hold time	t_{DH}	CL,DI	0.5			μs
CE set-up time	t_{CU}	CL,CE	1.0			μs
CE clock time	t_{CL}	CL,CE	0.5			μs
CE hold time	t_{CH}	CL,CE	0.5			μs

Note 1: $f_{osc} = 160kHz$ and output pins = 'open'.

CE, CL and DI timings

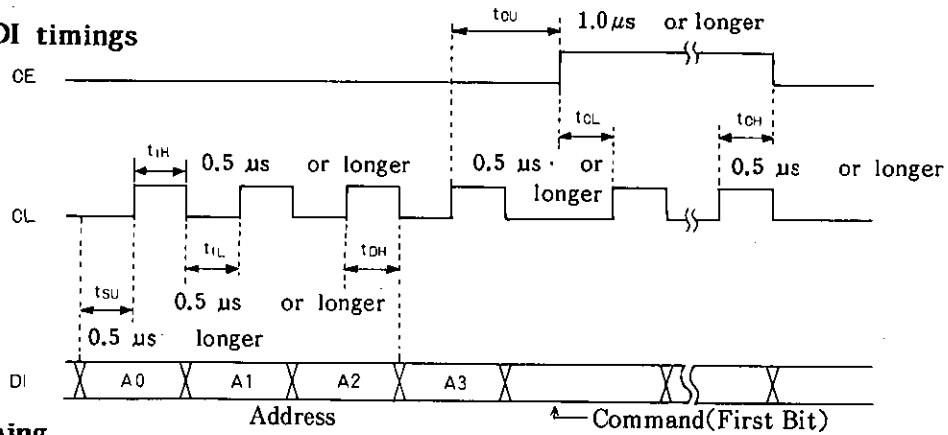

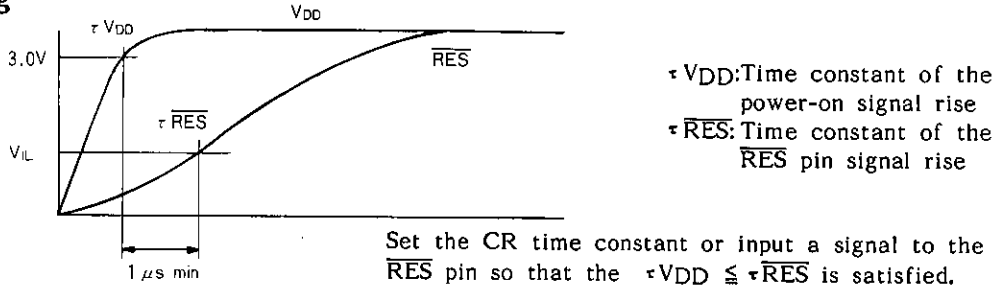

VDD-RES timing



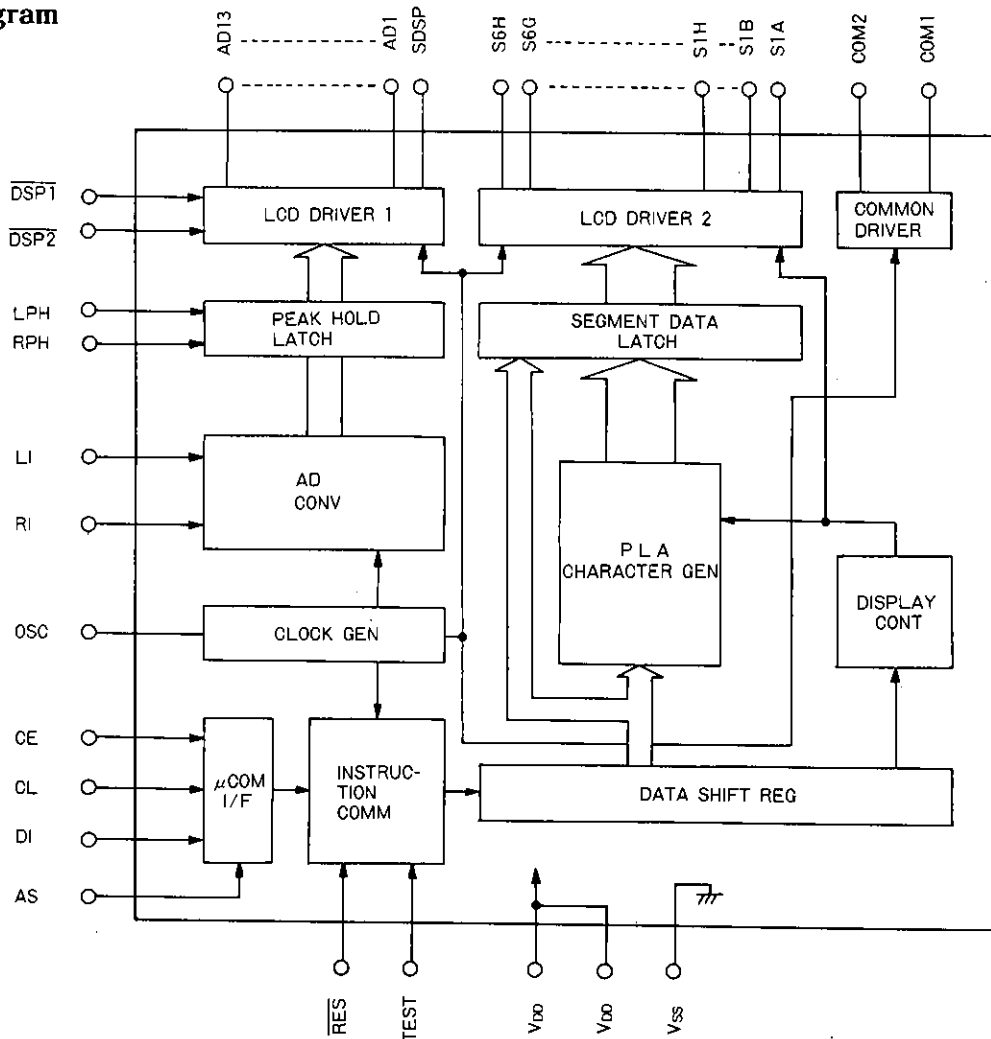

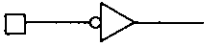
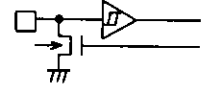
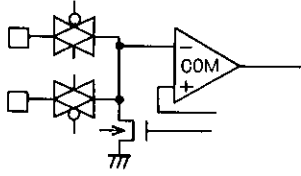
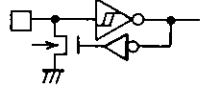
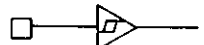

Block diagram

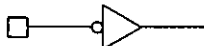
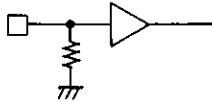

Pin description

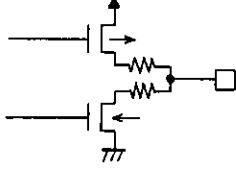
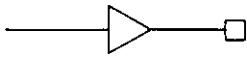
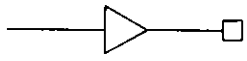
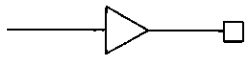
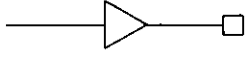
Pin name	Pin No.	Pin design	Description																							
$\overline{\text{DSP1}}$ $\overline{\text{DSP2}}$	3 6 3 8		<ul style="list-style-type: none"> Input pin used for direct (external input) display The segment drive signals are output from the SDSP pin. COM1: $\overline{\text{DSP1}}$, COM2: $\overline{\text{DSP2}}$ 																							
LPH RPH	2 7 2 8		<ul style="list-style-type: none"> CR connection pins for determining the reset time of the peak hold circuit for level meter display. 																							
LI RI	3 7 3 9		<ul style="list-style-type: none"> Input pin for AD converter. Full scale: $(31/48)V_{DD}$ 																							
OSC	2 9		<ul style="list-style-type: none"> CR connection pin for oscillation 																							
CE CL DI	3 3 3 4 3 5		<ul style="list-style-type: none"> Serial data input pin. CE: Chip enable. CL: Synchronous clock. DI: Input serial data 																							
AS	3 0		<ul style="list-style-type: none"> Address select input pin. The signal inputs to this pin are meaningful when the two LC7584N chips are used. <table border="1" data-bbox="933 1377 1452 1579"> <thead> <tr> <th rowspan="2">AS pin</th> <th colspan="4">Address</th> <th>HEX</th> </tr> <tr> <th>A0</th> <th>A1</th> <th>A2</th> <th>A3</th> <th>CODE</th> </tr> </thead> <tbody> <tr> <td>L</td> <td>0</td> <td>0</td> <td>1</td> <td>0</td> <td>4</td> </tr> <tr> <td>H</td> <td>1</td> <td>0</td> <td>1</td> <td>0</td> <td>5</td> </tr> </tbody> </table>	AS pin	Address				HEX	A0	A1	A2	A3	CODE	L	0	0	1	0	4	H	1	0	1	0	5
AS pin	Address				HEX																					
	A0	A1	A2	A3	CODE																					
L	0	0	1	0	4																					
H	1	0	1	0	5																					
$\overline{\text{RES}}$	3 2		<ul style="list-style-type: none"> Reset signal input pin. If this pin becomes active, the LSI will be initialized and all the LCD segments are then forcibly turned off. To turn on the LCD segments, commands are transmitted to the LC7584N from a microcomputer. 																							
TEST	4 0		<ul style="list-style-type: none"> Left open or connected to the VSS level. 																							

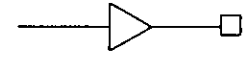
LC7584N

Pin name	Pin No.	Pin design	Description
V _{DD}	3 1 7 3		<ul style="list-style-type: none"> • Voltage supply pin. Applies voltage in the range between 4.0V and 5.5V. If the on-chip AD converter is not used, it is possible to decrease down to 3.0V.
V _{SS}	2 6		<ul style="list-style-type: none"> • Ground pin.
COM 1 COM 2	4 1 4 2		<ul style="list-style-type: none"> • LCD common driver pins. Frame frequency = fosc/1024 Hz.
S 1 A to S 1 H	4 3 to 5 0		<ul style="list-style-type: none"> • LCD segment driver pins: <for the first display digit>
S 2 A to S 2 H	5 1 to 5 8		<ul style="list-style-type: none"> • LCD segment driver pins: <for the second display digit>
S 3 A to S 3 H	5 9 to 6 6		<ul style="list-style-type: none"> • LCD segment driver pins: <for the third display digit>
S 4 A to S 4 H	6 7 to 7 5		<ul style="list-style-type: none"> • LCD segment driver pins: <for the fourth display digit>
S 5 A to S 5 E S 5 F to S 5 H	7 6 to 8 0 1 to 3		<ul style="list-style-type: none"> • LCD segment driver pins: <for the fifth display digit>
S 6 A to S 6 H	4 to 1 1		<ul style="list-style-type: none"> • LCD segment driver pins: <for the sixth display digit>
S DSP	1 2		<ul style="list-style-type: none"> • LCD segment driver pin: <direct ($\overline{\text{DSP1}}$ and $\overline{\text{DSP2}}$) display>
AD 1 to AD 1 3	1 3 to 2 5		<ul style="list-style-type: none"> • LCD segment drivers: <AD converter level display>. AD1: lowest level. AD13: highest level.

Control data (serial data command) format

Command list

Command type	Function	Serial data				(HEX)
Control [CTL]	Initializes the LSI. This command is required each time the LSI is powered on.	1	0	0	0	1
Display 1 [DP1]	Turns off the drivers of a specified digit and the ADC drivers.	0	1	0	0	2
Display 2 [DP2]	Turns on the drivers of a specified digit and the ADC drivers.	1	1	0	0	3
Data 1 [DT1]	Updates the content of a specified digit: Via the PLA character generator.	0	0	1	0	4
Data 2 [DT2]	Updates the contents of all the digits: Via the PLA character generator.	1	0	1	0	5
Data 3 [DT3]	Updates the content of a specified digit: Any display data. Resets the data 2 inhibit flag.	0	1	1	0	6
Data 4 [DT4]	Updates the content of a specified digit: Any display data. Sets the data 2 inhibit flag.	1	1	1	0	7

Command processing time

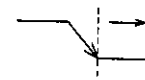
Command	Processing time	(CE :  Processing starts after this.)
Control [CTL]	$2 \times \frac{1}{f_{osc}}$ s	(12.5 μs : fosc = 160KHz)
Display 1 [DP1]	$10 \times \frac{1}{f_{osc}}$ s	(62.5 μs : t)
Display 2 [DP2]	$10 \times \frac{1}{f_{osc}}$ s	(62.5 μs : t)
Data 1 [DT1]	$10 \times \frac{1}{f_{osc}}$ s	(62.5 μs : t)
Data 2 [DT2]	$22 \times \frac{1}{f_{osc}}$ s	(137.5 μs : t)
Data 3 [DT3]	$10 \times \frac{1}{f_{osc}}$ s	(62.5 μs : t)
Data 4 [DT4]	$10 \times \frac{1}{f_{osc}}$ s	(62.5 μs : t)

* The next command should not be sent to the LSI from a microcomputer until the current command processing is complete. The transfer of the next command would cause an operational error in such a situation.

(1) Control --- <Initializes the LSI. This command is required each time the LSI is powered on.>

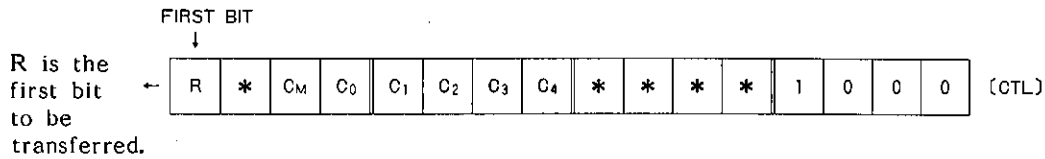

R : Resets the LSI. This serial data places the AD converter and the LCD drivers in halt mode operation.
 0 → Reset; Release
 1 → Reset; Initialization (ADC display, direct display and all display digits; OFF)

(The LSI can be also initialized by inputting an 'L' level signal to the $\overline{\text{RES}}$ pin (active low). However, the serial command data should be used to release the LSI from the initialization mode.)

CM : Selects a 1/2 divider resistance value of the LCD common drivers (COM1, COM2) from the following two values.
 0 → 2 kΩ
 1 → 50 kΩ

C0 : Controls the peak hold circuit used for ADC level meter display.
 0 → Inactivates the peak hold circuit.
 1 → Activates the peak hold circuit.

C1 and C2 : Selects an ADC display mode from the following four operation modes:
 0 0 → Places the ADC in halt operation mode.
 1 0 → Selects the 26-ladder x 1 channel linear scale display operation mode (with peak hold circuit disabled).
 0 1 → Selects the 13-ladder x 2 channels log scale display operation mode.
 1 1 → Selects the 13-ladder x 2 channels linear scale display operation mode.

※ If the 1 channel operation mode is selected, the same signal should be input to both of the LI and RI pins.
 If the 2 channel operation mode is selected, two independent signals should be input to the LI and RI pins separately.

C3 and C4 : Selects an ADC display update cycle from the following four values.
 0 0 → $2^{10} / f_{osc}$ s (6.7 ms ; $f_{osc} = 160\text{kHz}$)
 1 0 → $2^{13} / f_{osc}$ s (50 ms ; $f_{osc} = 160\text{kHz}$)
 0 1 → $2^{14} / f_{osc}$ s (100 ms ; $f_{osc} = 160\text{kHz}$)
 1 1 → $2^{15} / f_{osc}$ s (200 ms ; $f_{osc} = 160\text{kHz}$)

*: Indicates that these bits can be set to 'H' or 'L'.

※: AD converter halt : LI and RI pins are pulled down to the Vss level. AD1 to AD13 pins (segment pins) are also pulled down to the Vss level.

LCD driver halt : S1A to S6H, and SDSP (segment pins) pins ; Vss.
 COM1 and COM2 ; Vss.

(2) Display --- <Turns ON/OFF the LCD drivers of a specified digit and the ADC display drivers>

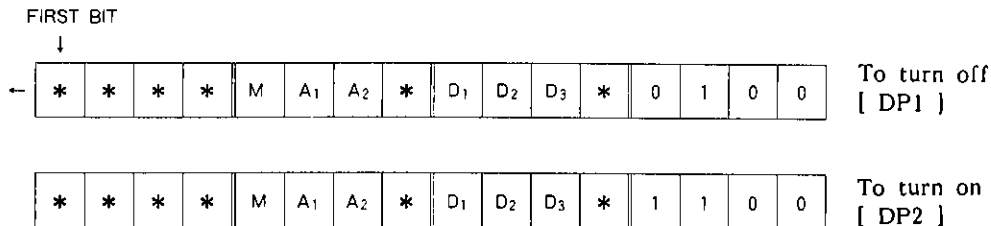

M, A1, A2 : Specifies the type(s) of data (MDATA, ADATA).

M → 1: MDATA

A1 → 1: A1DATA

A2 → 1: A2DATA

D1, D2, D3 : Specifies a display digit to be turned ON/OFF.

0 0 0 → ADC display

1 0 0 → The first display digit

0 1 1 → The sixth display digit

1 1 1 → All the display digits (first to sixth digits)

*: indicates that these bits can be set to 'H' or 'L'.

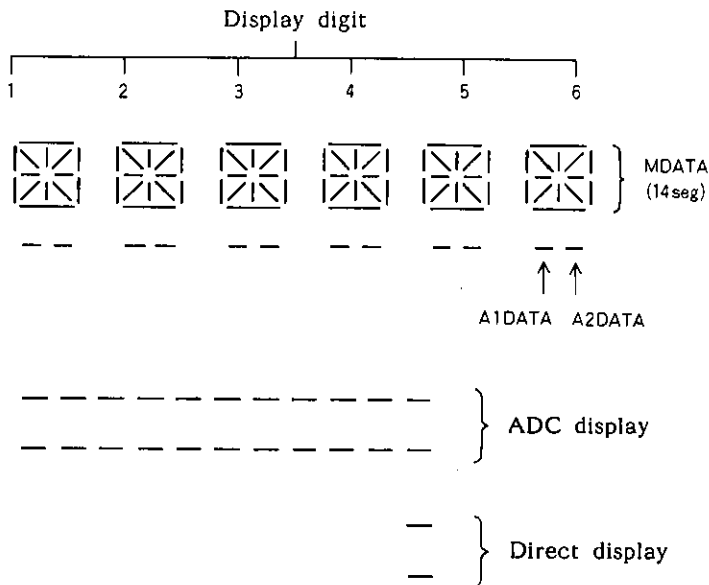

※ MDATA : Characters, symbols and so on displayed via the PLA character generator.

A1, A2 DATA : Any display data.

After reset : The [DP2] command should be executed in order that the LSI can be released from reset mode. This does not apply to the direct display mode.

(3) Data 1 --- <Updates the display data of a specified digit: Via the PLA character generator>

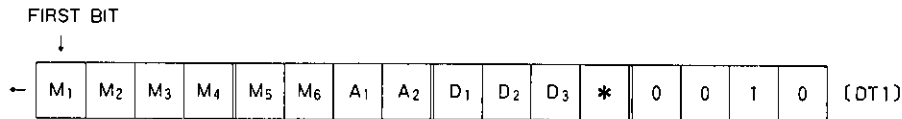

M₁ to M₆ : Input data (MDATA) to the PLA character generator. It enables the character generator to generate up to 64 kinds of characters, symbols and so on. Each display data requires 14 segments.

A₁ and A₂ : Additional data directly from a microcomputer (memory), not via the PLA character generator. That is, any segment data can be sent from the microcomputer as additional data when these bits are set. (A₁, A₂ DATA)

D₁ to D₃ : Specifies the digit of which data is updated.
 0 0 0 → No update
 1 0 0 → The first digit data
 ⋮
 0 1 1 → The sixth (last) digit data
 1 1 1 → All of the digits will be updated.

(4) Data 2 ---<Updates the display data of all the digits: Via the PLA character generator>

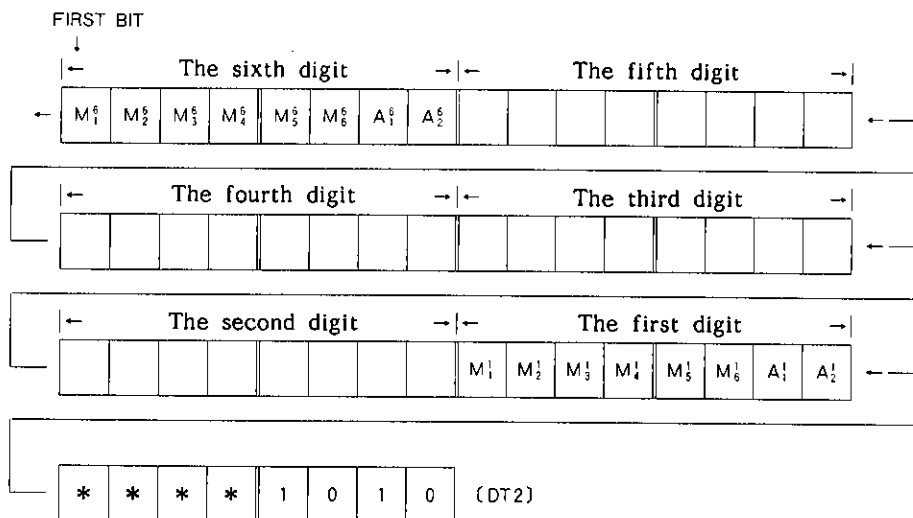

M₁ⁿ to M₆ⁿ : Input data (MDATA) to the PLA character generator. It enables the character generator to generate up to 64 kinds of characters, symbols and so on. Each display data requires 14 segments.

A₁ⁿ and A₂ⁿ : Additional data. These bits are used together with the preceding six bits (M₁ to M₆) to generate any segment pattern. Note that these two segment control bits are directly output from a microcomputer and then used to drive the A₁DATA and A₂DATA segment directly while the preceding six bits are input to the PLA character generator.

※ If a certain digit has been masked by the data 4 [DT4] command, the display data of the digit cannot be updated. Note that the DT4 command has the function to set the data 2 inhibit flag.

* : Indicates that these bits can be set to 'H' or 'L'.

- (5) Data 3 and 4 commands ---<Updates the display data of a specified digit : any display data>

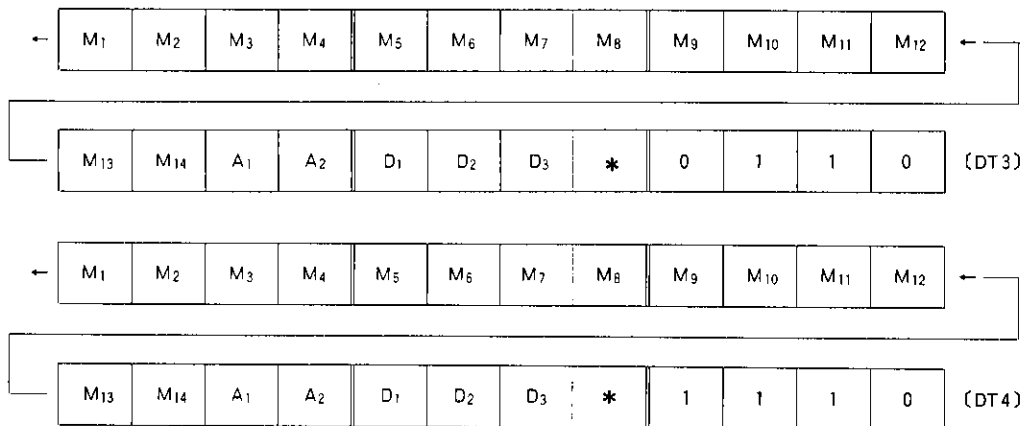

M₁ to M₁₄ : Display data directly used to drive segments to generate any segment pattern. These bits are not input to the PLA character generator.
(MDATA)

A₁ and A₂ : Additional data. These two bits are directly used to drive segments to generate any segment pattern together with bits M₁ to M₁₆.
(A₁ and A₂ DATA)

D₁ to D₃ : Specifies the digit of which display data is updated.
 0 0 0 → No update
 1 0 0 → The first digit
 ⋮
 0 1 1 → The sixth digit
 1 1 1 → All the digits

- ※ The [DT3] command has the function to reset the DATA 2 inhibit flag.
 The [DT4] command has the function to set the DATA 2 inhibit flag.
 The [DT3] and [DT4] commands are used to set or reset the inhibit flag which corresponds to the digit specified by D₁ to D₃.
 If the flag controlling a certain digit has been set and the [DT2] command is executed, the display data of that digit is not updated.
 In this case, the display data specified by the [DT3] or [DT4] command remains unchanged.
 Note that the [DT1] command can be used to update the current display data of any digit, irrespectively of flags.
 When the LSI is reset, the data 2 inhibit flag will be also reset.

LCD panel layout <fig 1>

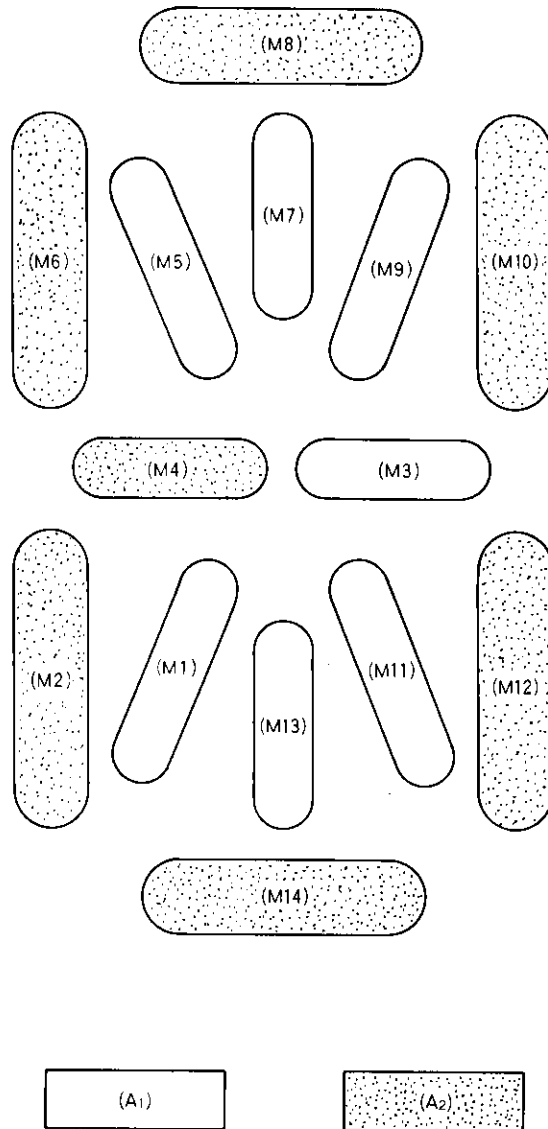

nth digit (n: 1 to 6)

Pin name	SnA	SnB	SnC	SnD	SnE	SnF	SnG	SnH
COM1	M2	M4	M6	M8	M10	M12	M14	A ₂
COM2	M1	M3	M5	M7	M9	M11	M13	A ₁

LCD common connection

(1) Direct display (DSP 1 , DSP 2)

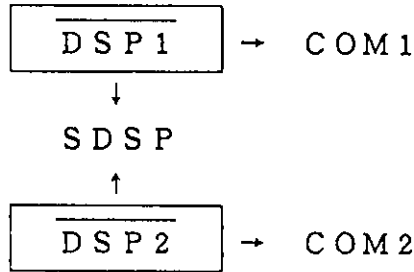

(2) ADC display mode

- 2-channel (stereo) display mode (Only the data from one of the two is displayed)
- <fig 2>

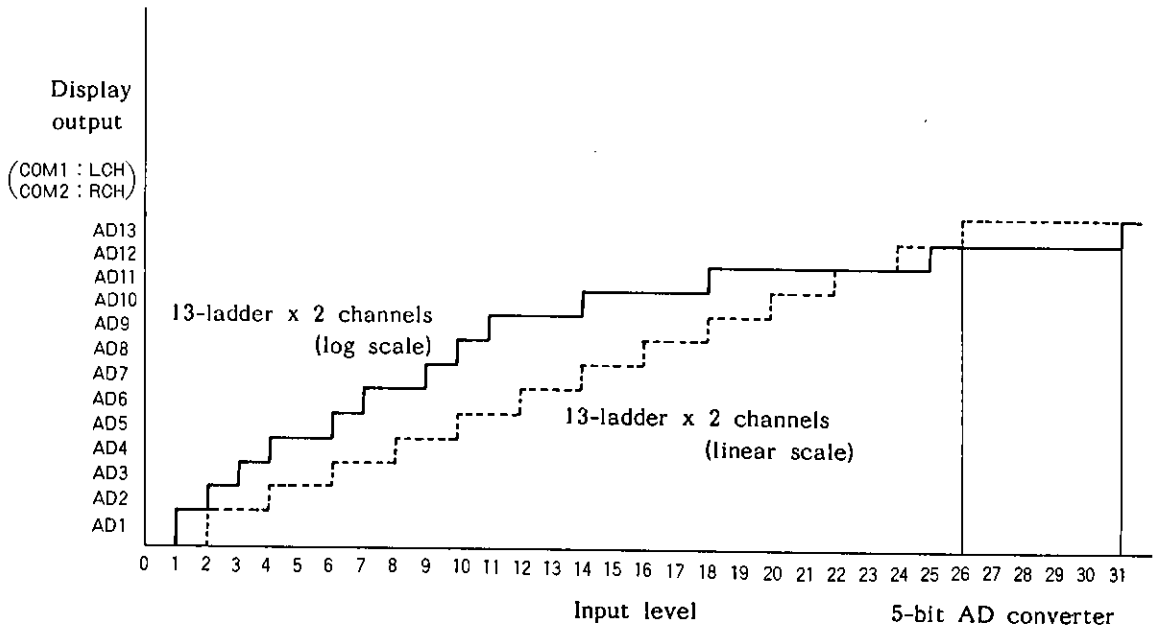

COMMON connection

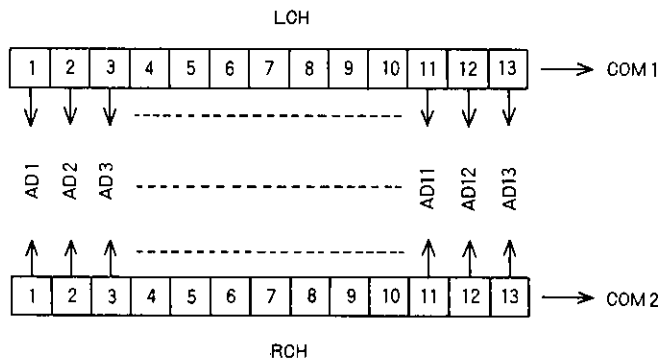

- One-channel (monaural) display mode <fig 3>

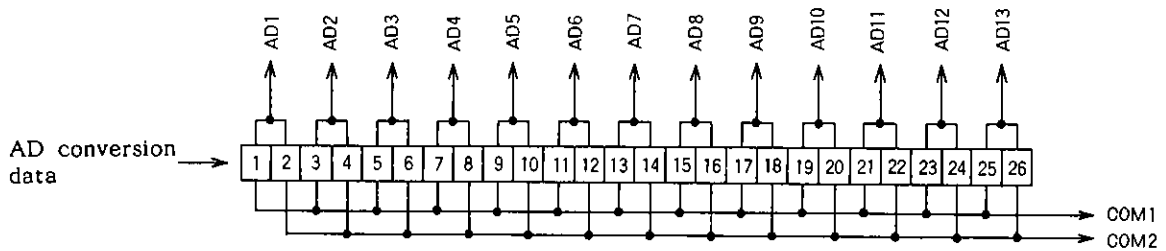
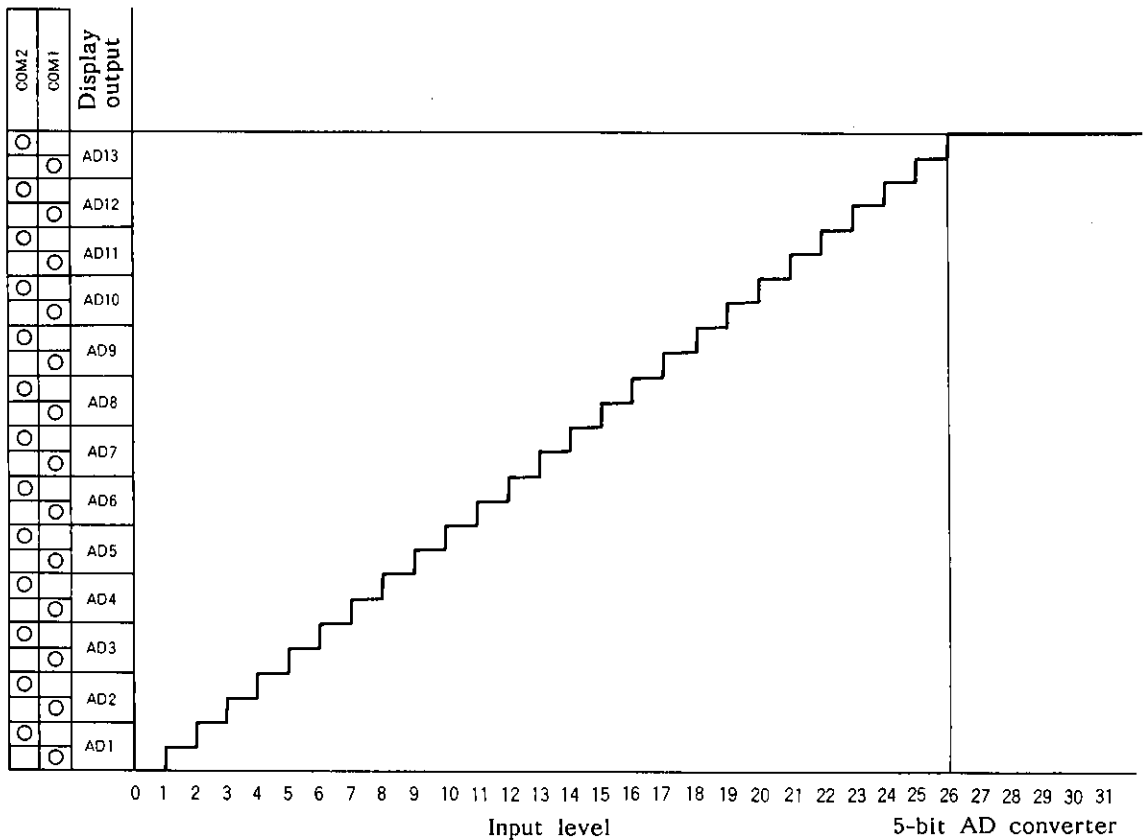

When the monaural display operation is employed, the RI and LI pins should be wired together.

※ AD converter reference voltage (laboratory value); V_{ref}

$$V_{ref} = \frac{1}{3} V_{DD} (D_4 + \frac{1}{2} D_3 + \frac{1}{4} D_2 + \frac{1}{8} D_1 + \frac{1}{16} D_0)$$

D₀ to D₄ : ADC 5 bits D₀ ; LSB

• LCD driver output signal waveforms <fig 4>

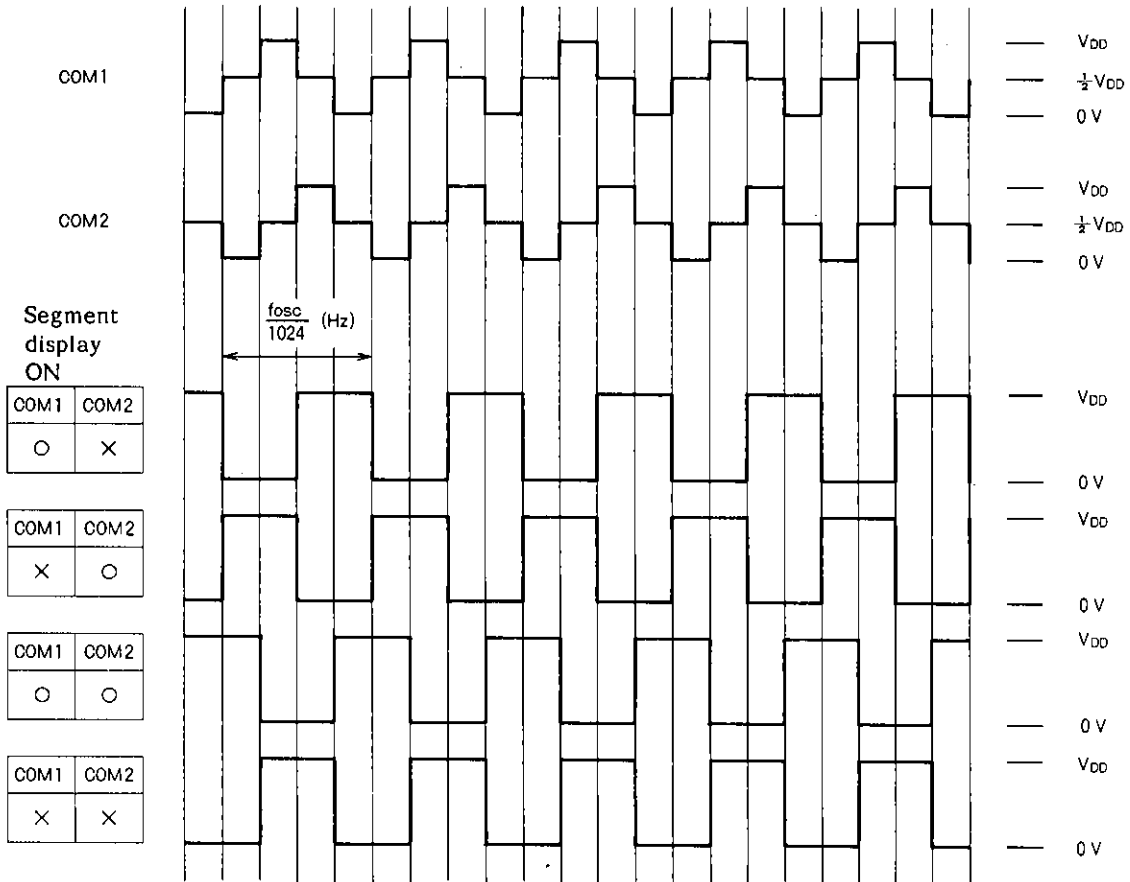

■ No products described or contained herein are intended for use in surgical implants, life-support systems, aerospace equipment, nuclear power control systems, vehicles, disaster/crime-prevention equipment and the like, the failure of which may directly or indirectly cause injury, death or property loss.

■ Anyone purchasing any products described or contained herein for an above-mentioned use shall:

- ① Accept full responsibility and indemnify and defend SANYO ELECTRIC CO., LTD., its affiliates, subsidiaries and distributors and all their officers and employees, jointly and severally, against any and all claims and litigation and all damages, cost and expenses associated with such use:
- ② Not impose any responsibility for any fault or negligence which may be cited in any such claim or litigation on SANYO ELECTRIC CO., LTD., its affiliates, subsidiaries and distributors or any of their officers and employees jointly or severally.

■ Information (including circuit diagrams and circuit parameters) herein is for example only; it is not guaranteed for volume production. SANYO believes information herein is accurate and reliable, but no guarantees are made or implied regarding its use or any infringements of intellectual property rights or other rights of third parties.

Oscillation frequency

The oscillation frequency can be determined based on the values in the figure below.

<fig 5> Oscillation frequencies of the OSC pin and CR time constants

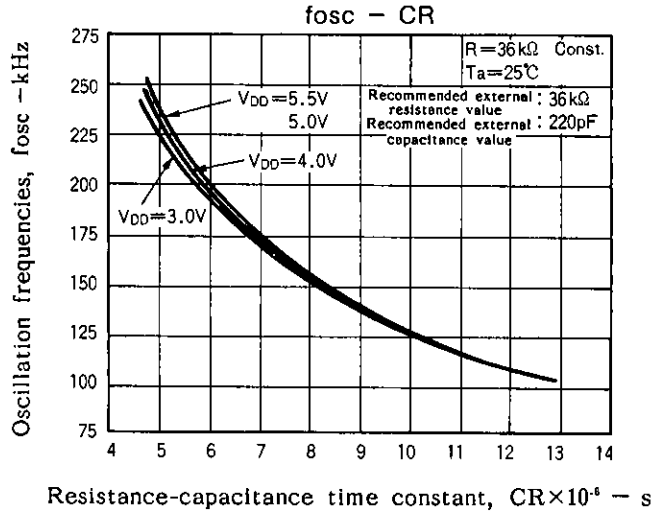

Peak hold time (LPH/RPH)

The peak hold time can be determined based on the following values in the figure below.

<fig 6> Peak hold times and CR time constants

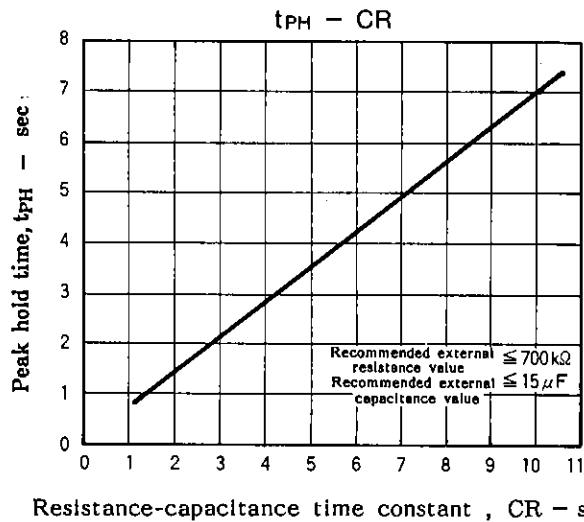

* Peak hold time
t_{PH} (laboratory value)
t_{PH} ≈ 0.69 × CR (s)

[Example]

If R = 430 kΩ
and C = 10 μF
are selected,
the peak hold
time will be
about 3 seconds.

Sample application circuit

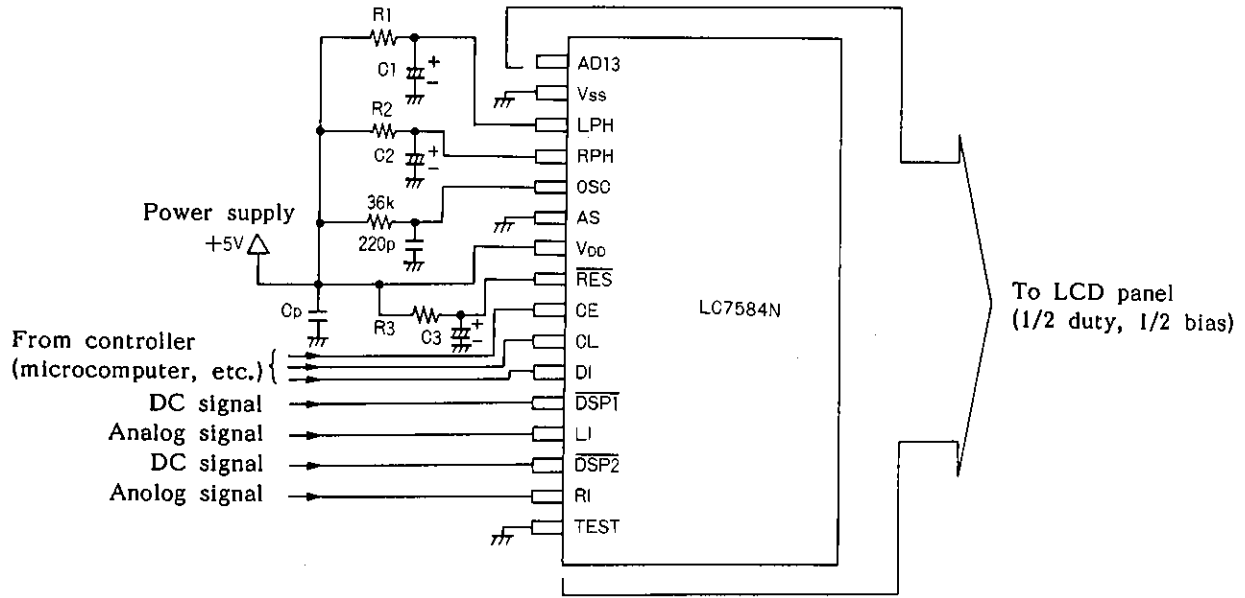

Unit (capacitance: F)

- *1. If $R1=R2=430k\Omega$ and $C1=C2=10\mu F$ are selected, the peak hold time will be about 3 seconds.
- *2. $R3$ and $C3$ are time constant for reset. The time constant can be determined by the characteristic of power-on signal rise. ($PRES > 1\mu S$)
- *3. Cp is a bypass capacitor.

Example of using control data

From power-on to turning-on of the drivers.

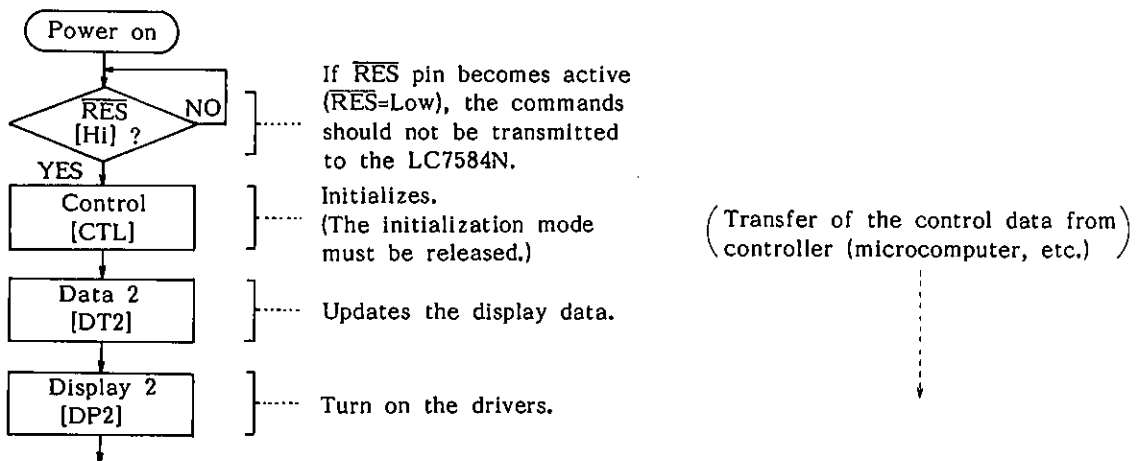

PLA (character generator) conversion code

The serial command data [DT1] or [DT2] can be used to enable up to 64 kinds of characters, symbols and so on to be displayed on the LCD panel via the PLA character generator. (See the LCD panel layout shown in <fig 1>)

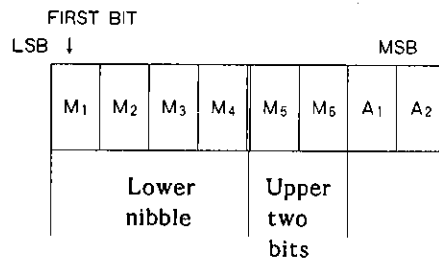

Example 1) Character 'A' is to be displayed.

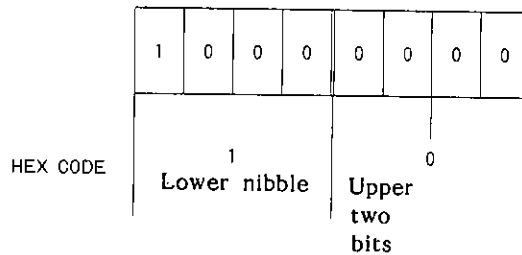



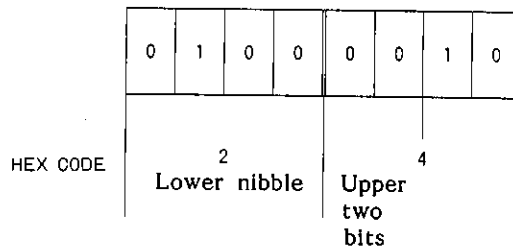





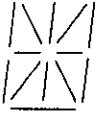





Example 2) Character 'B' is displayed and additional data A₁ is also lit up.

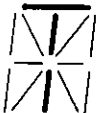

PLA (character generator) conversion code table

Characters (1)

No	Display character	Display segment pattern	HEX CODE	
			Upper two bits	Lower nibble
0	Blank		0	0
1	A		0	1
2	B		0	2
3	C		0	3
4	D		0	4
5	E		0	5
6	F		0	6
7	G		0	7

No	Display character	Display segment pattern	HEX CODE	
			Upper two bits	Lower nibble
8	H		0	8
9	I		0	9
10	J		0	A
11	K		0	B
12	L		0	C
13	M		0	D
14	N		0	E
15	O		0	F

Characters (2) Numbers

No	Display character	Display segment pattern	HEX CODE	
			Upper two bits	Lower nibble
16	P		1	0
17	Q		1	1
18	R		1	2
19	S		1	3
20	T		1	4
21	U		1	5
22	V		1	6
23	W		1	7

No	Display character	Display segment pattern	HEX CODE
24	X		1 8
25	Y		1 9
26	Z		1 A
27	0		1 B
28	1		1 C
29	2		1 D
30	3		1 E
31	4		1 F

Numbers and Symbols (1)

No	Display character	Display segment pattern	HEX CODE	
			Upper two bits	Lower nibble
32	5		2	0
33	6		2	1
34	7		2	2
35	8		2	3
36	9		2	4
37			2	5
38			2	6
39			2	7

No	Display character	Display segment pattern	HEX CODE	
			Upper two bits	Lower nibble
40			2	8
41			2	9
42			2	A
43			2	B
44			2	C
45			2	D
46			2	E
47			2	F

Symbols (2)

No	Display character	Display segment pattern	HEX CODE
48			3 0
49			3 1
50			3 2
51			3 3
52			3 4
53	Lower-case character d		3 5
54	Lower-case character h		3 6
55	Lower-case character r		3 7

No	Display character	Display segment pattern	HEX CODE
56			3 8
57			3 9
58			3 A
59			3 B
60			3 C
61			3 D
62			3 E
63			3 F