

**SANYO**

No.5267

**2SJ417**

P-Channel Silicon MOSFET

Ultrahigh-Speed Switching Applications

**Features**

- Low ON-resistance.
- Ultrahigh-speed switching.
- 4V drive.

**Absolute Maximum Ratings at Ta = 25°C**

			unit
Drain-to-Source Voltage	V <sub>DSS</sub>	-30	V
Gate-to-Source Voltage	V <sub>GSS</sub>	±20	V
Drain Current(DC)	I <sub>D</sub>	-4	A
Drain Current(Pulse)	I <sub>DP</sub>	-16	A
Allowable Power Dissipation	P <sub>D</sub>	1	W
		Tc = 25°C	
Channel Temperature	Tch	20	W
Storage Temperature	Tstg	150	°C
		-55 to +150	°C

**Electrical Characteristics at Ta = 25°C**

			min	typ	max	unit
D-S Breakdown Voltage	V <sub>(BR)DSS</sub>	I <sub>D</sub> = -1mA, V <sub>GS</sub> = 0	-30			V
Zero-Gate Voltage Drain Current	I <sub>DSS</sub>	V <sub>DS</sub> = -30V, V <sub>GS</sub> = 0			-100	µA
Gate-to-Source Leakage Current	I <sub>GSS</sub>	V <sub>GS</sub> = ±16V, V <sub>DS</sub> = 0			±10	µA
Cutoff Voltage	V <sub>GS(off)</sub>	V <sub>DS</sub> = -10V, I <sub>D</sub> = -1mA	-1.0		-2.5	V
Forward Transfer Admittance	Y <sub>fs</sub>	V <sub>DS</sub> = -10V, I <sub>D</sub> = -2A	2	4		S
Static Drain-to-Source ON-State Resistance	R <sub>DSON</sub>	I <sub>D</sub> = -2A, V <sub>GS</sub> = -10V		120	160	mΩ
ON-State Resistance	R <sub>DSON</sub>	I <sub>D</sub> = -2A, V <sub>GS</sub> = -4V		210	290	mΩ
Input Capacitance	C <sub>iss</sub>	V <sub>DS</sub> = -10V, f = 1MHz		370		pF
Output Capacitance	C <sub>oss</sub>	V <sub>DS</sub> = -10V, f = 1MHz		230		pF
Reverse Transfer Capacitance	C <sub>rss</sub>	V <sub>DS</sub> = -10V, f = 1MHz		70		pF
Turn-ON Delay Time	t <sub>d(on)</sub>	See specified Test Circuit.		10		ns
Rise Time	t <sub>r</sub>	"		50		ns
Turn-OFF Delay Time	t <sub>d(off)</sub>	"		135		ns
Fall Time	t <sub>f</sub>	"		125		ns
Diode Forward Voltage	V <sub>SD</sub>	I <sub>S</sub> = -4A, V <sub>GS</sub> = 0	-1.0	-1.2		V

Marking : JJ

**Switching Time Test Circuit**

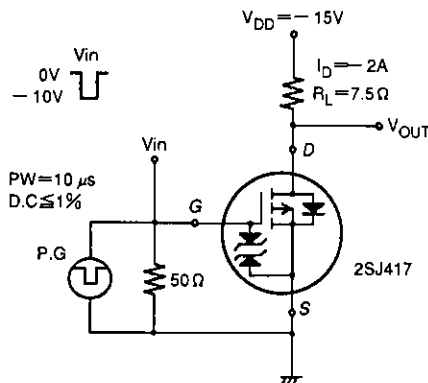

**Package Dimensions 2083B**

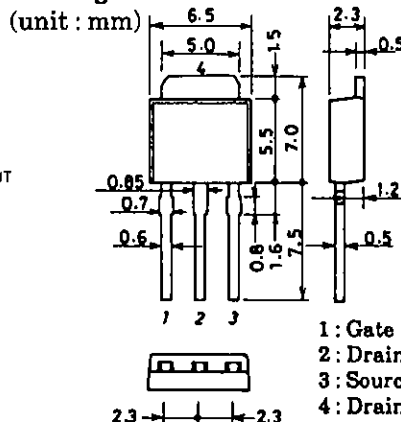

SANYO : TP

**Package Dimensions 2092B**

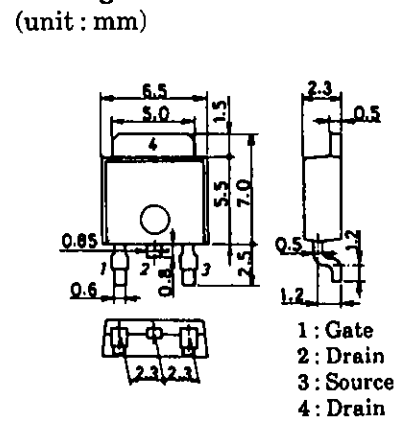

SANYO : TP-FA

**SANYO Electric Co., Ltd. Semiconductor Business Headquarters**

TOKYO OFFICE Tokyo Bldg., 1-10, 1 Chome, Ueno, Taito-ku, TOKYO, 110 JAPAN

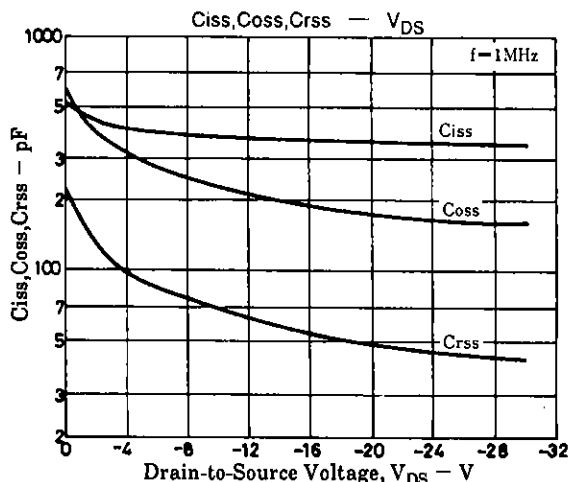
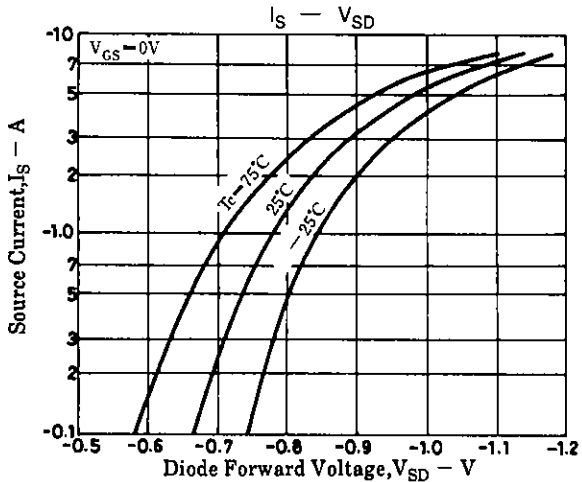
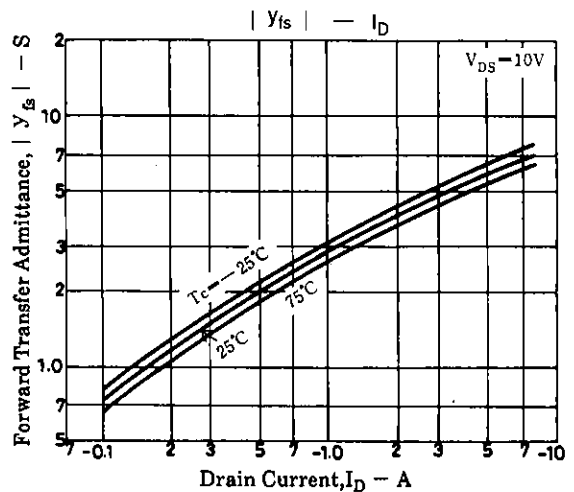
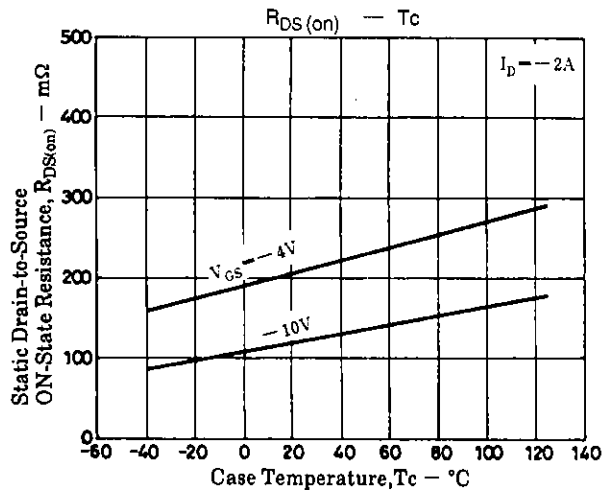
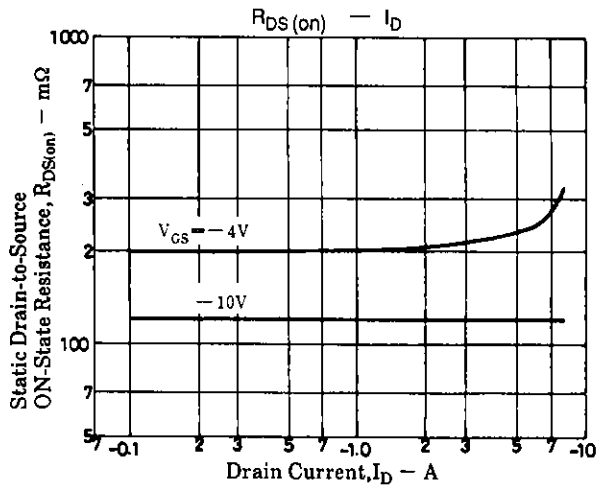
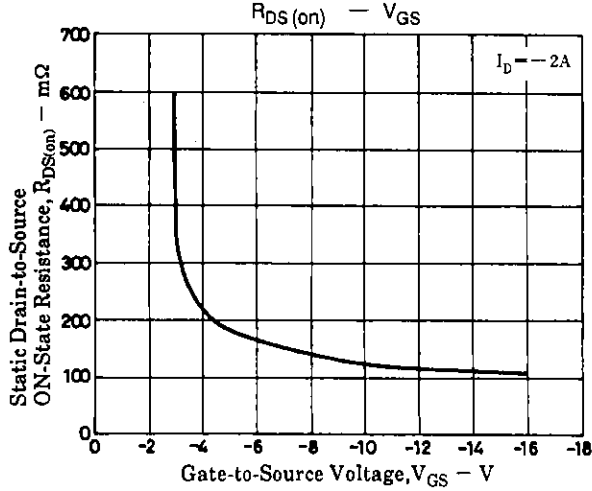
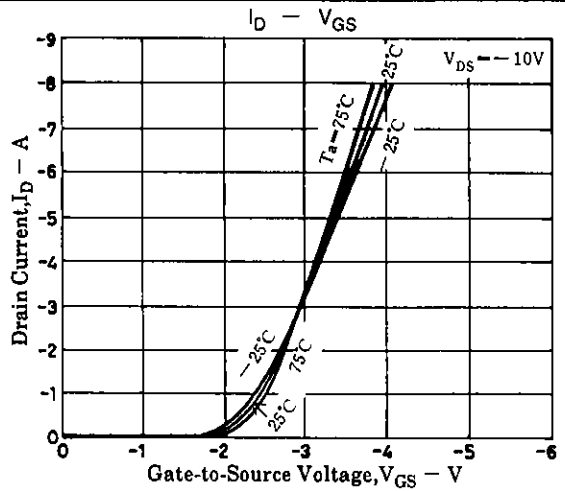
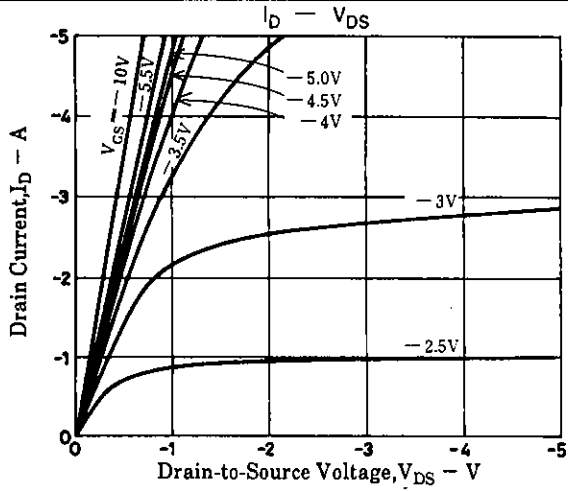

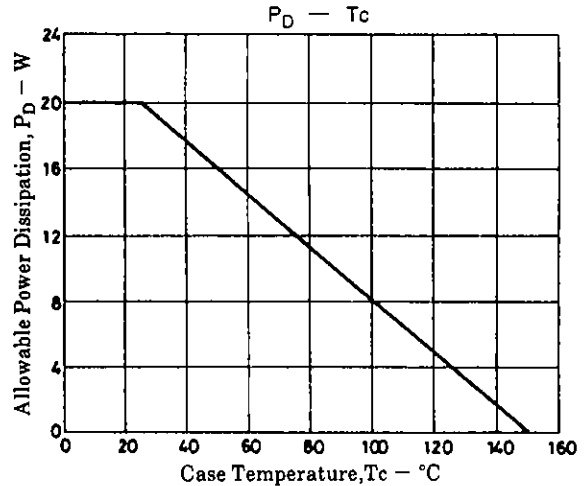
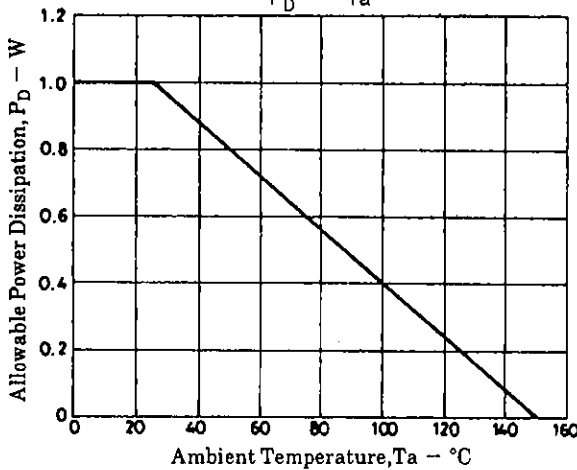
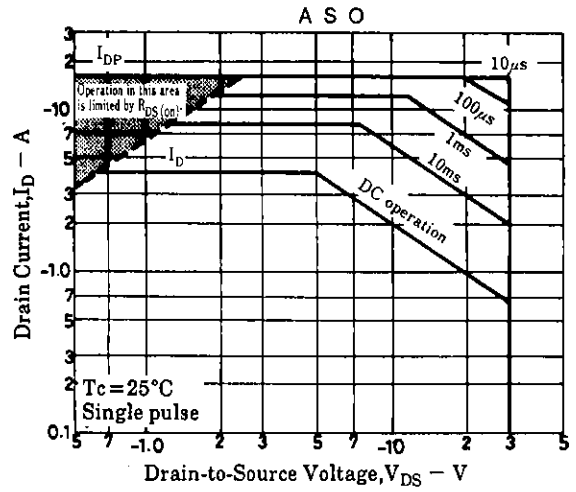
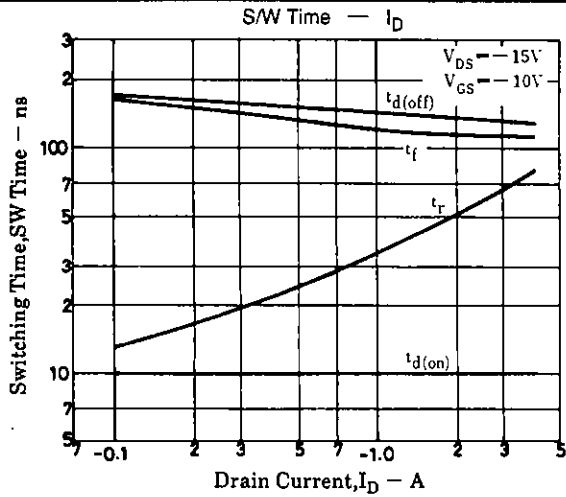

- No products described or contained herein are intended for use in surgical implants, life-support systems, aerospace equipment, nuclear power control systems, vehicles, disaster/crime-prevention equipment and the like, the failure of which may directly or indirectly cause injury, death or property loss.
- Anyone purchasing any products described or contained herein for an above-mentioned use shall:
  - ① Accept full responsibility and indemnify and defend SANYO ELECTRIC CO., LTD., its affiliates, subsidiaries and distributors and all their officers and employees, jointly and severally, against any and all claims and litigation and all damages, cost and expenses associated with such use;
  - ② Not impose any responsibility for any fault or negligence which may be cited in any such claim or litigation on SANYO ELECTRIC CO., LTD., its affiliates, subsidiaries and distributors or any of their officers and employees jointly or severally.
- Information (including circuit diagrams and circuit parameters) herein is for example only; it is not guaranteed for volume production. SANYO believes information herein is accurate and reliable, but no guarantees are made or implied regarding its use or any infringements of intellectual property rights or other rights of third parties.

This catalog provides information as of April, 1996. Specifications and information herein are subject to change without notice.