

SANYO	No.3769A	<h1 style="margin: 0;">2SK1468</h1> <p style="margin: 0;">N-Channel MOS Silicon FET</p> <p style="margin: 0;">Very High-Speed Switching Applications</p>
--------------	----------	--

Features

- Low ON resistance.
- Very high-speed switching.
- Low-voltage drive.

Absolute Maximum Ratings at Ta = 25°C

			unit
Drain to Source Voltage	V _{DSS}	30	V
Gate to Source Voltage	V _{GSS}	±15	V
Drain Current(DC)	I _D	4	A
Drain Current(Pulse)	I _{DP}	16	A
Allowable Power Dissipation	P _D	1.0	W
		T _c = 25°C	
		20	W
Channel Temperature	T _{ch}	150	°C
Storage Temperature	T _{stg}	-55 to +150	°C

Electrical Characteristics at Ta = 25°C

			min	typ	max	unit
D-S Breakdown Voltage	V _{(BR)DSS}	I _D = 1mA, V _{GS} = 0	30			V
G-S Breakdown Voltage	V _{(BR)GSS}	I _G = ±100μA, V _{DS} = 0	±15			V
Zero Gate Voltage Drain Current	I _{DSS}	V _{DS} = 30V, V _{GS} = 0			100	μA
Gate to Source Leakage Current	I _{GSS}	V _{GS} = ±12V, V _{DS} = 0			±10	μA
Cutoff Voltage	V _{GS(off)}	V _{DS} = 10V, I _D = 1mA	1.0		2.0	V
Forward Transfer Admittance	Y _{fs}	V _{DS} = 10V, I _D = 2A	2.5	4		S
Static Drain to Source on State Resistance	R _{DS(on)}	I _D = 2A, V _{GS} = 10V	0.085	0.12		Ω
	R _{DS(on)}	I _D = 2A, V _{GS} = 4V	0.12	0.17		Ω
Input Capacitance	C _{iss}	V _{DS} = 10V, f = 1MHz		400		pF
Output Capacitance	C _{oss}	V _{DS} = 10V, f = 1MHz		250		pF
Reverse Transfer Capacitance	C _{rss}	V _{DS} = 10V, f = 1MHz		90		pF
Turn-ON Delay Time	t _{d(on)}	See specified Test Circuit.		10		ns
Rise Time	t _r	∕		20		ns
Turn-OFF Delay Time	t _{d(off)}	∕		90		ns
Fall Time	t _f	∕		60		ns
Diode Forward Voltage	V _{SD}	I _S = 4A, V _{GS} = 0	1.0	1.5		V

Switching Time Test Circuit

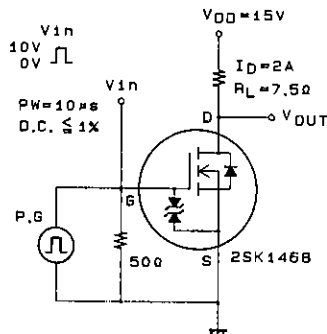

Package Dimensions 2083A

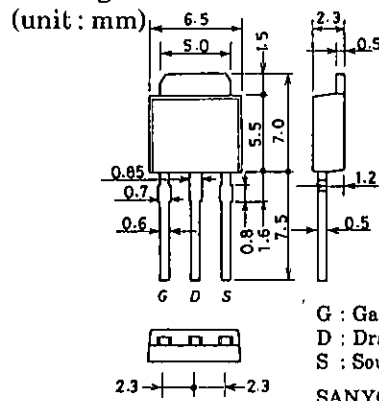

Package Dimensions 2092A

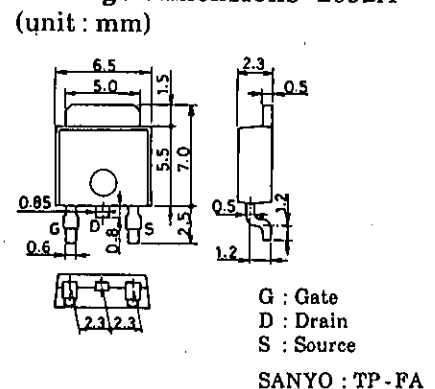

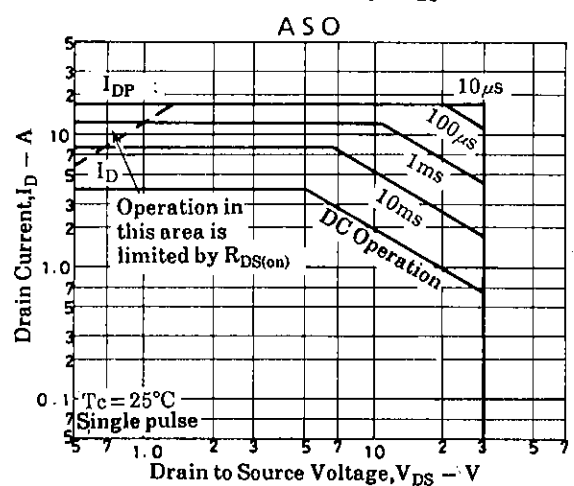
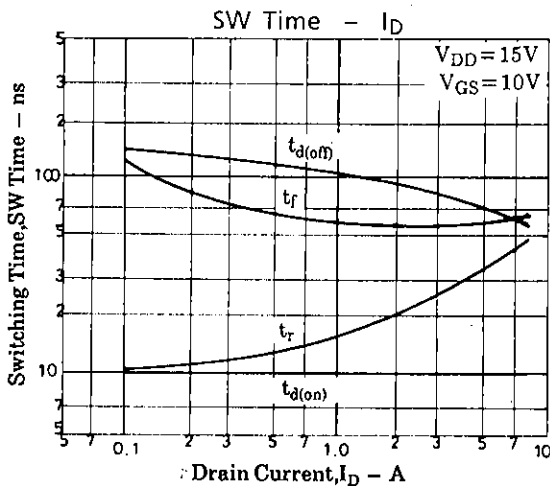
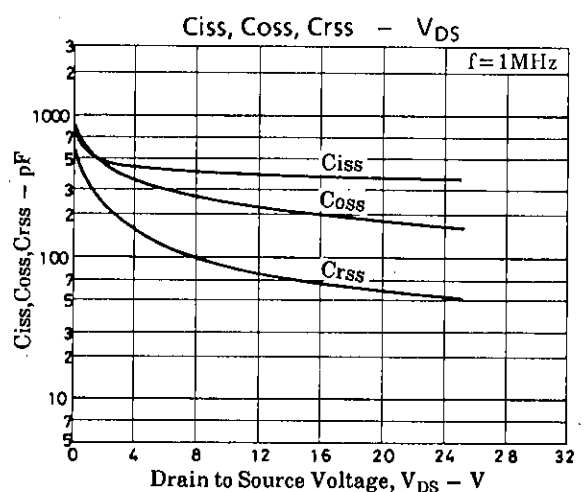
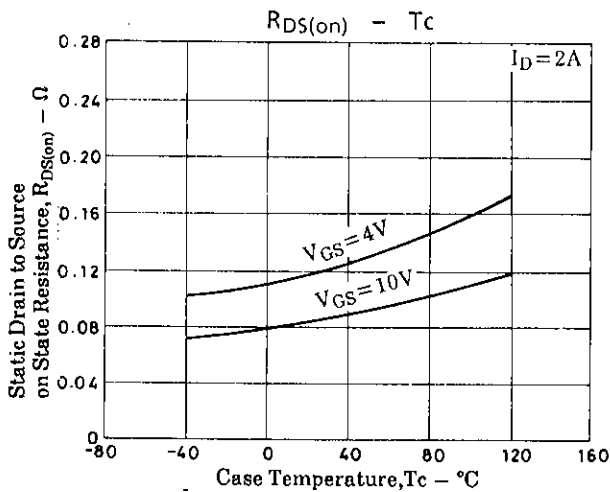
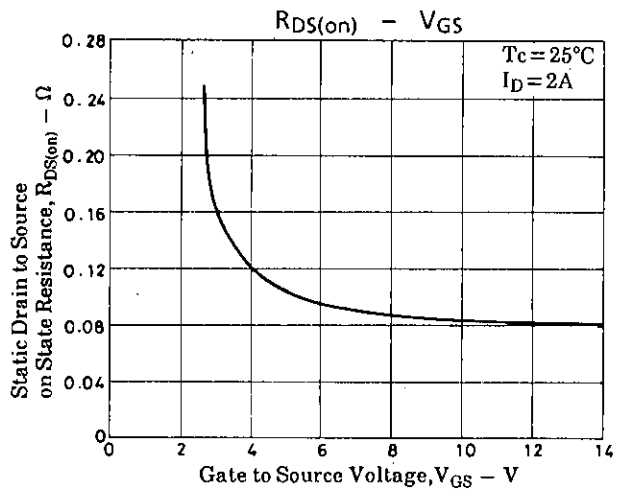
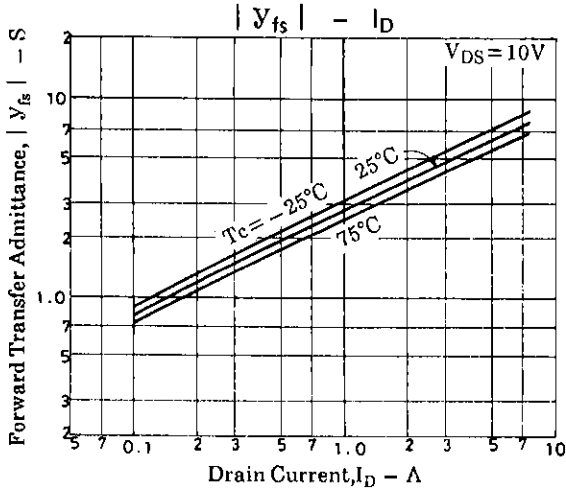
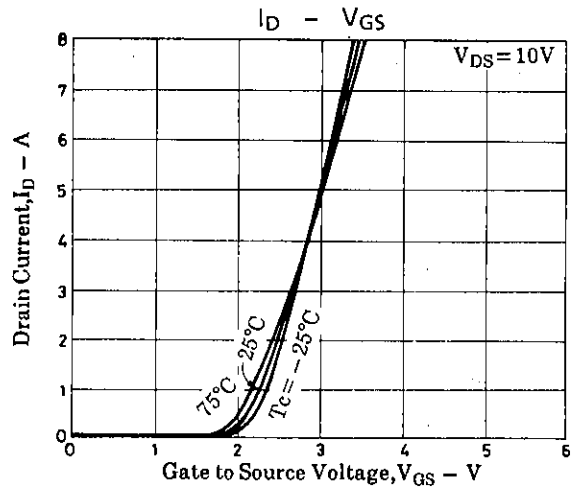
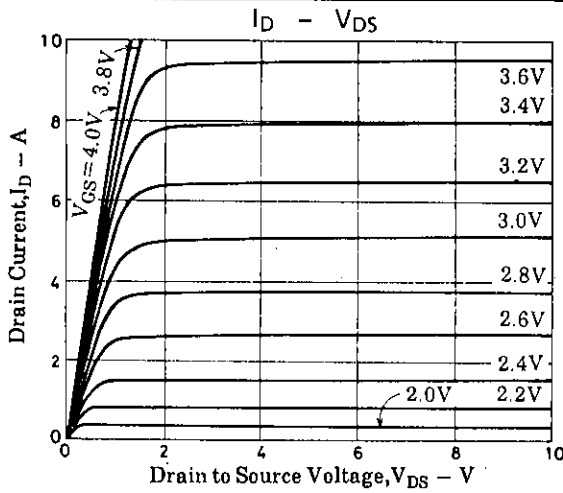

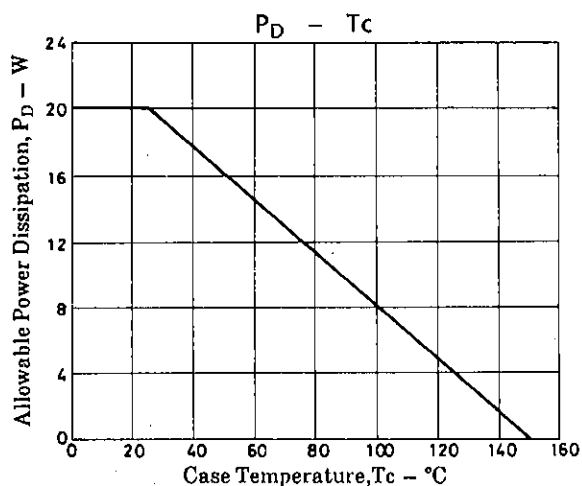
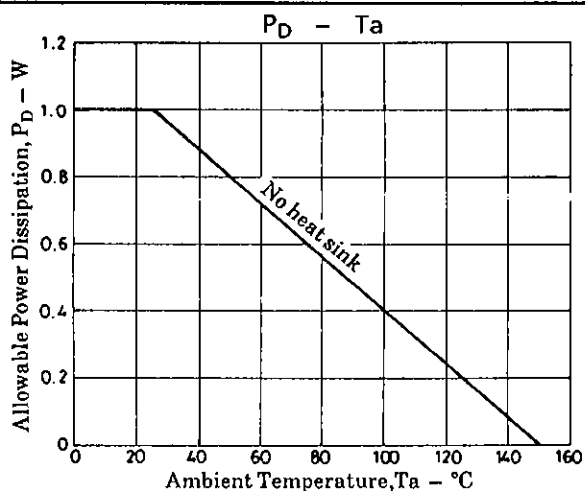

- No products described or contained herein are intended for use in surgical implants, life-support systems, aerospace equipment, nuclear power control systems, vehicles, disaster/crime-prevention equipment and the like, the failure of which may directly or indirectly cause injury, death or property loss.
- Anyone purchasing any products described or contained herein for an above-mentioned use shall:
 - ① Accept full responsibility and indemnify and defend SANYO ELECTRIC CO., LTD., its affiliates, subsidiaries and distributors and all their officers and employees, jointly and severally, against any and all claims and litigation and all damages, cost and expenses associated with such use:
 - ② Not impose any responsibility for any fault or negligence which may be cited in any such claim or litigation on SANYO ELECTRIC CO., LTD., its affiliates, subsidiaries and distributors or any of their officers and employees jointly or severally.
- Information (including circuit diagrams and circuit parameters) herein is for example only; it is not guaranteed for volume production. SANYO believes information herein is accurate and reliable, but no guarantees are made or implied regarding its use or any infringements of intellectual property rights or other rights of third parties.