



No.4423A

3SK263

N-Channel MOS Silicon FET (Dual Gate)

FM Tuner, VHF Tuner,
High-Frequency Amp Applications

Features

- Enhancement type.
- Small noise figure.
- Small cross modulation.

Absolute Maximum Ratings at Ta = 25°C

			unit
Drain-to-Source Voltage	V _{DS}	15	V
Gate1-to-Source Voltage	V _{G1S}	±8	V
Gate2-to-Source Voltage	V _{G2S}	±8	V
Drain Current	I _D	30	mA
Allowable Power Dissipation	P _D	200	mW
Channel Temperature	T _{ch}	125	°C
Storage Temperature	T _{stg}	-55 to +125	°C

Electrical Characteristics at Ta = 25°C

			min	typ	max	unit
Drain-to-Source Voltage	V _{DS}	V _{G1S} =0V, V _{G2S} =0V, I _D =100μA	15			V
Gate1-to-Source Cutoff Voltage	V _{G1S(off)}	V _{DS} =6V, V _{G2S} =4V, I _D =100μA	0	0.7	1.3	V
Gate2-to-Source Cutoff Voltage	V _{G2S(off)}	V _{DS} =6V, V _{G1S} =3V, I _D =100μA	0.1	0.9	1.6	V
Gate1 Cutoff Current	I _{G1SS}	V _{G1S} =±6V, V _{G2S} =V _{DS} =0V			±50	nA
Gate2 Cutoff Current	I _{G2SS}	V _{G2S} =±6V, V _{G1S} =V _{DS} =0V			±50	nA
Drain Current	I _{DSX}	V _{DS} =6V, V _{G1S} =1.5V, V _{G2S} =4V	2.5*		24*	mA
Forward Transfer Admittance	Y _{fs}	V _{DS} =6V, I _D =10mA, V _{G2S} =4V, f=1kHz		14		mS
Input Capacitance	C _{iss}	V _{DS} =6V, f=1MHz		2.7		pF
Reverse Transfer Capacitance	C _{rss}	V _{G1S} =0V, V _{G2S} =4V		0.015	0.03	pF
Power Gain	PG	V _{DS} =6V, I _D =10mA	18	21		dB
Noise Figure	NF	V _{G2S} =4V, f=200MHz		1.1	2.2	dB

* : The 3SK263 is classified by I_{DSX} as follows : (unit : mA)

2.5	4	6.0	5.0	5	12.0	10.0	6	24.0
-----	---	-----	-----	---	------	------	---	------

Marking : RJ

I_{DSX} rank : 4, 5, 6

PG, NF Test Circuit

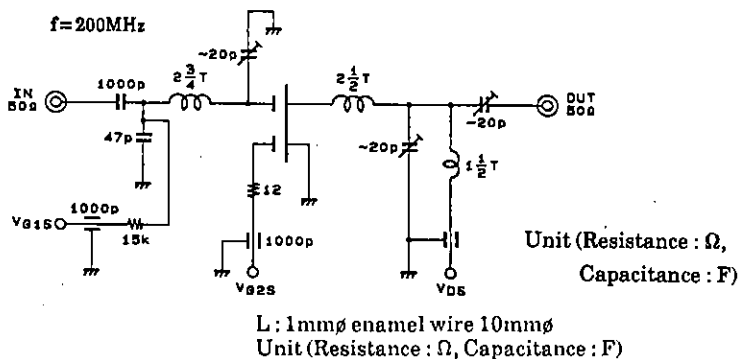

Package Dimensions 2096A
(unit : mm)

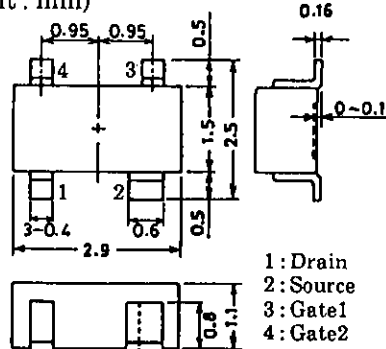

SANYO : CP4

SANYO Electric Co., Ltd. Semiconductor Business Headquarters
TOKYO OFFICE Tokyo Bldg., 1-10, 1 Chome, Ueno, Taito-ku, TOKYO, 110 JAPAN

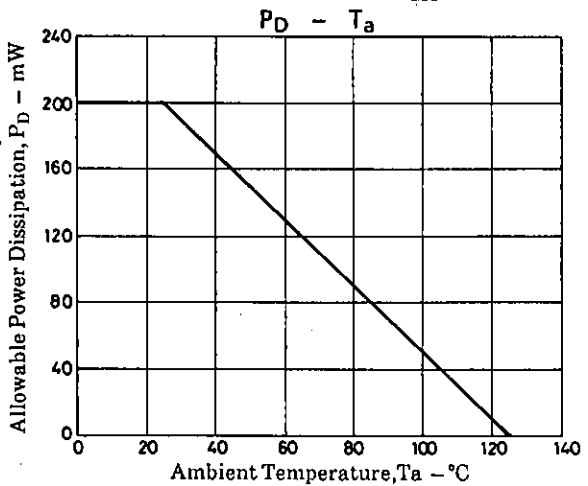
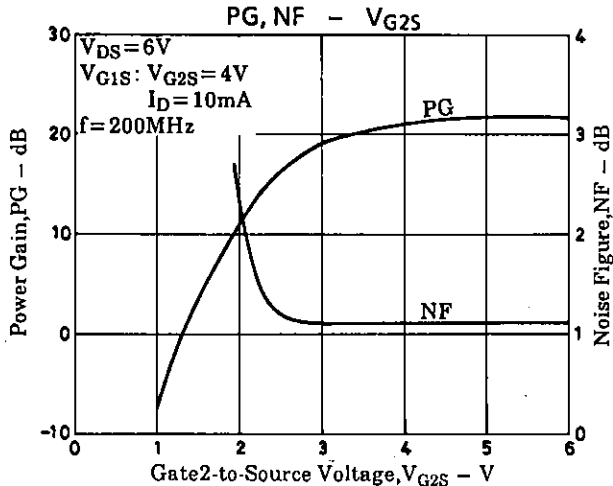
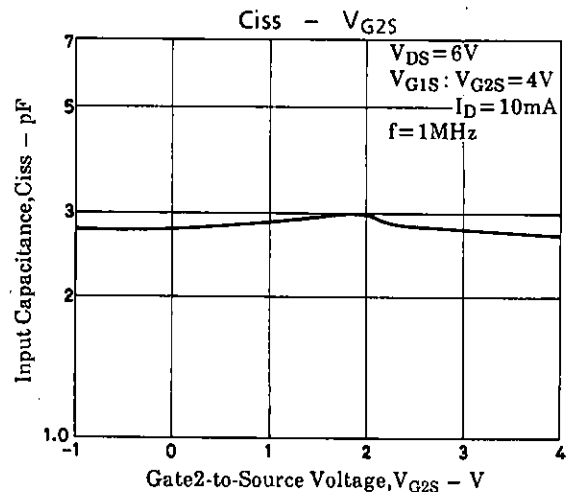
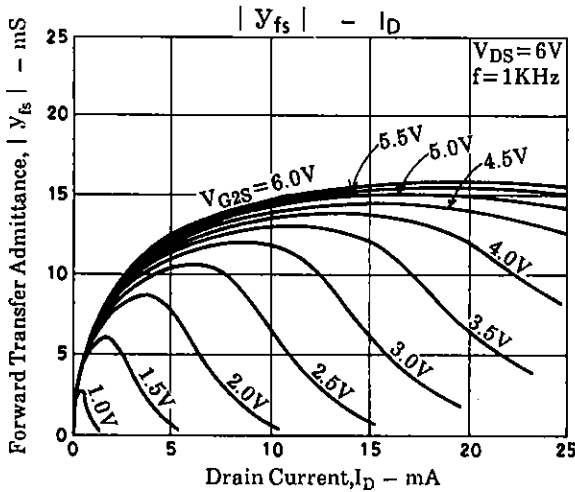
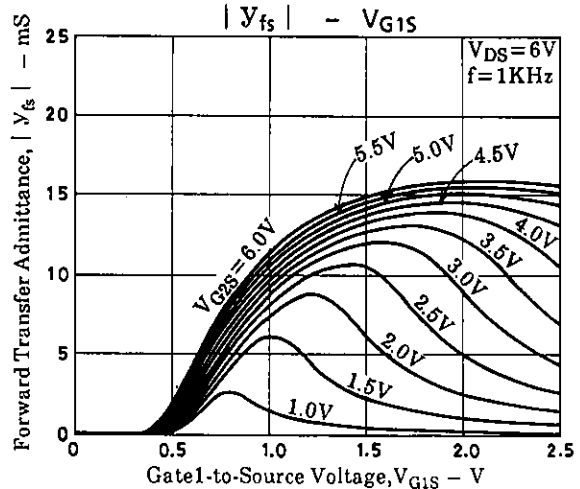
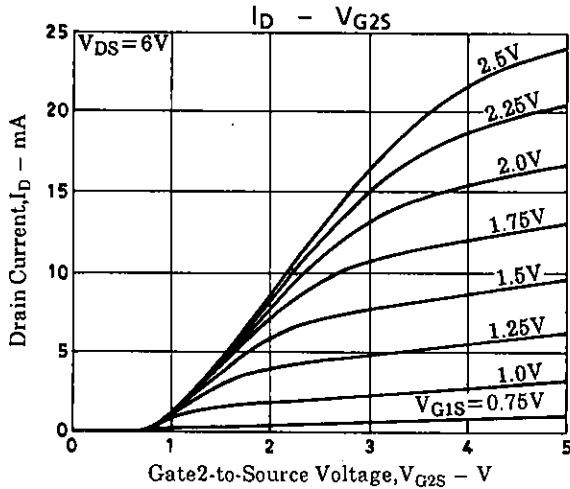
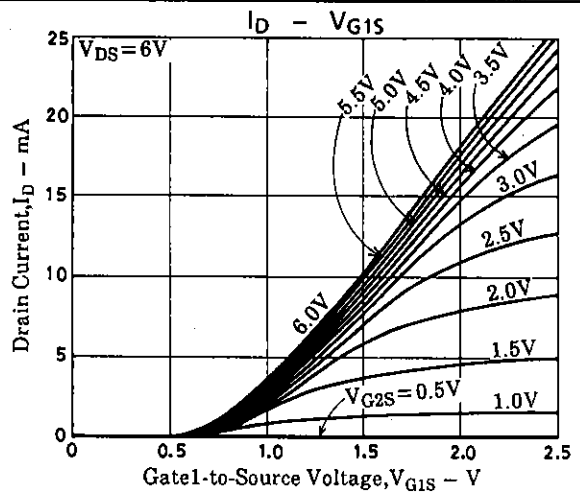
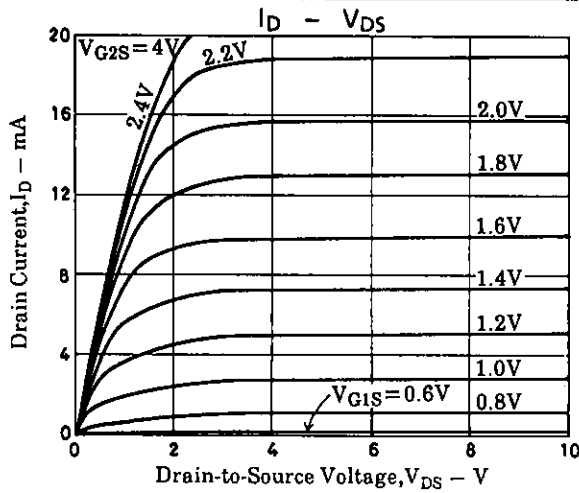

- No products described or contained herein are intended for use in surgical implants, life-support systems, aerospace equipment, nuclear power control systems, vehicles, disaster/crime-prevention equipment and the like, the failure of which may directly or indirectly cause injury, death or property loss.
- Anyone purchasing any products described or contained herein for an above-mentioned use shall:
 - ① Accept full responsibility and indemnify and defend SANYO ELECTRIC CO., LTD., its affiliates, subsidiaries and distributors and all their officers and employees, jointly and severally, against any and all claims and litigation and all damages, cost and expenses associated with such use;
 - ② Not impose any responsibility for any fault or negligence which may be cited in any such claim or litigation on SANYO ELECTRIC CO., LTD., its affiliates, subsidiaries and distributors or any of their officers and employees jointly or severally.
- Information (including circuit diagrams and circuit parameters) herein is for example only; it is not guaranteed for volume production. SANYO believes information herein is accurate and reliable, but no guarantees are made or implied regarding its use or any infringements of intellectual property rights or other rights of third parties.

This catalog provides information as of **February**, 1996. Specifications and information herein are subject to change without notice.