



No.5251

2SK2406

N-Channel Silicon MOSFET

Ultrahigh-Speed Switching,
Motor Driver Applications

Features

- Low ON-resistance.
- Ultrahigh-speed switching.
- High-speed diode.

Absolute Maximum Ratings at Ta = 25°C

			unit
Drain-to-Source Voltage	V _{DSS}	450	V
Gate-to-Source Voltage	V _{GSS}	±30	V
Drain Current(DC)	I _D	1	A
Drain Current(Pulse)	I _{DP}	PW ≤ 10μs, duty cycle ≤ 1%	4 A
Allowable Power Dissipation	P _D	T _c = 25°C	1 W
			30 W
Channel Temperature	T _{ch}		150 °C
Storage Temperature	T _{stg}		-55 to +150 °C

Electrical Characteristics at Ta = 25°C

			min	typ	max	unit
D-S Breakdown Voltage	V _{(BR)DSS}	I _D = 1mA, V _{GS} = 0	450			V
Zero-Gate Voltage	I _{DSS}	V _{DS} = 450V, V _{GS} = 0			1	mA
Drain Current						
Gate-to-Source Leakage Current	I _{GSS}	V _{GS} = ±30V, V _{DS} = 0			±100	nA
Cutoff Voltage	V _{GS(off)}	V _{DS} = 10V, I _D = 1mA	2.0		3.0	V
Forward Transfer Admittance	Y _{fs}	V _{DS} = 10V, I _D = 0.5A	0.4	0.8		S
Static Drain-to-Source ON-State Resistance	R _{DS(on)}	I _D = 0.5A, V _{GS} = 10V		3.5	4.5	Ω
Input Capacitance	C _{iss}	V _{DS} = 20V, f = 1MHz		300		pF
Output Capacitance	C _{oss}	V _{DS} = 20V, f = 1MHz		40		pF
Reverse Transfer Capacitance	C _{rss}	V _{DS} = 20V, f = 1MHz		8		pF
Turn-ON Delay Time	t _{d(on)}	See specified Test Circuit.		10		ns
Rise Time	t _r	"		9		ns
Turn-OFF Delay Time	t _{d(off)}	"		60		ns
Fall Time	t _f	"		50		ns
Diode Forward Voltage	V _{SD}	I _S = 1A, V _{GS} = 0	0.8	1.2		V
Diode Reverse Time	t _{rr}	I _S = 1A, di/dt = 100A/μs	80	120		ns

Switching Time Test Circuit

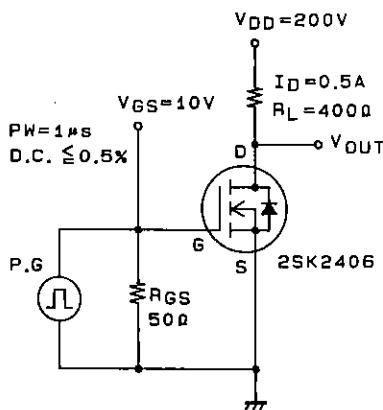

Package Dimensions 2083B

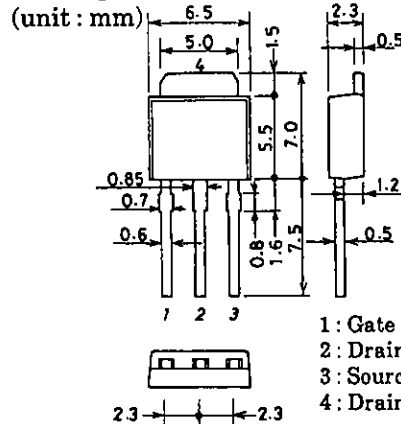

SANYO : TP

Package Dimensions 2092B

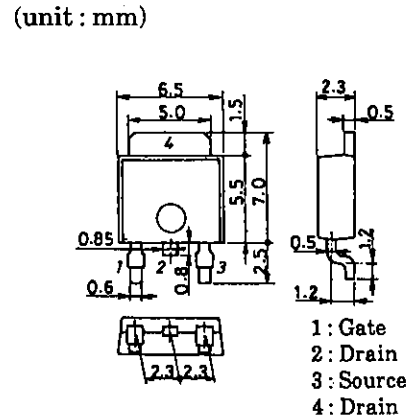

SANYO : TP-FA

SANYO Electric Co., Ltd. Semiconductor Business Headquarters
TOKYO OFFICE Tokyo Bldg., 1-10, 1 Chome, Ueno, Taito-ku, TOKYO, 110 JAPAN

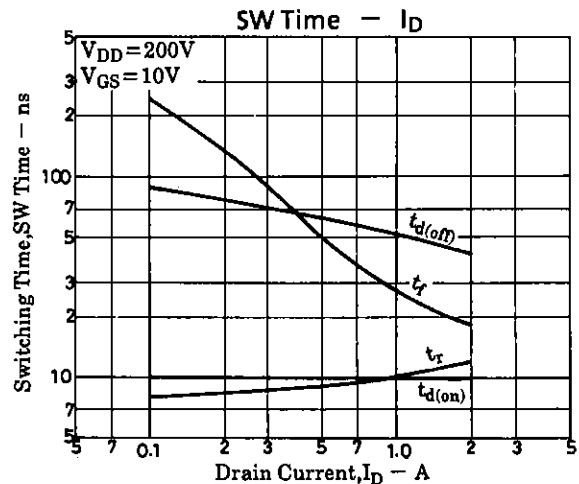
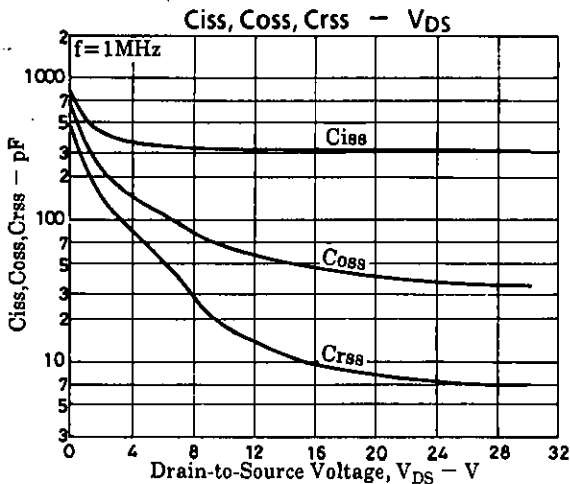
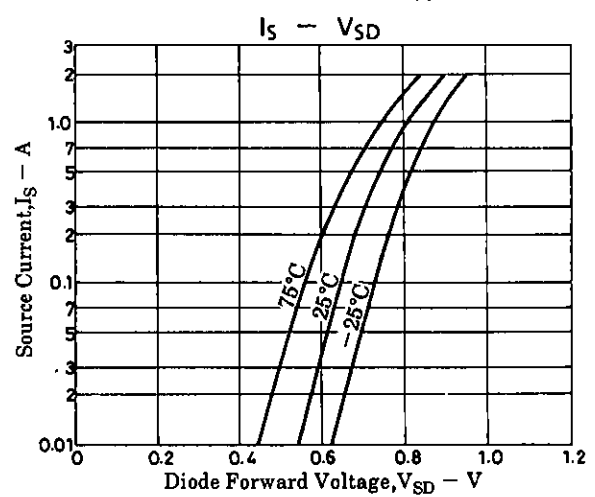
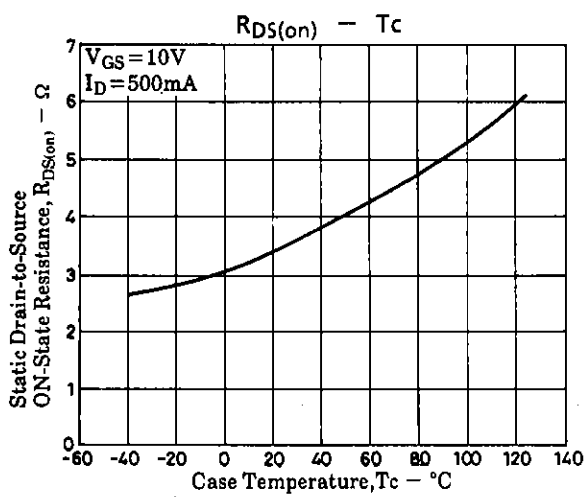
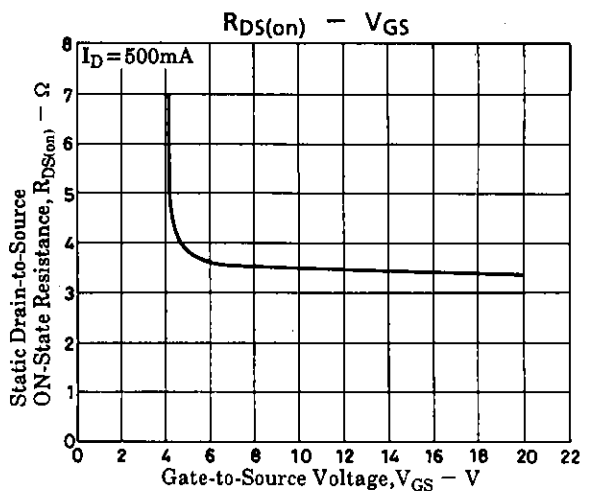
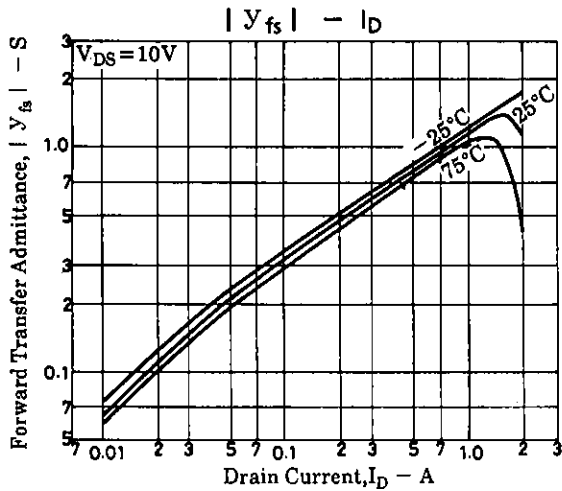
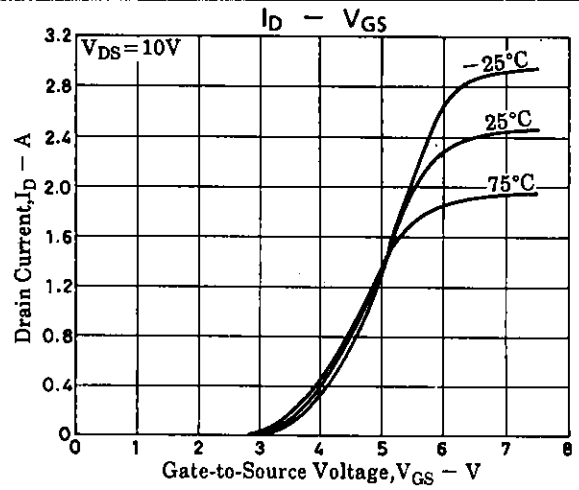
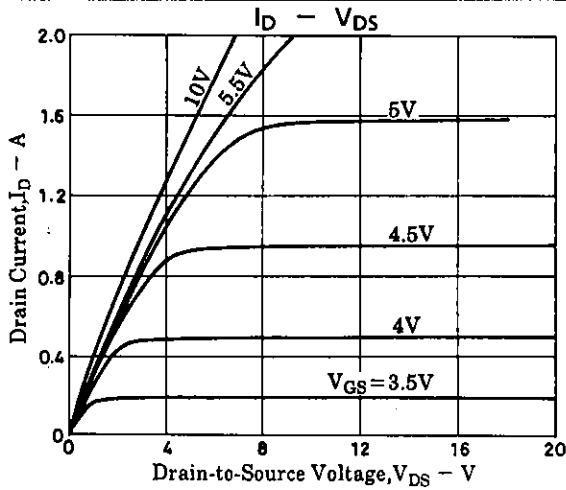

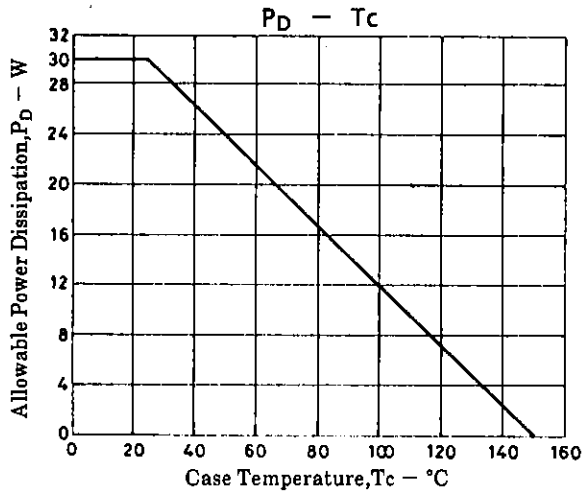
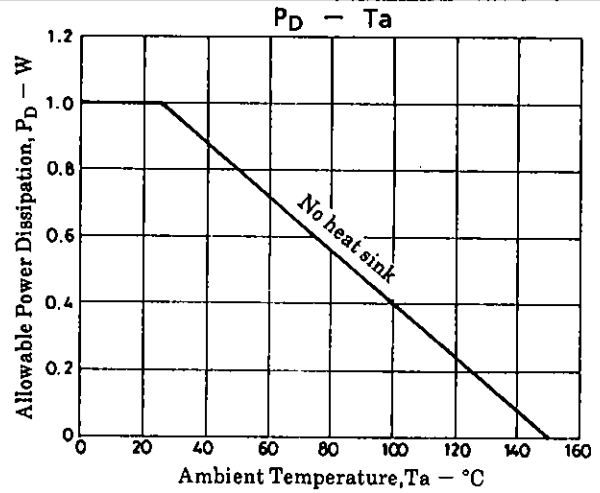
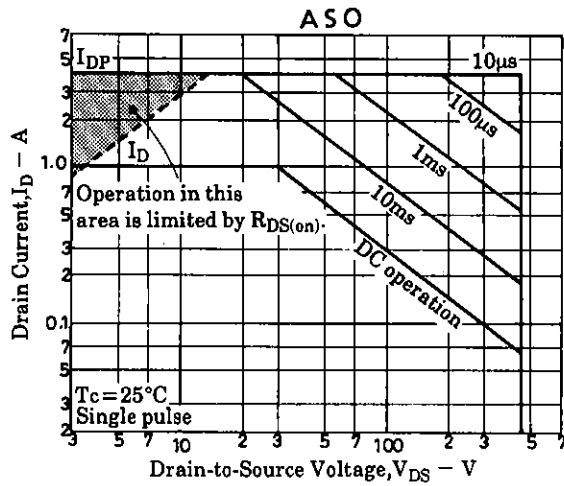

- No products described or contained herein are intended for use in surgical implants, life-support systems, aerospace equipment, nuclear power control systems, vehicles, disaster/crime-prevention equipment and the like, the failure of which may directly or indirectly cause injury, death or property loss.
- Anyone purchasing any products described or contained herein for an above-mentioned use shall:
 - ① Accept full responsibility and indemnify and defend SANYO ELECTRIC CO., LTD., its affiliates, subsidiaries and distributors and all their officers and employees, jointly and severally, against any and all claims and litigation and all damages, cost and expenses associated with such use;
 - ② Not impose any responsibility for any fault or negligence which may be cited in any such claim or litigation on SANYO ELECTRIC CO., LTD., its affiliates, subsidiaries and distributors or any of their officers and employees jointly or severally.
- Information (including circuit diagrams and circuit parameters) herein is for example only; it is not guaranteed for volume production. SANYO believes information herein is accurate and reliable, but no guarantees are made or implied regarding its use or any infringements of intellectual property rights or other rights of third parties.

This catalog provides information as of April, 1996. Specifications and information herein are subject to change without notice.