

SANYO	No.4617	<h1 style="margin: 0;">2SK2083</h1> <p style="margin: 0;">N-Channel MOS Silicon FET</p> <p style="margin: 0;">Very High-Speed Switching Applications</p>
--------------	---------	--

Features

- Low ON resistance
- Very high-speed switching
- Micaless package facilitating mounting

Absolute Maximum Ratings at Ta = 25°C

			unit
Drain-to-Source Voltage	V_{DSS}	900	V
Gate-to-Source Voltage	V_{GSS}	± 30	V
Drain Current(DC)	I_D	5	A
Drain Current(Pulse)	I_{DP}	$PW \leq 10\mu s, \text{ duty cycle} \leq 1\%$	10 A
Allowable Power Dissipation	P_D	$T_c = 25^\circ C$	70 W
			1.65 W
Channel Temperature	T_{ch}	150	$^\circ C$
Storage Temperature	T_{stg}	-55 to +150	$^\circ C$

Electrical Characteristics at Ta = 25°C

			min	typ	max	unit
D-S Breakdown Voltage	$V_{(BR)DSS}$	$I_D = 1mA, V_{GS} = 0$	900			V
Zero-Gate Voltage Drain Current	I_{DSS}	$V_{DS} = 900V, V_{GS} = 0$			1.0	mA
Gate-to-Source Leakage Current	I_{GSS}	$V_{GS} = \pm 30V, V_{DS} = 0$			± 100	nA
Cutoff Voltage	$V_{GS(off)}$	$V_{DS} = 10V, I_D = 1mA$	2.0		3.0	V
Forward Transfer Admittance	$ Y_{fs} $	$V_{DS} = 20V, I_D = 2A$	1.0	2.0		S
Static Drain-to-Source On-state Resistance	$R_{DS(on)}$	$I_D = 2A, V_{GS} = 10V$		2.8	3.6	Ω
Input Capacitance	C_{iss}	$V_{DS} = 20V, f = 1MHz$		700		pF
Output Capacitance	C_{oss}	$V_{DS} = 20V, f = 1MHz$		300		pF
Reverse Transfer Capacitance	C_{rss}	$V_{DS} = 20V, f = 1MHz$		170		pF
Turn-ON Delay Time	$t_{d(on)}$	$I_D = 2A, V_{GS} = 10V$ $V_{DD} = 200V, R_{GS} = 50\Omega$		15		ns
Rise Time	t_r		35	ns		
Turn-OFF Delay Time	$t_{d(off)}$		200	ns		
Fall Time	t_f		65	ns		
Diode Forward Voltage	V_{SD}		$I_S = 5A, V_{GS} = 0$			1.8

Switching Time Test Circuit

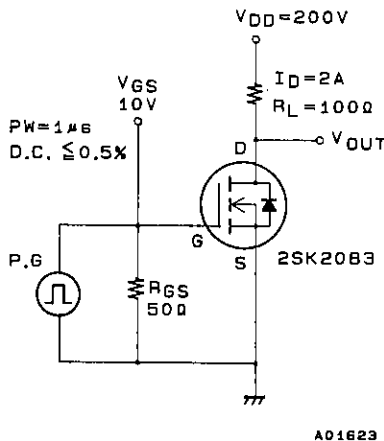

Package Dimensions 2090A (unit: mm)

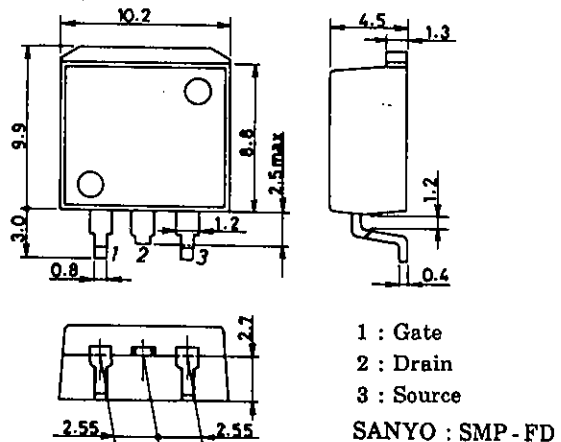

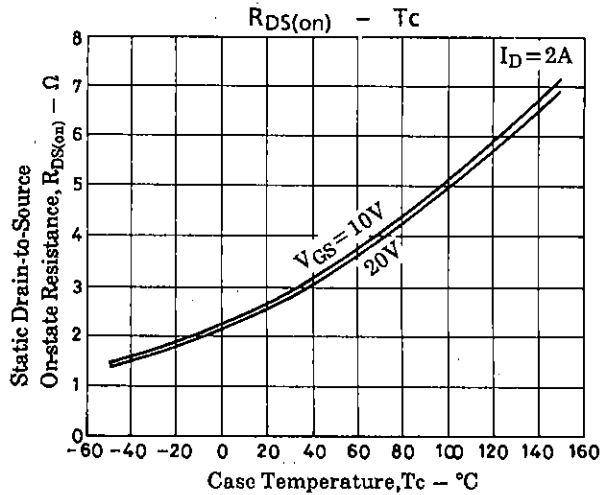
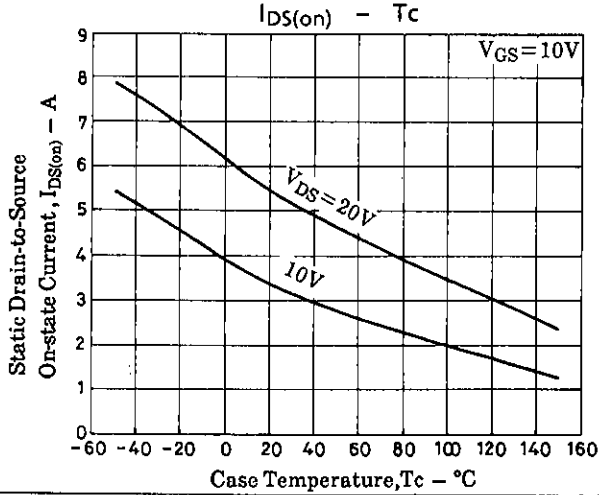
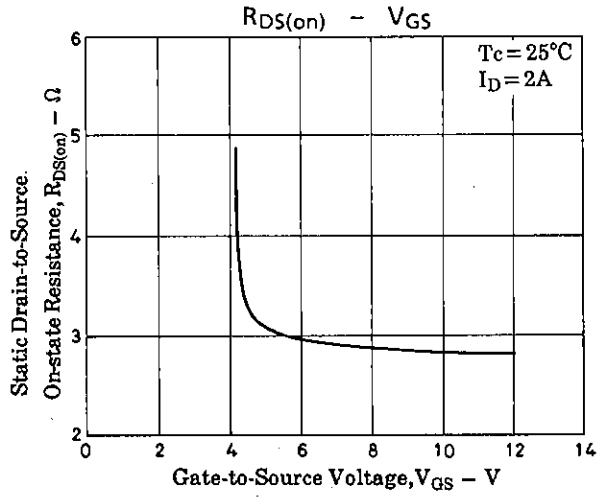
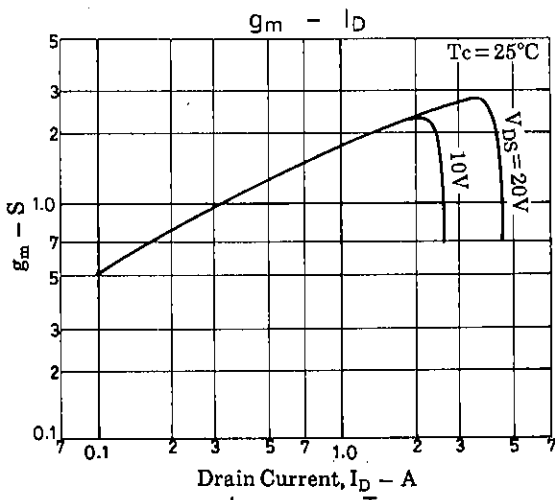
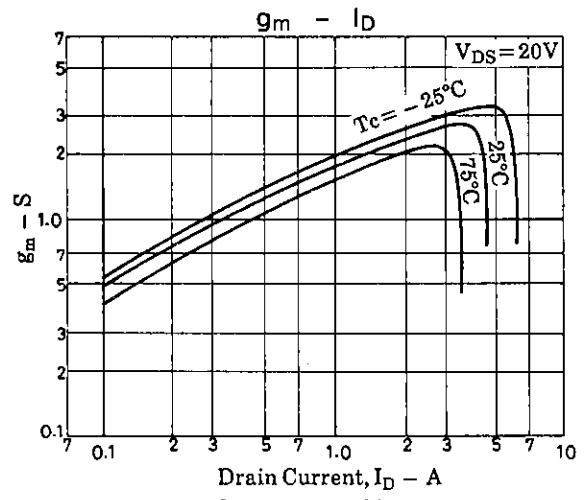
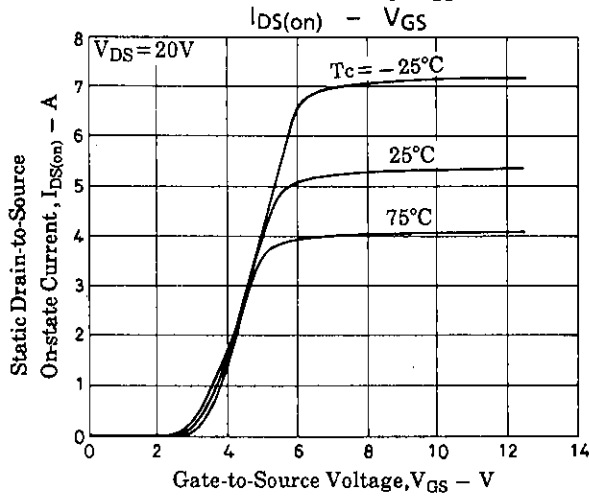
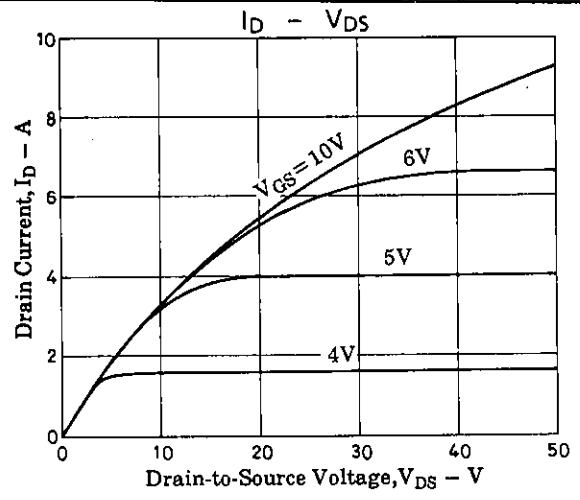
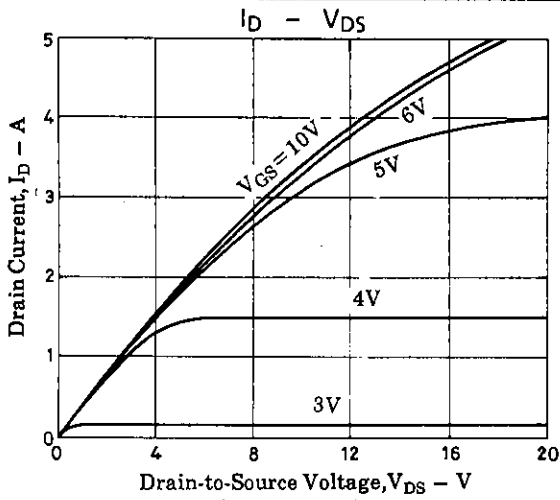

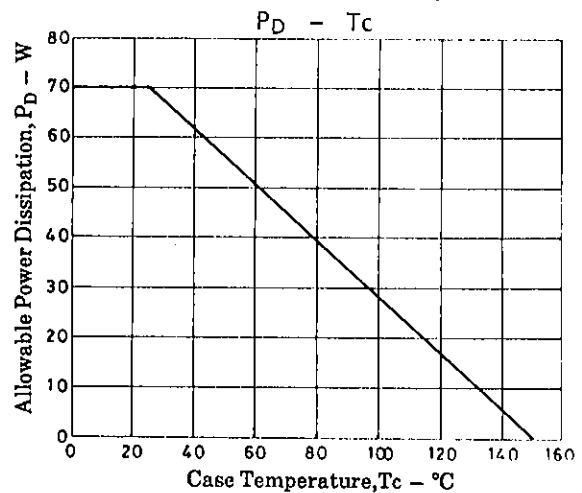
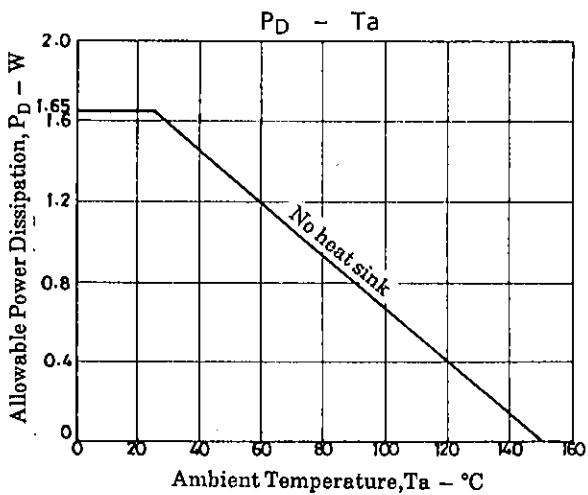
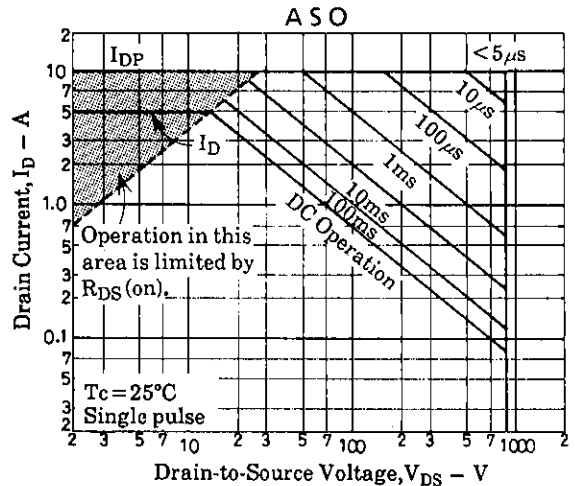
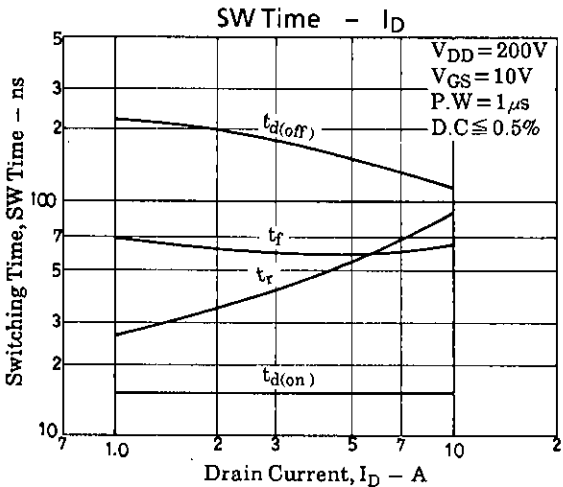
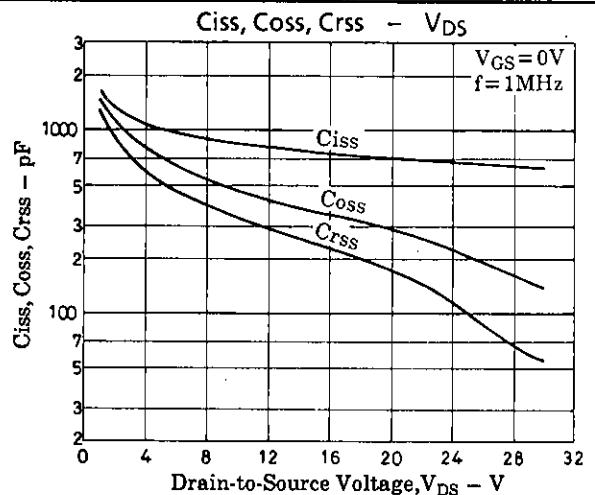
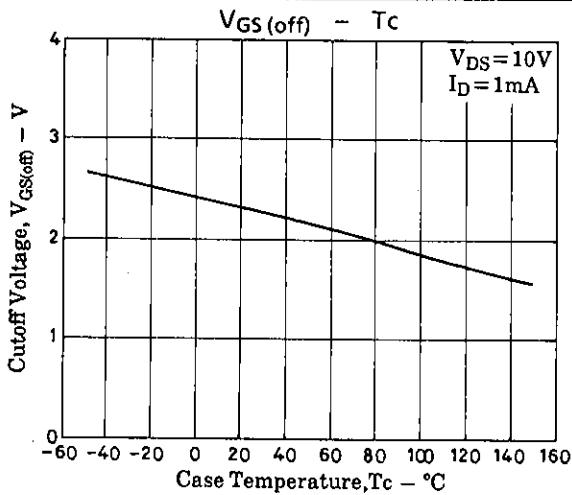

■ No products described or contained herein are intended for use in surgical implants, life-support systems, aerospace equipment, nuclear power control systems, vehicles, disaster/crime-prevention equipment and the like, the failure of which may directly or indirectly cause injury, death or property loss.

■ Anyone purchasing any products described or contained herein for an above-mentioned use shall:

- ① Accept full responsibility and indemnify and defend SANYO ELECTRIC CO., LTD., its affiliates, subsidiaries and distributors and all their officers and employees, jointly and severally, against any and all claims and litigation and all damages, cost and expenses associated with such use;
- ② Not impose any responsibility for any fault or negligence which may be cited in any such claim or litigation on SANYO ELECTRIC CO., LTD., its affiliates, subsidiaries and distributors or any of their officers and employees jointly or severally.

■ Information (including circuit diagrams and circuit parameters) herein is for example only; it is not guaranteed for volume production. SANYO believes information herein is accurate and reliable, but no guarantees are made or implied regarding its use or any infringements of intellectual property rights or other rights of third parties.