

| | | |
|------------------------------|---------|------------------------|
| SANYO | No.5683 | SB05-18V |
| | | Schottky Barrier Diode |
| 180V, 500mA Rectifier | | |

Applications

- High frequency rectification (switching regulators, converters, choppers).

Features

- Low forward voltage (V_F max = 0.85V).
- Fast reverse recovery time (t_{rr} max = 20ns).
- Low switching noise.
- Low leakage current and high reliability due to highly reliable planar structure.

Absolute Maximum Ratings at $T_a = 25^\circ\text{C}$

| | | | unit |
|---|-----------|-------------|------------------|
| Repetitive Peak Reverse Voltage | V_{RRM} | 180 | V |
| Non-repetitive Peak Reverse Surge Voltage | V_{RSM} | 190 | V |
| Average Output Current | I_O | 500 | mA |
| Surge Forward Current | I_{FSM} | 10 | A |
| Junction Temperature | T_j | 125 | $^\circ\text{C}$ |
| Storage Temperature | T_{stg} | -55 to +125 | $^\circ\text{C}$ |

*50Hz resistive load, $T_a = 26^\circ\text{C}$
50Hz sine wave, 1 cycle*

Electrical Characteristics at $T_a = 25^\circ\text{C}$

| | | | min | typ | max | unit |
|---------------------------|---------------|-------------------------------------|-----|-----|------|--------------------|
| Reverse Voltage | V_R | $I_R = 500\mu\text{A}$ | 180 | | | V |
| Forward Voltage | V_F | $I_F = 500\text{mA}$ | | | 0.85 | V |
| Reverse Current | I_R | $V_R = 90\text{V}$ | | | 60 | μA |
| Interterminal Capacitance | C | $V_R = 10\text{V}, f = 1\text{MHz}$ | | 45 | | pF |
| Reverse Recovery Time | t_{rr} | $I_F = I_R = 100\text{mA}$ | | | 20 | ns |
| Thermal Resistance | $R_{th\ j-a}$ | See specified Test Circuit. | | | 110 | $^\circ\text{C/W}$ |

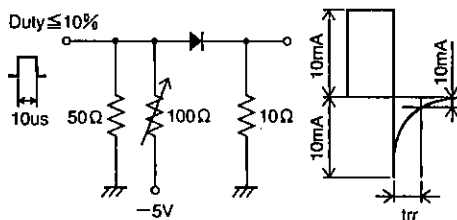
 t_{rr} Test Circuit**Package Dimensions 1289**

(unit : mm)

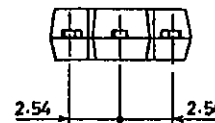
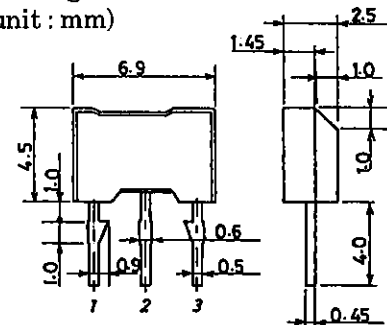

1: Anode
2: Cathode
3: No Contact

SANYO : NMP

SANYO Electric Co., Ltd. Semiconductor Business Headquarters

TOKYO OFFICE Tokyo Bldg., 1-10, 1 Chome, Ueno, Taito-ku, TOKYO, 110 JAPAN

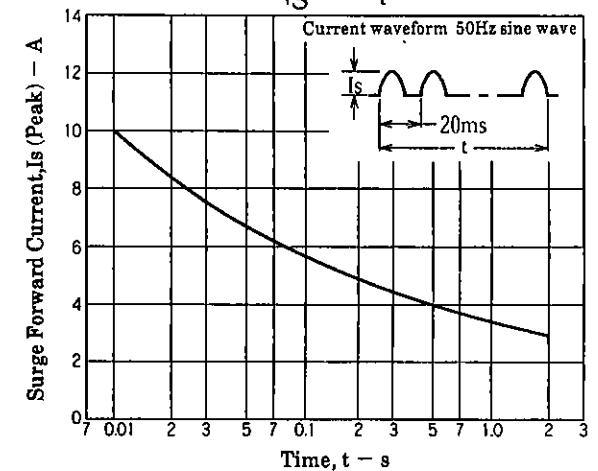
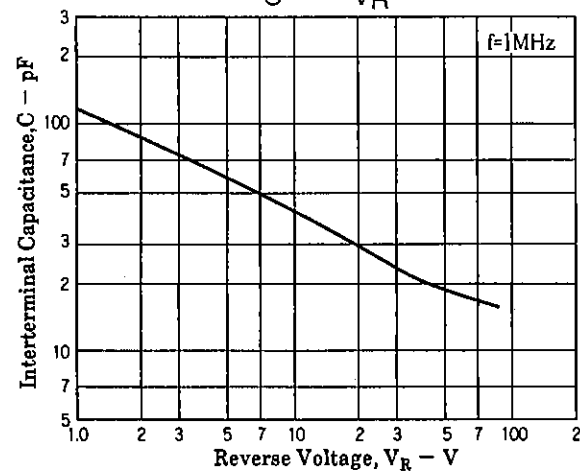
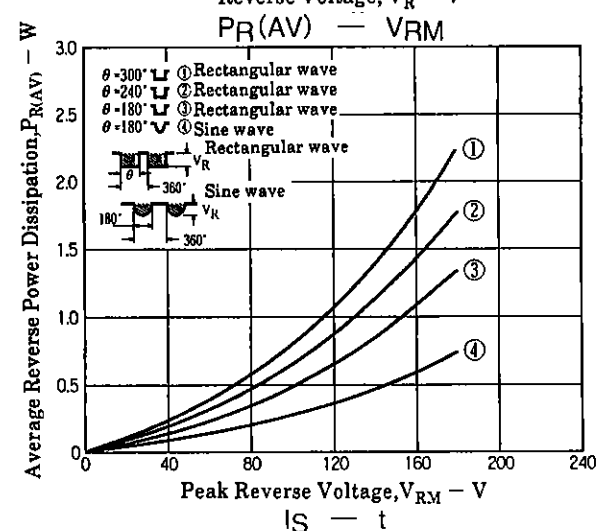
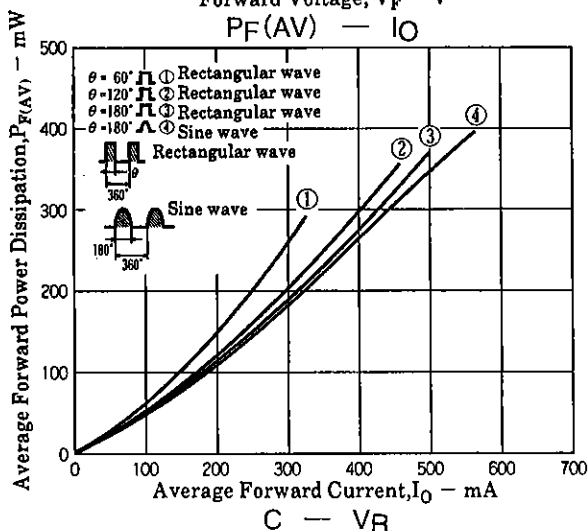
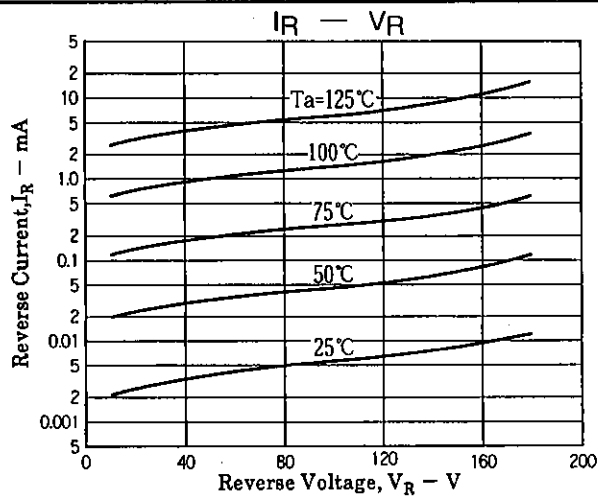
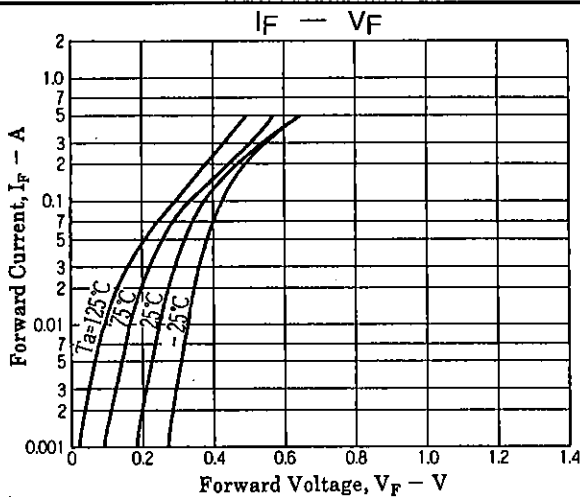

■ No products described or contained herein are intended for use in surgical implants, life-support systems, aerospace equipment, nuclear power control systems, vehicles, disaster/crime-prevention equipment and the like, the failure of which may directly or indirectly cause injury, death or property loss.

■ Anyone purchasing any products described or contained herein for an above-mentioned use shall:

- ① Accept full responsibility and indemnify and defend SANYO ELECTRIC CO., LTD., its affiliates, subsidiaries and distributors and all their officers and employees, jointly and severally, against any and all claims and litigation and all damages, cost and expenses associated with such use;
- ② Not impose any responsibility for any fault or negligence which may be cited in any such claim or litigation on SANYO ELECTRIC CO., LTD., its affiliates, subsidiaries and distributors or any of their officers and employees jointly or severally.

■ Information (including circuit diagrams and circuit parameters) herein is for example only; it is not guaranteed for volume production. SANYO believes information herein is accurate and reliable, but no guarantees are made or implied regarding its use or any infringements of intellectual property rights or other rights of third parties.

This catalog provides information as of January, 1997. Specifications and information herein are subject to change without notice.