

<b>SANYO</b>	No.3446A	<b>2SK1443</b>
		N-Channel Silicon MOSFET <b>Ultrahigh-Speed Switching Applications</b>

**Features**

- Low ON-state resistance.
- Ultrahigh-speed switching.
- Micaless package facilitating easy mounting.

**Absolute Maximum Ratings at Ta = 25°C**

			unit
Drain-to-Source Voltage	V <sub>DSS</sub>	450	V
Gate-to-Source Voltage	V <sub>GSS</sub>	±30	V
Drain Current(DC)	I <sub>D</sub>	1	A
Drain Current(Pulse)	I <sub>DP</sub>	PW ≤ 10μs, duty cycle ≤ 1%	4 A
Allowable Power Dissipation	P <sub>D</sub>	2.0	W
		Tc = 25°C	20 W
Channel Temperature	Tch	150	°C
Storage Temperature	Tstg	-55 to +150	°C

**Electrical Characteristics at Ta = 25°C**

			min	typ	max	unit
D-S Breakdown Voltage	V <sub>(BR)DSS</sub>	I <sub>D</sub> = 1mA, V <sub>GS</sub> = 0	450			V
Zero-Gate Voltage Drain Current	I <sub>DSS</sub>	V <sub>DS</sub> = 450V, V <sub>GS</sub> = 0			1.0	mA
Gate-to-Source Leakage Current	I <sub>GSS</sub>	V <sub>GS</sub> = ±30V, V <sub>DS</sub> = 0			±100	nA
Cutoff Voltage	V <sub>GS(off)</sub>	V <sub>DS</sub> = 10V, I <sub>D</sub> = 1mA	2.0		3.0	V
Forward Transfer Admittance	Y <sub>fs</sub>	V <sub>DS</sub> = 10V, I <sub>D</sub> = 0.5A	0.6	1.2		S
Static Drain-to-Source ON-State Resistance	R <sub>DS(on)</sub>	I <sub>D</sub> = 0.5A, V <sub>GS</sub> = 10V		3.5	4.5	Ω
Input Capacitance	C <sub>iss</sub>	V <sub>DS</sub> = 20V, f = 1MHz		250		pF
Output Capacitance	C <sub>oss</sub>	V <sub>DS</sub> = 20V, f = 1MHz		40		pF
Reverse Transfer Capacitance	C <sub>rss</sub>	V <sub>DS</sub> = 20V, f = 1MHz		8		pF
Turn-ON Delay Time	t <sub>d(on)</sub>	I <sub>D</sub> = 0.5A, V <sub>GS</sub> = 10V V <sub>DD</sub> = 200V, R <sub>GS</sub> = 50Ω		10		ns
Rise Time	t <sub>r</sub>		9		ns	
Turn-OFF Delay Time	t <sub>d(off)</sub>		45		ns	
Fall Time	t <sub>f</sub>		45		ns	
Diode Forward Voltage	V <sub>SD</sub>	I <sub>S</sub> = 1A, V <sub>GS</sub> = 0			1.8	V

(Note) Be careful in handling the 2SK1443 because it has no protection diode between gate and source.

**Switching Time Test Circuit**

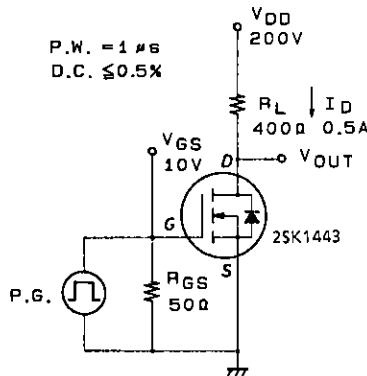

**Package Dimensions 2078B**

(unit : mm)

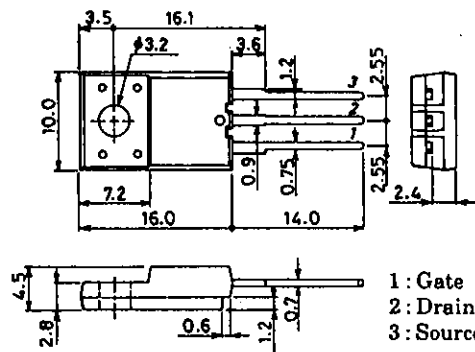

SANYO : TO-220FI(LS)

**SANYO Electric Co., Ltd. Semiconductor Business Headquarters**  
TOKYO OFFICE Tokyo Bldg., 1-10, 1 Chome, Ueno, Taito-ku, TOKYO, 110 JAPAN

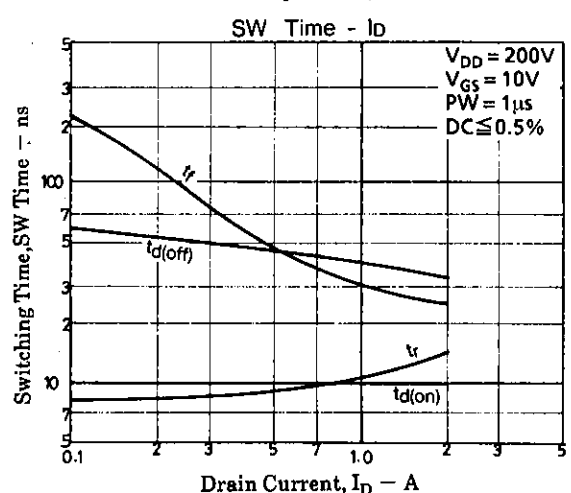
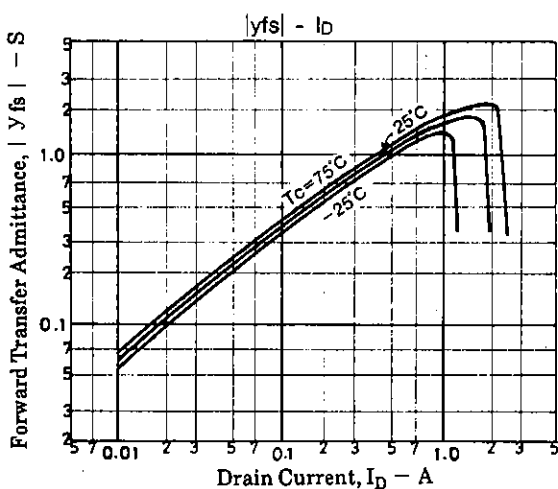
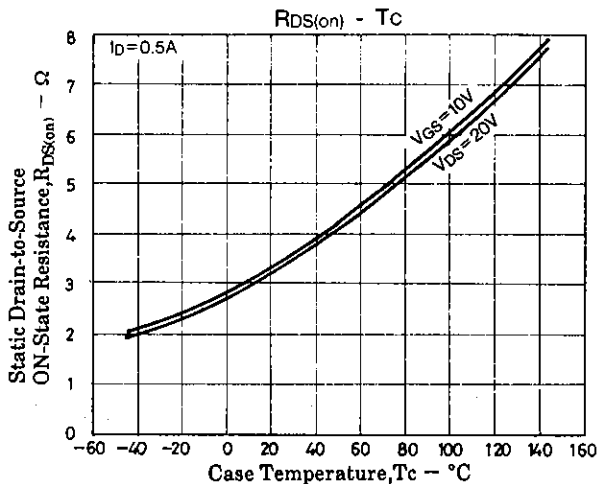
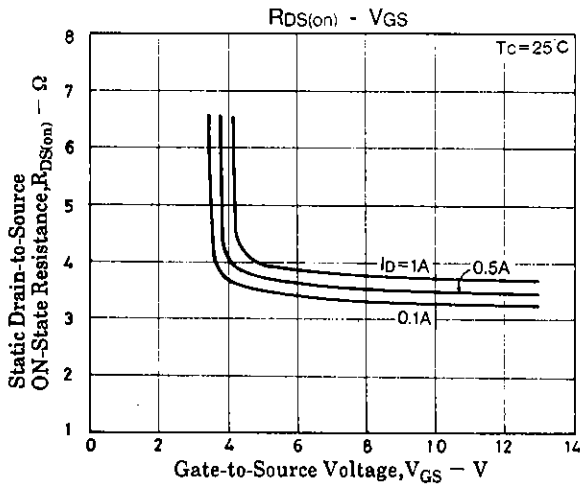
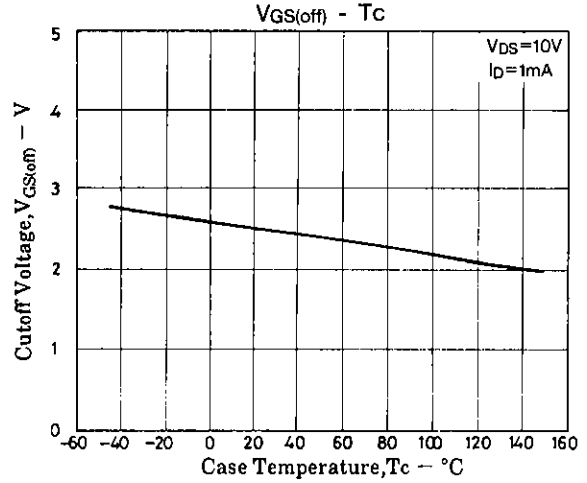
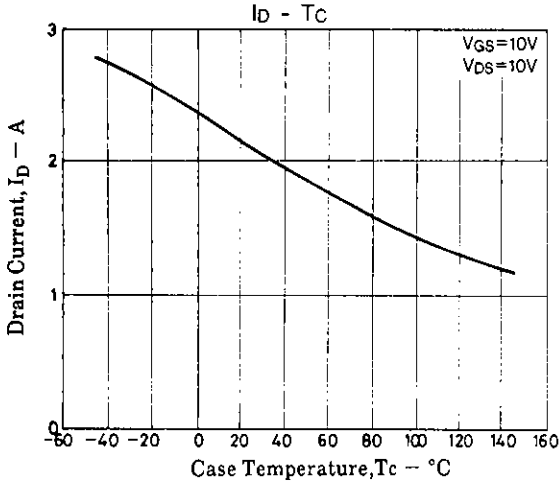
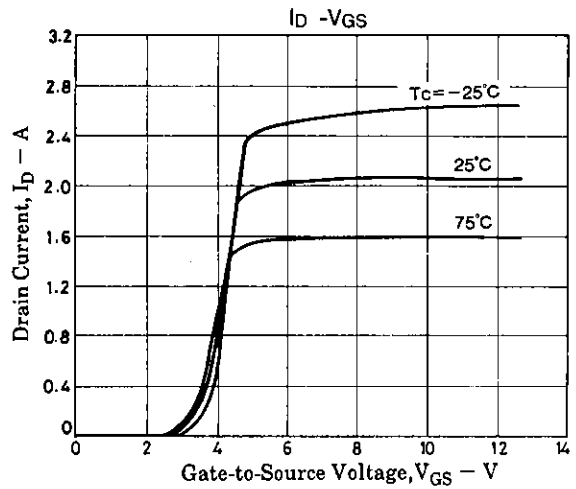
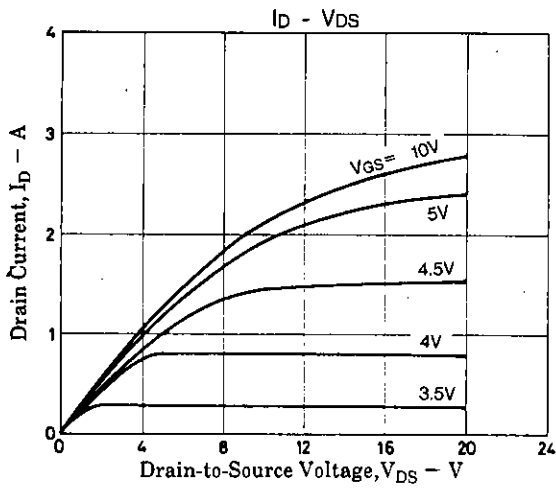

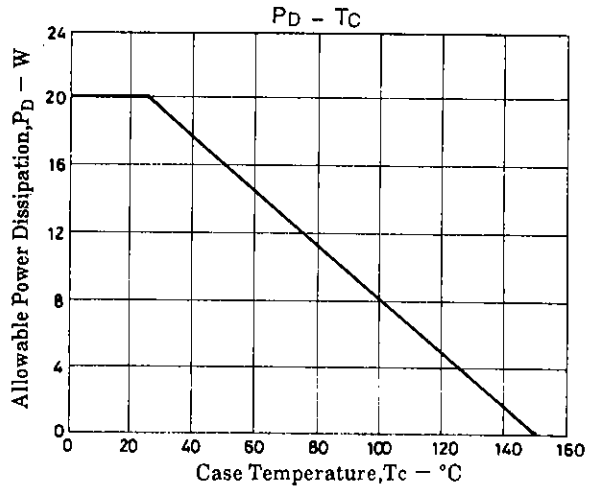
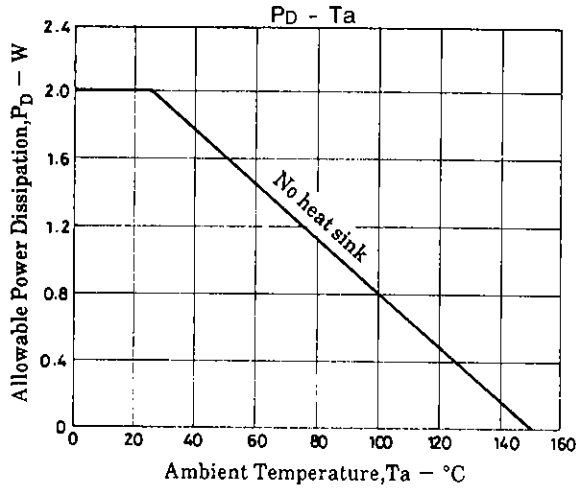
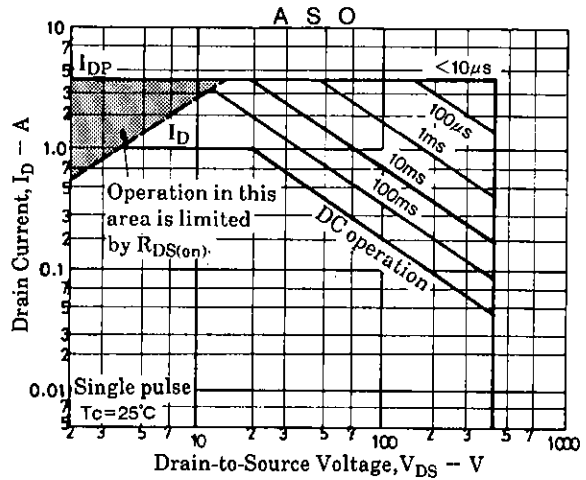
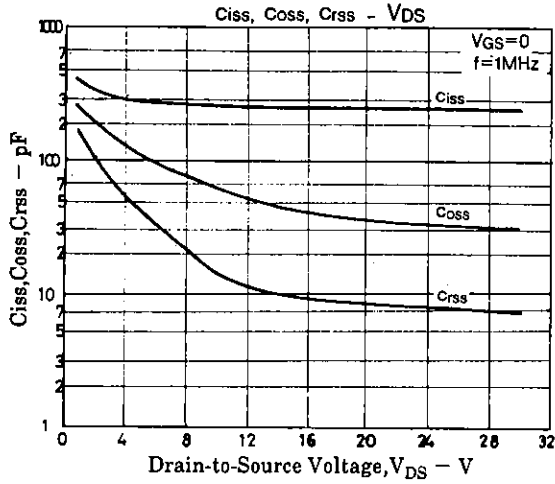

■ No products described or contained herein are intended for use in surgical implants, life-support systems, aerospace equipment, nuclear power control systems, vehicles, disaster/crime-prevention equipment and the like, the failure of which may directly or indirectly cause injury, death or property loss.

■ Anyone purchasing any products described or contained herein for an above-mentioned use shall:

- ① Accept full responsibility and indemnify and defend SANYO ELECTRIC CO., LTD., its affiliates, subsidiaries and distributors and all their officers and employees, jointly and severally, against any and all claims and litigation and all damages, cost and expenses associated with such use.
- ② Not impose any responsibility for any fault or negligence which may be cited in any such claim or litigation on SANYO ELECTRIC CO., LTD., its affiliates, subsidiaries and distributors or any of their officers and employees jointly or severally.

■ Information (including circuit diagrams and circuit parameters) herein is for example only; it is not guaranteed for volume production. SANYO believes information herein is accurate and reliable, but no guarantees are made or implied regarding its use or any infringements of intellectual property rights or other rights of third parties.

This catalog provides information as of July, 1997. Specifications and information herein are subject to change without notice.