

<b>SANYO</b>	No.4984A	<b>2SK2441</b>
		N-Channel Silicon MOSFET Ultrahigh-Speed Switching Applications

**Features**

- Low ON resistance.
- Ultrahigh-speed switching.
- 2.5V drive.

**Absolute Maximum Ratings at Ta = 25°C**

			unit
Drain-to-Source Voltage	V <sub>DSS</sub>	20	V
Gate-to-Source Voltage	V <sub>GSS</sub>	±12	V
Drain Current(DC)	I <sub>D</sub>	7	A
Drain Current(Pulse)	I <sub>DP</sub>	PW ≤ 10μs, duty cycle ≤ 1%	48 A
Allowable Power Dissipation	P <sub>D</sub>	Mounted on ceramic board (1000mm <sup>2</sup> × 0.8mm)	2.0 W
Channel Temperature	T <sub>ch</sub>	150	°C
Storage Temperature	T <sub>stg</sub>	-55 to +150	°C

**Electrical Characteristics at Ta = 25°C**

			min	typ	max	unit
D-S Breakdown Voltage	V <sub>(BR)DSS</sub>	I <sub>D</sub> = 1mA, V <sub>GS</sub> = 0	20			V
Zero-Gate Voltage Drain Current	I <sub>DSS</sub>	V <sub>DS</sub> = 16V, V <sub>GS</sub> = 0			100	μA
Gate-to-Source Leakage Current	I <sub>GSS</sub>	V <sub>GS</sub> = ±10V, V <sub>DS</sub> = 0			±10	μA
Cutoff Voltage	V <sub>GSS(off)</sub>	V <sub>DS</sub> = 10V, I <sub>D</sub> = 1mA	0.4		1.4	V
Forward Transfer Admittance	Y <sub>fs</sub>	V <sub>DS</sub> = 10V, I <sub>D</sub> = 7A	12	18		S
Static Drain-to-Source ON-State Resistance	R <sub>DS(on)1</sub>	I <sub>D</sub> = 7A, V <sub>GS</sub> = 4V		25	32	mΩ
	R <sub>DS(on)2</sub>	I <sub>D</sub> = 2A, V <sub>GS</sub> = 2.5V		37	48	mΩ
Input Capacitance	C <sub>iss</sub>	V <sub>DS</sub> = 10V, f = 1MHz		1300		pF
Output Capacitance	C <sub>oss</sub>	V <sub>DS</sub> = 10V, f = 1MHz		950		pF
Reverse Transfer Capacitance	C <sub>rss</sub>	V <sub>DS</sub> = 10V, f = 1MHz		400		pF
Turn-ON Delay Time	t <sub>d(on)</sub>	See specified Test Circuit.		30		ns
Rise Time	t <sub>r</sub>	"		190		ns
Turn-OFF Delay Time	t <sub>d(off)</sub>	"		190		ns
Fall Time	t <sub>f</sub>	"		180		ns
Diode Forward Voltage	V <sub>SD</sub>	I <sub>S</sub> = 7A, V <sub>GS</sub> = 0		1.0	1.2	V

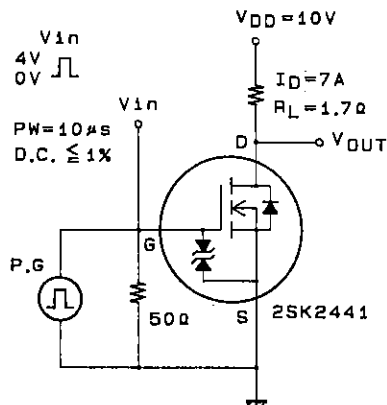
**Switching Time Test Circuit****Package Dimensions 2116**

(unit : mm)

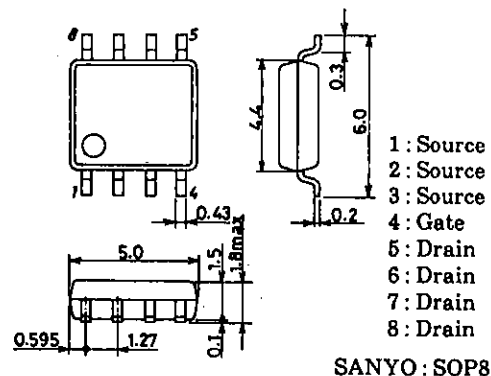

SANYO : SOP8

**SANYO Electric Co., Ltd. Semiconductor Business Headquarters**  
TOKYO OFFICE Tokyo Bldg., 1-10, 1 Chome, Ueno, Taito-ku, TOKYO, 110 JAPAN

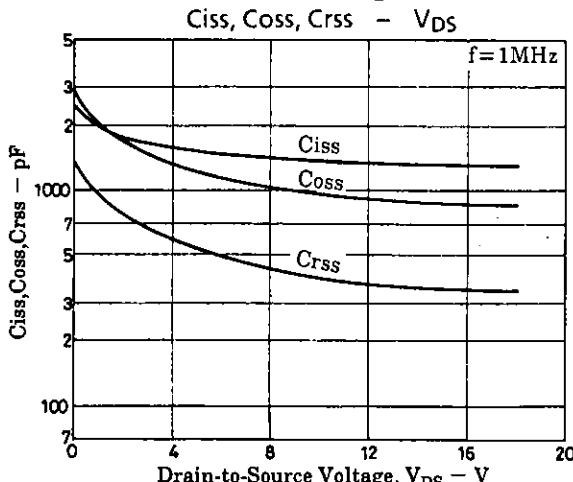
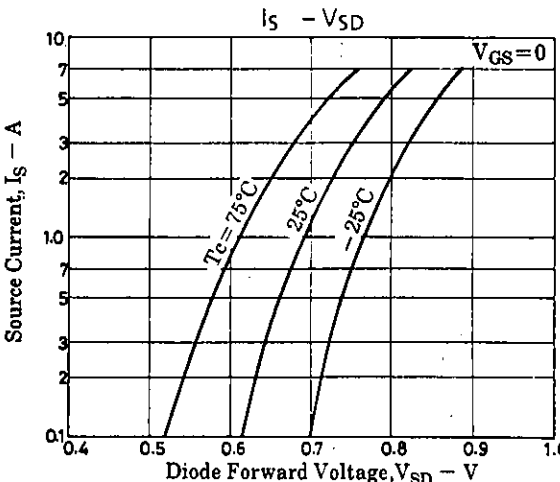
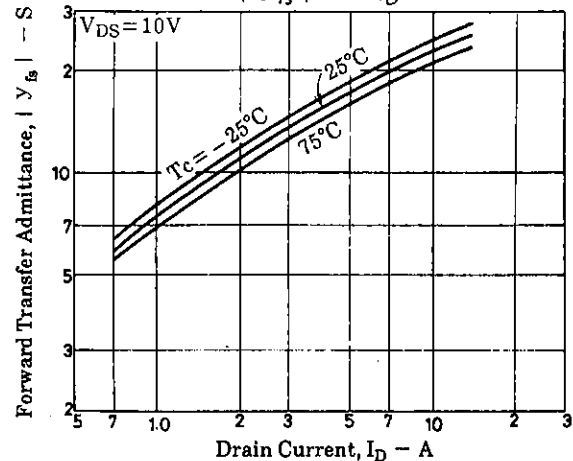
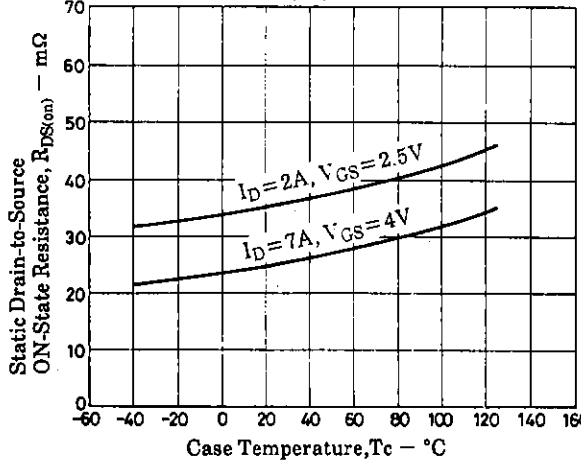
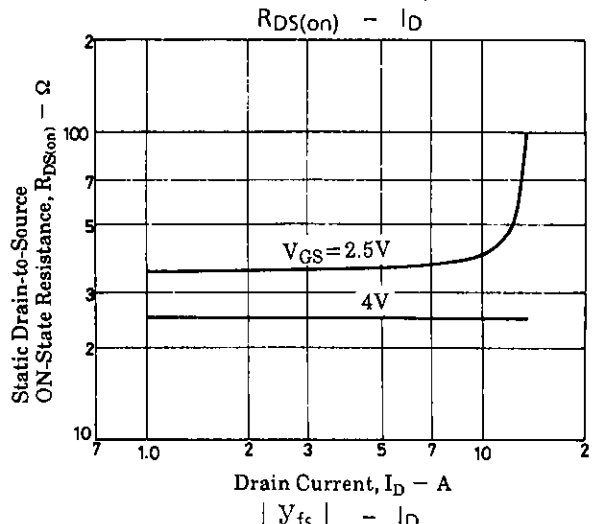
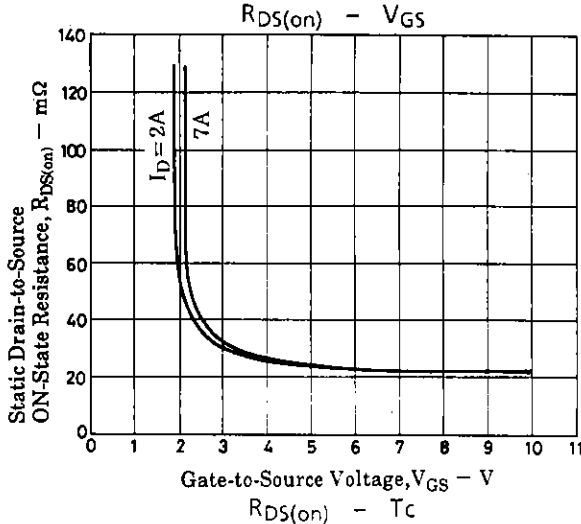
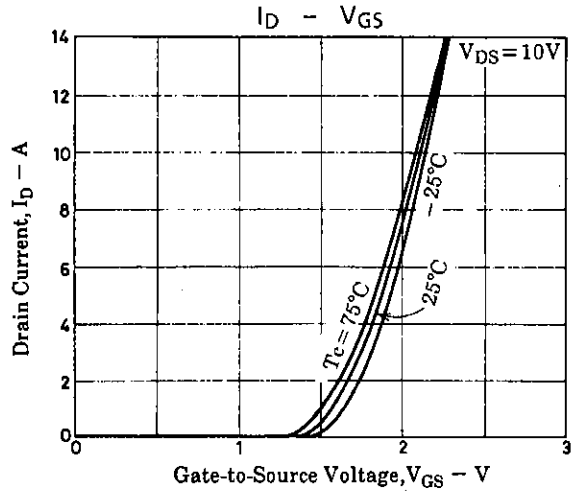
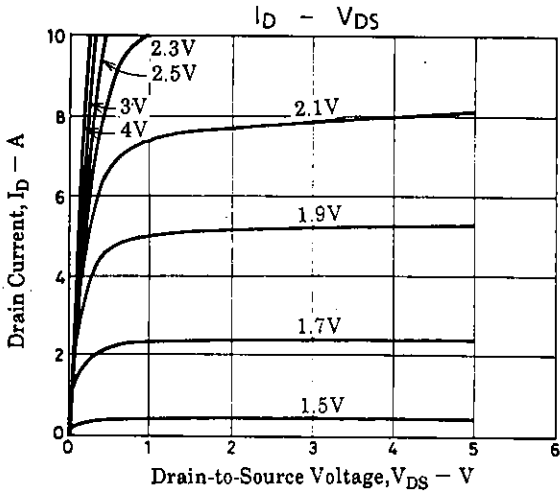

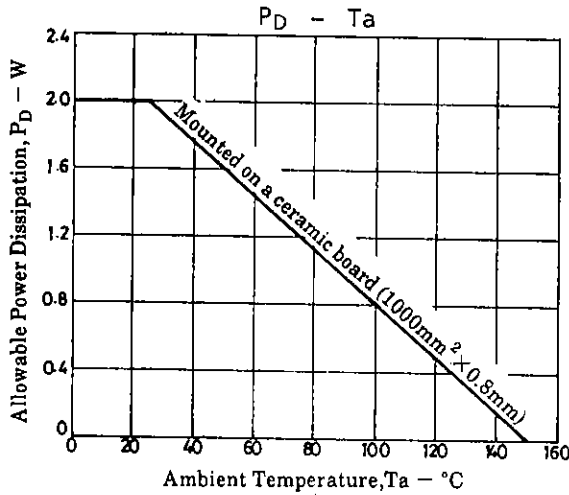
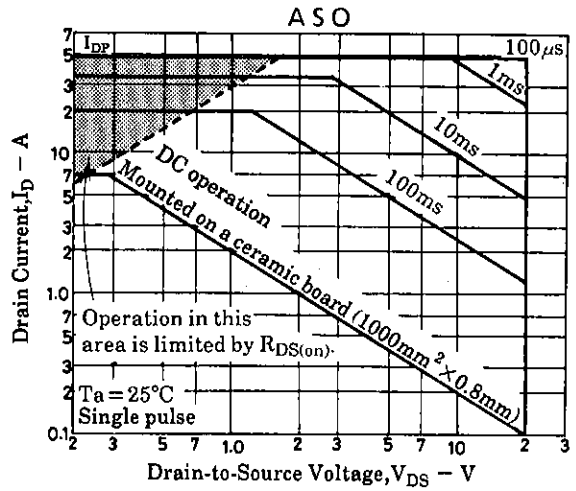
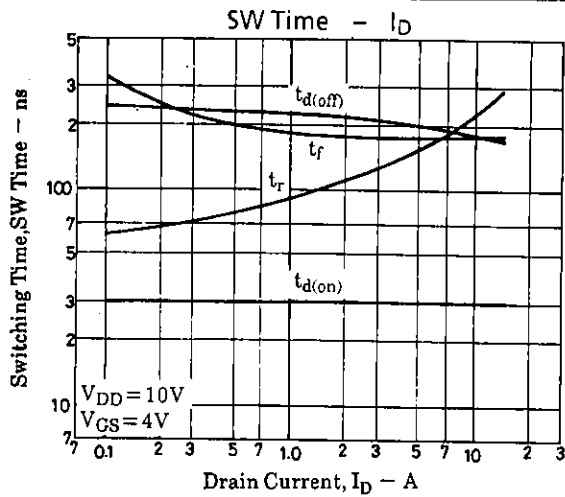

■ No products described or contained herein are intended for use in surgical implants, life-support systems, aerospace equipment, nuclear power control systems, vehicles, disaster/crime-prevention equipment and the like, the failure of which may directly or indirectly cause injury, death or property loss.

■ Anyone purchasing any products described or contained herein for an above-mentioned use shall:

- ① Accept full responsibility and indemnify and defend SANYO ELECTRIC CO., LTD., its affiliates, subsidiaries and distributors and all their officers and employees, jointly and severally, against any and all claims and litigation and all damages, cost and expenses associated with such use;
- ② Not impose any responsibility for any fault or negligence which may be cited in any such claim or litigation on SANYO ELECTRIC CO., LTD., its affiliates, subsidiaries and distributors or any of their officers and employees jointly or severally.

■ Information (including circuit diagrams and circuit parameters) herein is for example only; it is not guaranteed for volume production. SANYO believes information herein is accurate and reliable, but no guarantees are made or implied regarding its use or any infringements of intellectual property rights or other rights of third parties.

This catalog provides information as of July, 1997. Specifications and information herein are subject to change without notice.