

SANYO

No.726E

LA2211

ARI System-SK Type

As ICs for Autofahrer Rundfunk Information (ARI) system now prevalent in Europe, the LA2200, 2205, 2220 (traffic information broadcasting station identifying signal decoders/SK type) are already available. The LA2211 of this catalog is further equipped with all functions up to SDK system in conjunction with the LA2200, 2205, 2220. Each signal (tape, radio) is inputted into the LA2211 and each reception mode is simply changed-over by means of the control terminal with a priority circuit incorporated.

General Description of Functions

- 1) Change-over of each mode ("normal" : radio/tape, "ARI" : radio/tape)
 - . Each reception mode is set up by means of the control terminal.
- 2) Interruption
 - . Entering of DK signal (125Hz) being announcement indicating signal forces voice output of tape to be changed-over into voice output of FM reception.
- 3) Sound volume increase
 - . Entering of DK signal causes sound volume to increase to a certain level even with VR (volume control) turned down to a minimum.
- 4) Alarm
 - . If reception of ARI station being received becomes impossible owing to a problem such as distance, the alarm will notify you of necessity of reselecting the station.

Maximum Ratings at $T_a=25^\circ\text{C}$

				unit
Maximum Supply Voltage	V_{CCmax}	Pin 22 to 10, 13	15	V
"	"	Pin 2, 3, 4, 5 to 10, 13	5	V
"	"	Pin 6 to 10, 13	6	V
"	"	Pin 9 to 10, 13	5	V
"	"	Pin 11 to 10, 13	6	V
Input Current	I_{IN}	Pin 2, 3, 4, 5	1	mA
"	"	Pin 8	1	mA
"	"	Pin 12	2	mA
Output Current	I_{OUT}	Pin 14	1	mA
Allowable Power Dissipation	P_{dmax}		680	mW
Operating Temperature	T_{opr}		-20 to +60	$^\circ\text{C}$
Storage Temperature	T_{stg}		-40 to +125	$^\circ\text{C}$

Package Dimensions 3010A

(unit: mm)

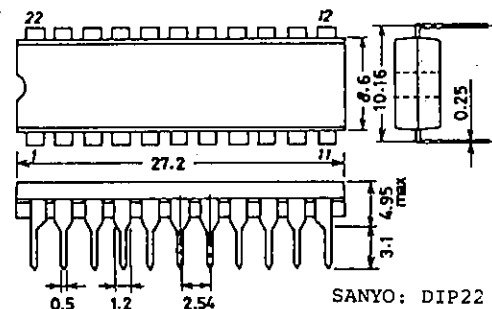

SANYO Electric Co., Ltd. Semiconductor Business Headquarters
 TOKYO OFFICE Tokyo Bldg., 1-10, 1 Chome, Ueno, Taito-ku, TOKYO, 110 JAPAN

LA2211

Recommended Operating Conditions at $T_a=25^\circ\text{C}$

				unit
Recommended Supply Voltage	V_{CC}	Pin 22 to 10, 13	8 to 14	V
Input Signal Voltage	V_{INDK}	Pin 21 to 10, 13	20 to 30	mV
Input Signal Voltage	V_{INAF}	Pin 17, 18, 19, 20, to 10, 13	200 to 300	mV

Operating Characteristics at $T_a=25^\circ\text{C}, V_{CC}=12\text{V}, V_{INDK}=25\text{mV}, V_{INAF}=300\text{mV}$

			min	typ	max	unit
Quiescent Current	I_{CCO}	Radio mode	22	31	44	mA
Input Resistance	r_i	Pin 17, 18, 21	7	10		kohm
		Pin 19, 20	14	20		kohm
ARI Change-over Level	V_{INDKCH}	ARI mode, V_{INDK}	7		15	mV
Hysteresis	hy	"			6	dB
Capture Range	CR	"		16		Hz
Total Harmonic Distortion	THD R	$V_{INAF}=300\text{mV}$		0.2	1.0	%
"	THD T	"		0.2	1.0	%
"	THD I	"		0.3	1.5	%
Output Level	V_{OR}	"	180	270	360	mV
"	V_{OT}	"	180	270	360	mV
"	V_{OI}	"	99	140	198	mV
Channel Separation		Pin 15 to 16	40	60		dB
Mode Change-over Voltage*	$V_{CIR \rightarrow T}$	Pin 6		0.6	0.8	V
"	$V_{CIT \rightarrow A}$	Pin 6	1.7	2.4	3.0	V
"	$V_{C2TA \rightarrow RA}$	Pin 12		0.7	0.9	V
"	V_{ALARM}	Pin 8	1.4	1.9	2.4	V
500Hz Leakage Level	V_{500}	Pins 14, 15, 16 ARI mode	-110			dBV

(Note) . Explanation of symbol

R : Radio mode T : Tape mode I : Sound volume increase

A : ARI mode

. Sign *

Threshold of voltage to be changed-over. For the actual setting, refer to Table of Operation Mode.

. 0V, 1.2V, 3.5V are required for setting of radio, tape, ARI mode respectively.

. 3.5V is required for V_{ALARM} .

Fig. 1 Test Circuit

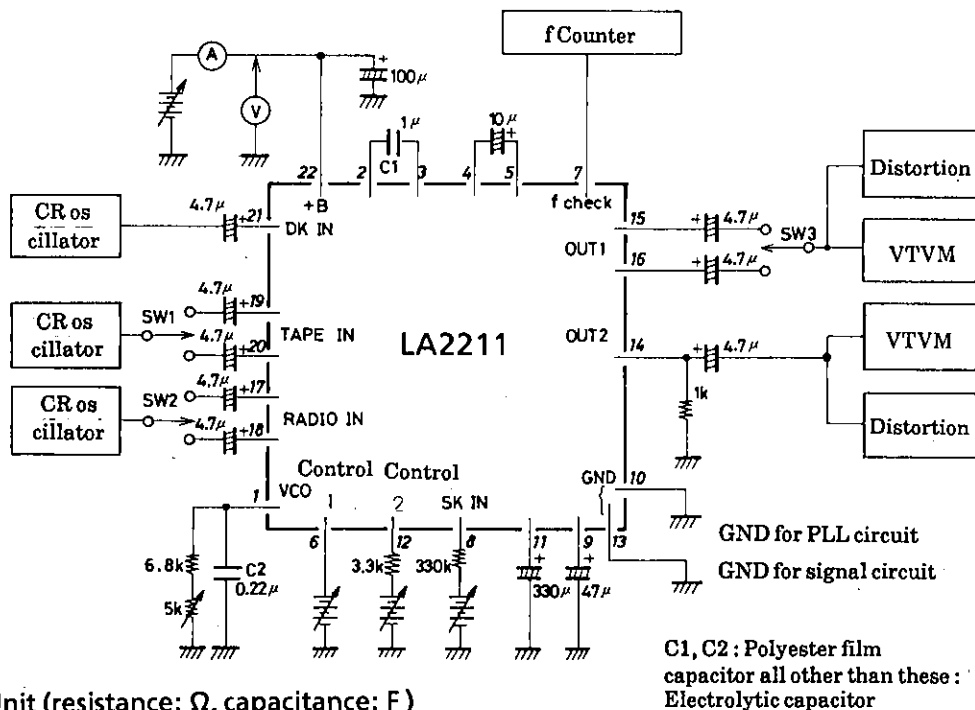
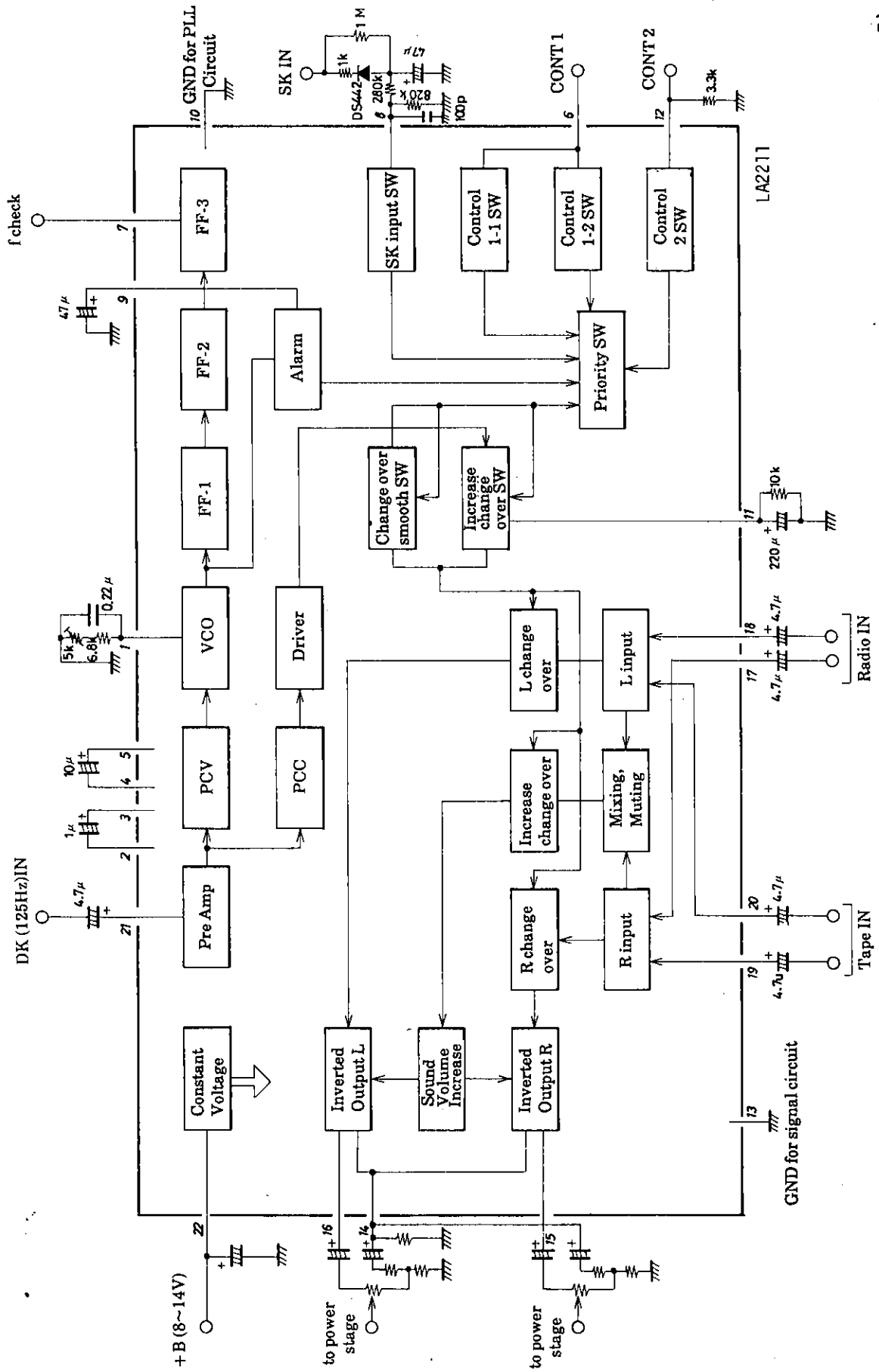

Fig. 2 Equivalent Circuit Block Diagram



Unit (resistance: Ω, capacitance: F)

1. Explanation of operation by LA2211 block

The fundamental functions of DK signal processing block are divided into the following 2 categories.

- 1) Output signal will result as follows by means of input of DK signal (125kHz).
 - a) FM₁ is transferred to FM₂ (sound volume increase).
 - b) Tape is transferred to FM₂ (interruption, sound volume increase).
- 2) With SK reception indicating lamp OFF (LA2200,2205,2220)(impossible to receive SK station), output signal will become as follows.
 - a) Tape, FM₁, FM₂ are changed to alarm activated mode.

The LA2211 is equipped with the following a) to c) functions in addition to these 2 functions.

- a) On account of interruption function, radio and tape signals are concentrated in DK signal processing block.
 - b) Because of a) above, change-over of tape and radio in the normal mode is carried out in this block.
 - c) Therefore, the control terminal and priority circuit are equipped for changing-over each mode of "normal" (radio, tape) and "ARI" (radio, tape). This circuit makes the external switch circuit for mode change-over very simple.
- a) to c) are summarized as follows.
- 3) The control terminal and priority circuit are equipped for changing-over each mode of "normal" and "ARI".

The LA2211 is equipped with these 3 functions, and the circuit block to realize these functions are roughly divided into 6 blocks.

Block 1: PLL circuit for DK signal (125Hz) check

When DK signal is inputted from pin 21, internal PLL checks 125Hz, driving the voice signal change-over switch.

- Pin 1 : 500Hz oscillation terminal
- Pins 2,3: PLL capture range fixing terminal (Phase comparator)
- Pins 4,5: Smoothing capacitor terminal for 125Hz in-phase detection
- Pin 7 : 125Hz check terminal

Block 2: Voice signal change-over smoothing circuit

Voice signal can be changed-over (interruption, increase) by means of DK signal input. Consideration is given so that this change-over occurs smoothly, not suddenly. The external capacitor of pin 11 is used for this purpose.

Block 3: Voice signal processing change-over switch circuit

- Pins 17,18: Radio signal input terminal
- Pins 19,20: Tape signal input terminal
- Pins 15,16: Signal output terminal
- Pin 14 : Output terminal for sound volume increase

Combination of L, R channels is as follows.

Output of pins 17, 19 is outputted at pin 15, and output of pins 18, 20 is outputted at pin 16. Pin 14 is for monaural output.

Block 4: Alarm activate circuit

With SK reception indicating lamp OFF (LA2200,2205,2220), SK IN terminal of pin 8 rises to more than 2.1V in voltage and alarm is activated. The period of time from lamp off to alarm activation is fixed by the time constant of C, R externally attached to pin 8. Alarm is 500Hz in frequency and the repeated frequency is fixed by the value of C externally attached to pin 9.

Block 5: Control switch of each mode and priority circuit

For operation of control 1 (pin 6), control 2 (pin 12), refer to Table 1.

Block 6: Other (constant voltage bias) circuit

2. Explanation of operation mode of LA2211

The operation mode of the LA2211 is roughly divided into 2 modes of "normal" and "ARI". These depend on control voltage to each control terminal. Table 1 shows the summary.

Table 1 Operation mode of LA2211

Control Signal	Mode		A R I						
	Normal		A R I - 1				A R I - 2		
	Radio (AM/FM)	Tape	(FM ₁ → FM ₂ → Alarm)				(Tape → FM ₂ → Alarm)		
Control 1	11 0	21 ½	31 1	41 1	51 1	61 1	71 1	81 1	
Control 2	12 —	22 —	32 1	42 1	52 1	62 0	72 0	82 0	
DK signal	13 —	23 —	33 0	43 1	53 —	63 0	73 1	83 —	
SK IN	14 —	24 —	34 0	44 0	54 1	64 0	74 0	84 1	
Output signal 1	15 Radio	25 Tape	35 FM ₁	45 FM ₂	55 Alarm	65 Tape	75 FM ₂	85 Alarm	
Output signal 2	16 None	26 None	36 None	46 FM ₂	56 Alarm	66 None	76 FM ₂	86 Alarm	

Explanation of symbol

Control signal	Pin No.	0	½	1	Remarks
Control 1	6	0 V	1.2 V	3.5 V	All typ. value
Control 2	12	0 V	—	0.8V (500 μA)	"
DK signal	21			10.5 mV	"
SK IN	8	0 V		2.1 V	"

- FM1 : FM signal output in a state with no DK signal
 FM2 : FM signal output in a state with DK signal (traffic information)
 — : Not related.
 32 : Figure of top left shows address of box.
 Output signal 1 : Output signal from terminals 15, 16
 Output signal 2 : Output signal from terminal 14 (output for sound volume increase)

For example, if control 1 is at (1/2), output signal will be at addresses 25, 26 irrespective of the presence or absence of other control signals (control 2, DK signal, and SK IN). Next, the mode where control 1, control 2, DK signal, and SK IN are at (1), (0), (0), and (0) respectively shows addresses 65 to 66, and if DK signal is transferred from (0) to (1), addresses 75 to 76 will result. Further, if SK IN is transferred from (0) to (1), addresses 85 to 86 will result.

3. Explanation of each characteristic and proper cares in using IC

- Supply voltage and ripple rejection characteristics
 Current dissipation characteristic, power dissipation characteristic, and ripple rejection characteristic are shown in Fig. 4, Fig. 5, and Figs. 6 and 7 respectively. Voice signal change-over circuit characteristic, free run frequency characteristic of 125Hz check PLL, change-over level characteristic are shown in Fig. 8, Fig. 9 and Fig. 10 respectively. As seen from these characteristics charts, the operating voltage should be in the range of 8V to 14V.
- Each control voltage setting
 As mentioned above, each terminal voltage of control 1, control 2, SK IN causes transfer to each mode. Figs. 11 to 14 show these transfers. As a result, voltage setting of each mode is as shown in Table 1 above.

Output of pins 15, 16 (tape signal) and output (alarm) of pins 13, 14 overlap in the range of 1.7V to 1.9V of SK IN terminal voltage (pin 8) in Fig. 14, that is, 2 kinds of signals are to be heard simultaneously, but this can be prevented practically in the following way.
 The rising time of pin 9 is made longer than the time when SK IN terminal voltage (pin 8) passes through 1.7V to 1.9V.

- . Input level setting
 Input level (pins 17, 18, 19, 20) vs. distortion factor characteristic is shown in Fig. 15. From this characteristic chart, it is seen that input level should be suppressed to 400mV or less.
- . Capture range and lock range
 These characteristics charts are shown in Fig. 16.
- . Temperature characteristic of free run frequency
 The characteristic chart is shown in Fig. 17.

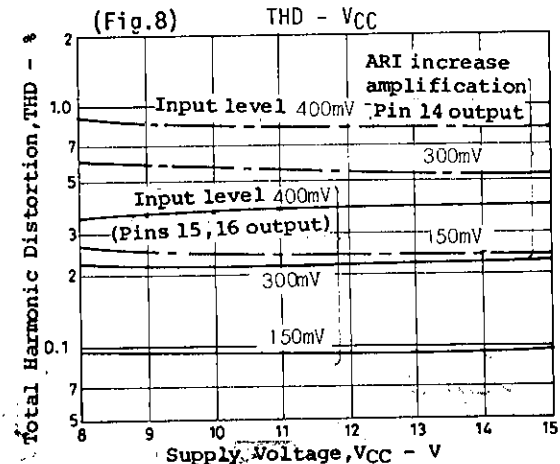
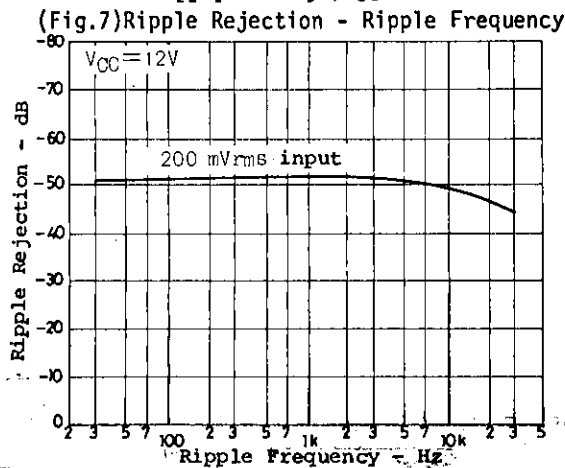
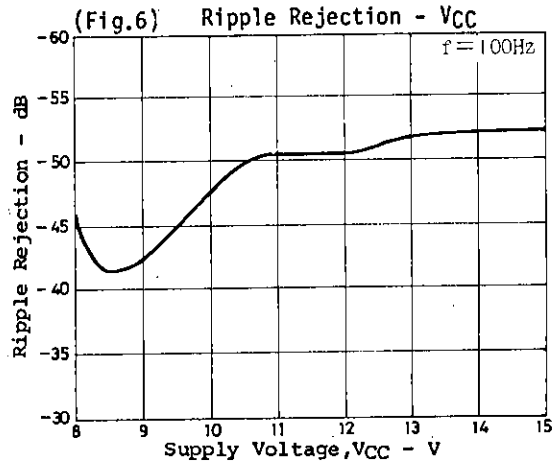
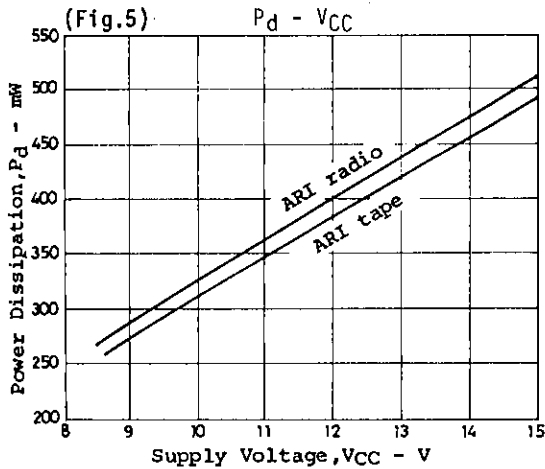
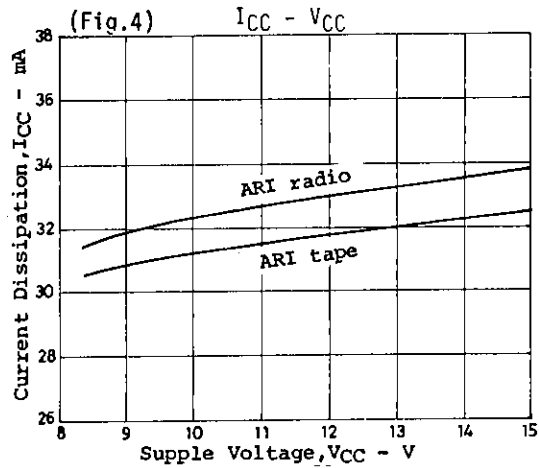
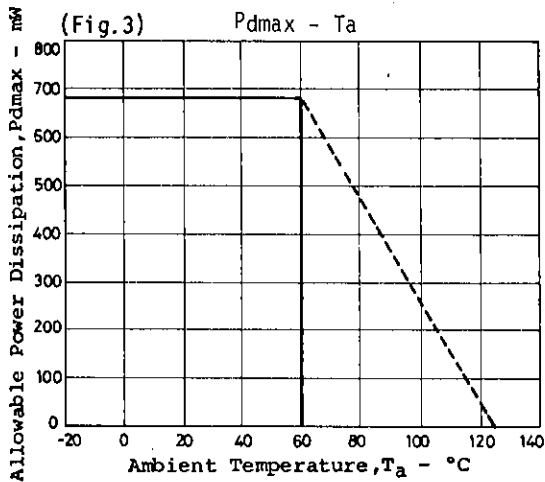

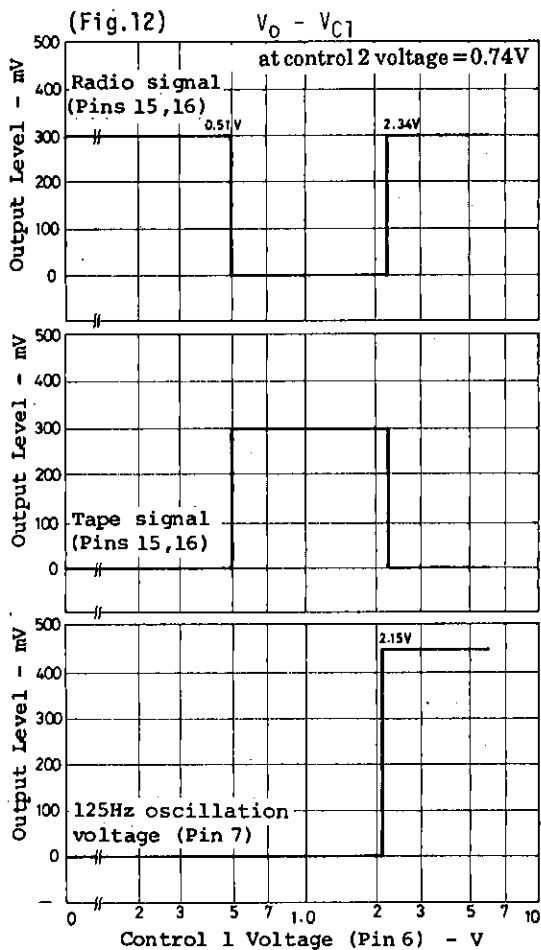
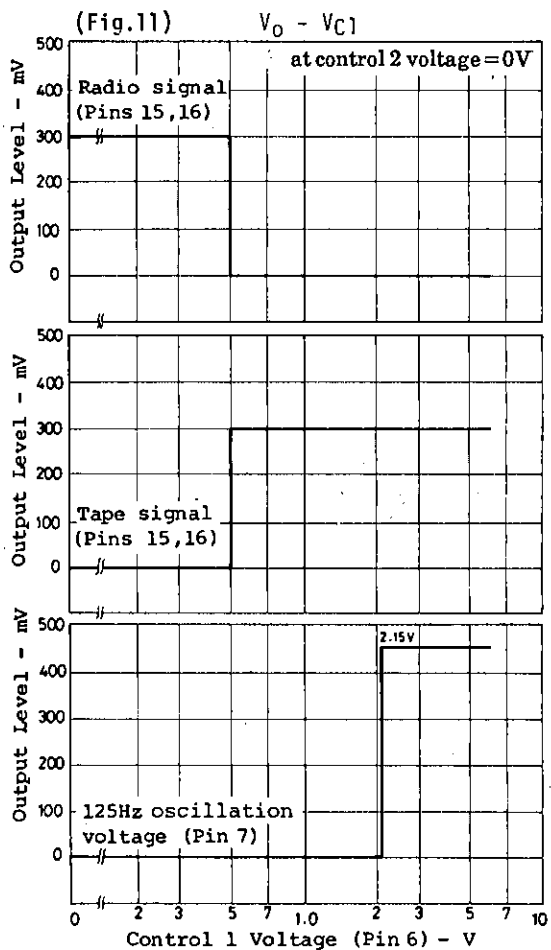
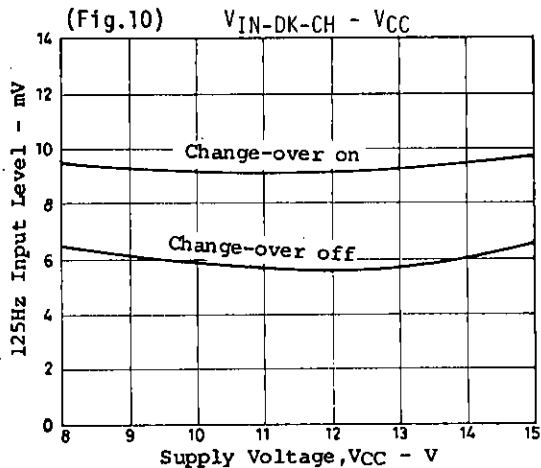
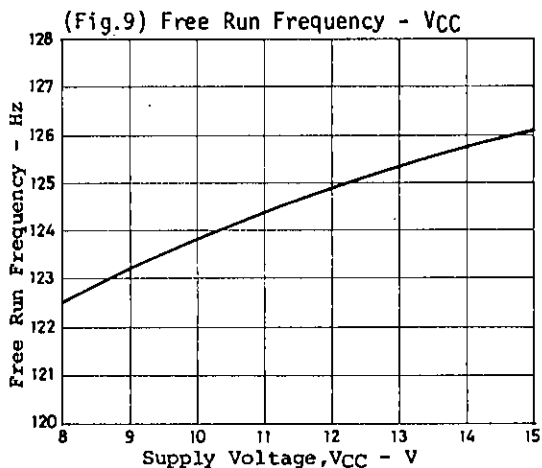

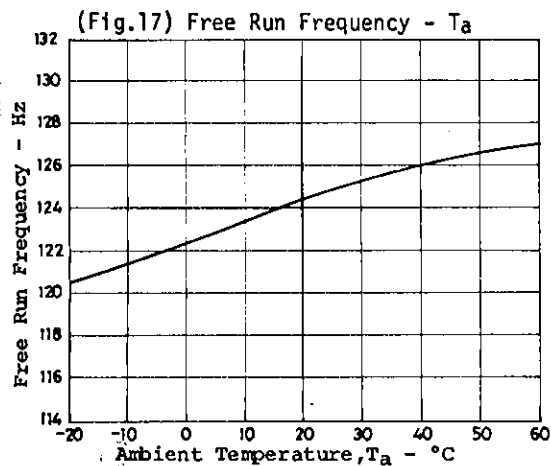
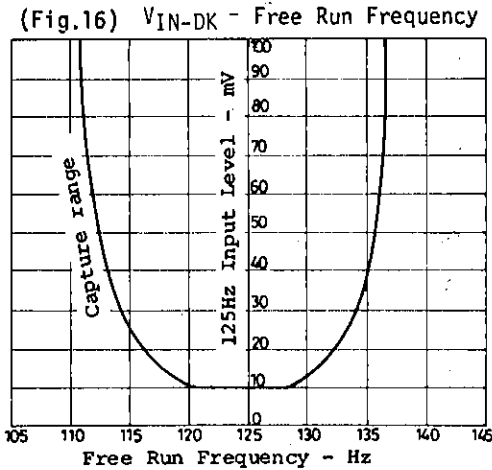
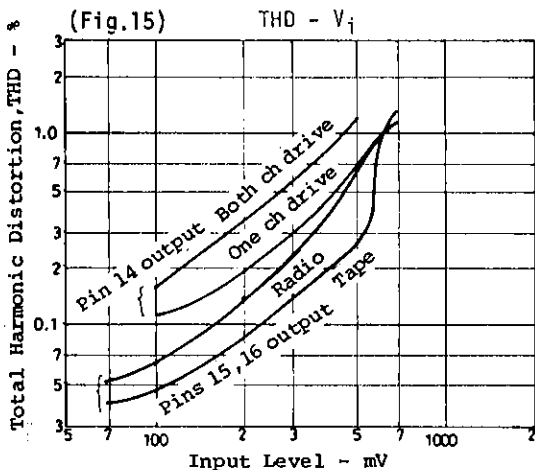
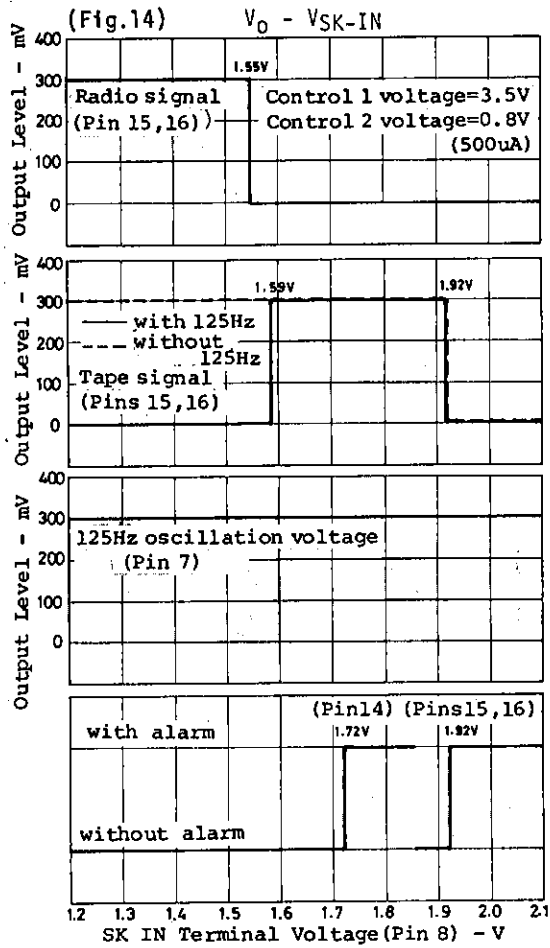
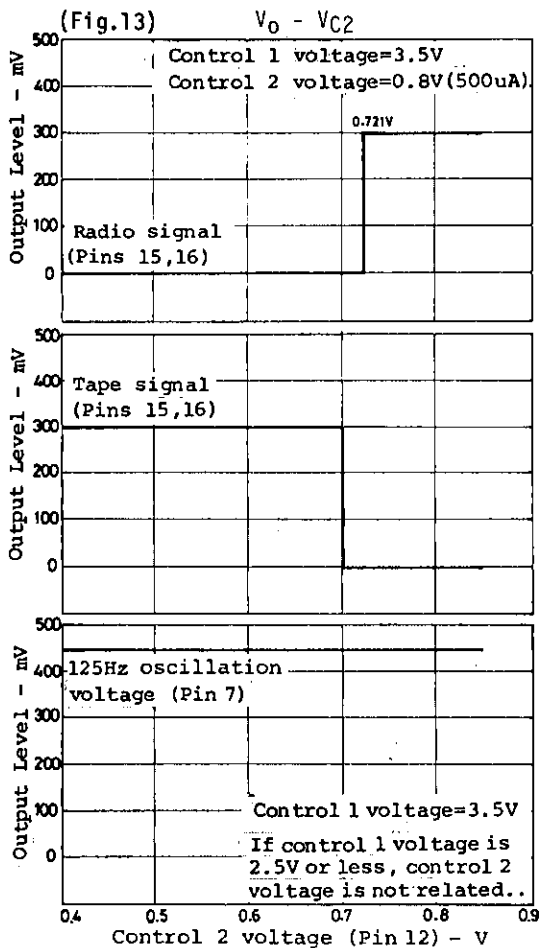

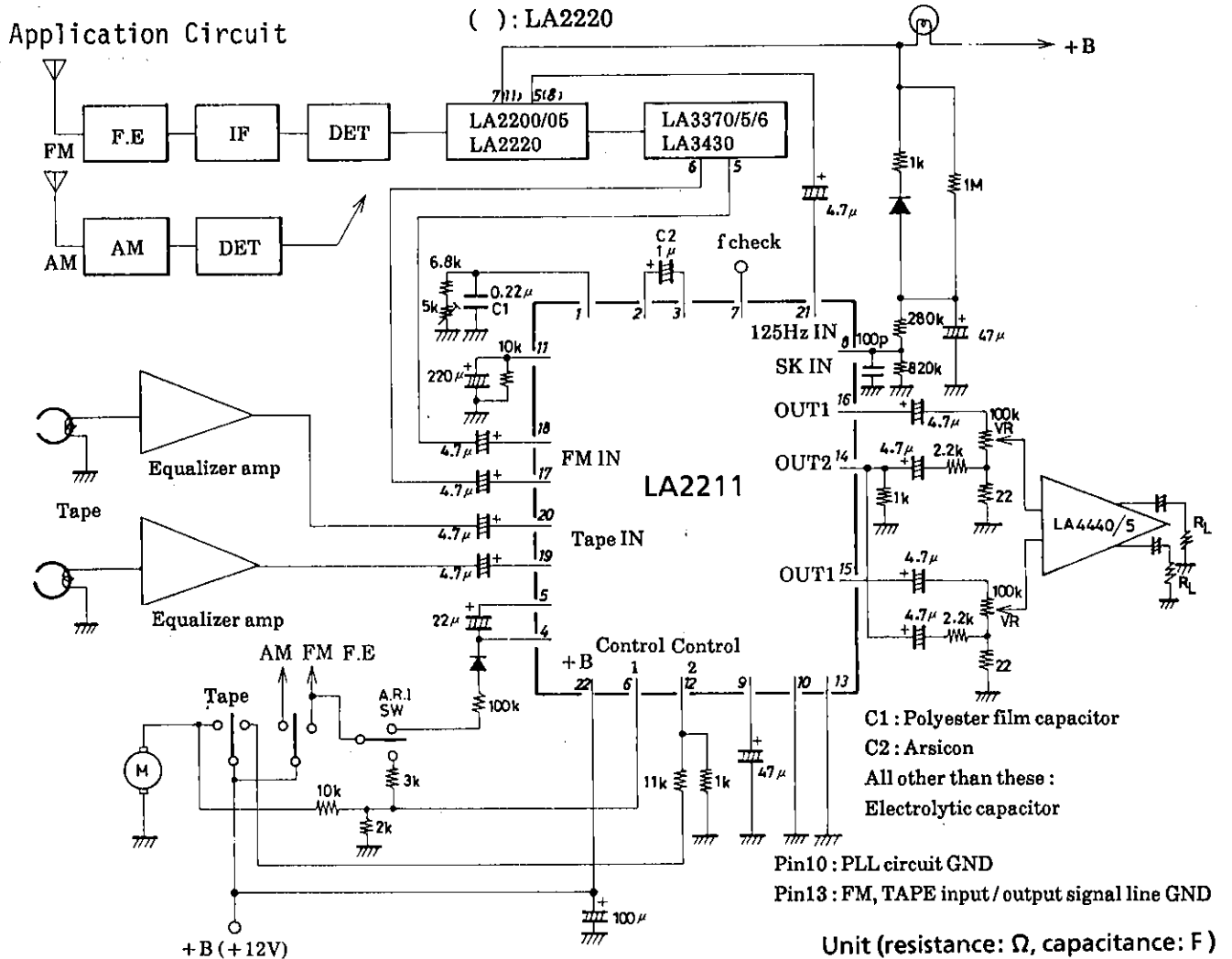

Proper cares in designing

- GND pattern of pins 10, 13 (500Hz leakage prevention)
- PLL circuit GND of pin 10 and FM, TAPE input signal, OUT1, OUT2 output signal line GND of pin 13.
- GND is divided into 2 lines of pins 10, 13, which are connected on the pattern. In this case, the GND pattern between pin 10 and oscillation time constant C, R (C,R at pin 1 of LA2211), decoupling capacitor should be made as heavy and short as possible and the GND pattern between pin 13 and FM, TAPE, OUT1, OUT2 input/output signal lines should be also made as heavy and short as possible in order to minimize 500Hz leakage to the output. See below.

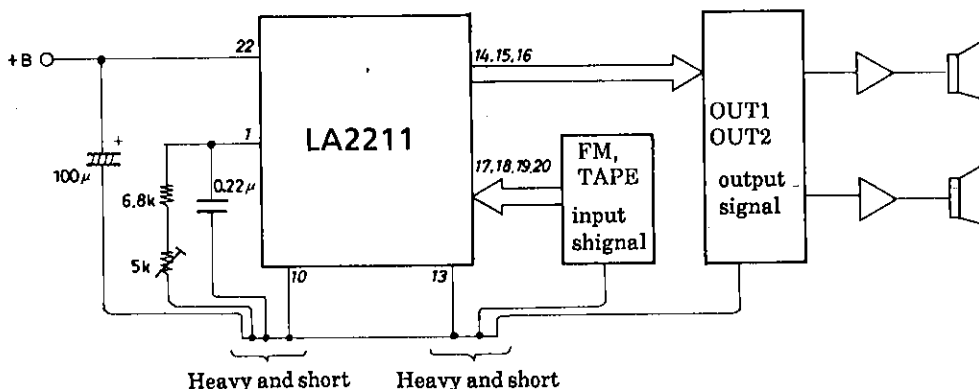

- Measures against noise immediately before generation of alarm sound
When SK signal in the composite signal disappears and SK lamp goes OFF, the time constant of external C, R causes pin 8 voltage to rise gradually. When 1.8 to 2.1V or more is reached, alarm is generated and the output signal is changed from FM or TAPE signal to alarm sound. At this moment, noise may be delivered momentarily from the output. In this case, connect a ceramic capacitor of approximately 100pF across pin 8 and GND to reject noise.
- It is recommended to use as large a resistance value as possible (100kohms) of the volume control.
A small resistance value of the volume control (30kohms or less) makes D range of OUT2 output (pin 14) narrow, which may cause the output waveform to be clipped at the time of turning up the volume.
For $R_3=10\text{kohms}$, $R_4=2.2\text{kohms}$ is required for causing no leakage of sound at "0" level of the volume control ($R_3 \gg R_4$). Since pin 14 output signal is attenuated (app. 40dB) by $R_4/(R_2+R_4)$, $R_2=220\text{kohms}$ is obtained for $R_4=2.2\text{kohms}$. Then, the AC load viewed from pin 14 becomes too small (182ohms) and D range of pin 14 output narrows.

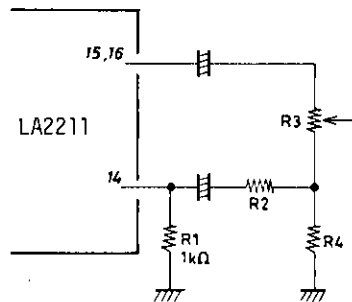

- No products described or contained herein are intended for use in surgical implants, life-support systems, aerospace equipment, nuclear power control systems, vehicles, disaster/crime-prevention equipment and the like, the failure of which may directly or indirectly cause injury, death or property loss.
- Anyone purchasing any products described or contained herein for an above-mentioned use shall:
 - ① Accept full responsibility and indemnify and defend SANYO ELECTRIC CO., LTD., its affiliates, subsidiaries and distributors and all their officers and employees, jointly and severally, against any and all claims and litigation and all damages, cost and expenses associated with such use:
 - ② Not impose any responsibility for any fault or negligence which may be cited in any such claim or litigation on SANYO ELECTRIC CO., LTD., its affiliates, subsidiaries and distributors or any of their officers and employees jointly or severally.
- Information (including circuit diagrams and circuit parameters) herein is for example only; it is not guaranteed for volume production. SANYO believes information herein is accurate and reliable, but no guarantees are made or implied regarding its use or any infringements of intellectual property rights or other rights of third parties.