



## STK4151V

### AF Power Amplifier (Split Power Supply) (30W + 30W min, THD = 0.08%)

#### Features

- Built-in muting circuit to cut off various kinds of pop noise.
- Greatly reduced heat sink due to substrate temperature 125°C guaranteed.
- Distortion 0.08% due to current mirror circuit.
- Pin-compatible with the STK4101II series. The STK4101V series use the same package and are available for output 6W to 50W.
- Excellent cost performance.

#### Package Dimensions

unit: mm

4040

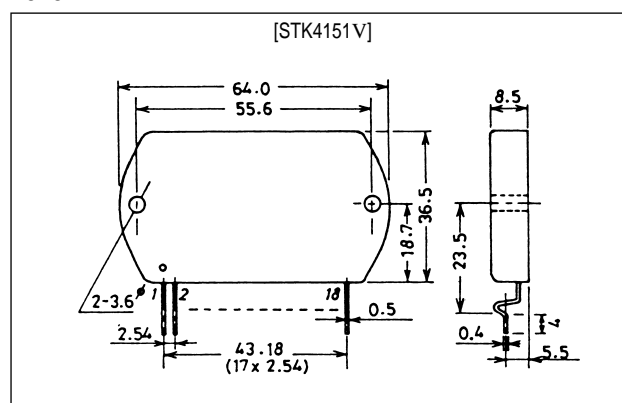

#### Specifications

Maximum Ratings at  $T_a = 25^\circ\text{C}$

Parameter	Symbol	Conditions	Ratings	Unit
Maximum supply voltage	$V_{CC}$ max		$\pm 42.0$	V
Thermal resistance	$\theta_{j-c}$		2.1	$^\circ\text{C}/\text{W}$
Junction temperature	$T_{jmax}$		150	$^\circ\text{C}$
Operating substrate temperature	$T_c$		125	$^\circ\text{C}$
Storage temperature	$T_{stg}$		-30 to +125	$^\circ\text{C}$
Available time for load short-circuit	$t_s$	$V_{CC} = \pm 28\text{V}$ , $R_L = 8\Omega$ , $f = 50\text{Hz}$ , $P_o = 30\text{W}$	2	s

Recommended Operating Conditions at  $T_a = 25^\circ\text{C}$

Parameter	Symbol	Conditions	Ratings	Unit
Recommended supply voltage	$V_{CC}$		$\pm 28.0$	V
Load resistance	$R_L$		8	$\Omega$

**Operating Characteristics** at  $T_a = 25^\circ\text{C}$ ,  $V_{CC} = \pm 28.0\text{V}$ ,  $R_L = 8\Omega$  (non-inductive),  $R_g = 600\Omega$ ,  $V_G = 40\text{dB}$  unless otherwise specified, at specified test circuit (based on sample application circuit)

Parameter	Symbol	Conditions	min	typ	max	Unit
Quiescent current	$I_{CCO}$	$V_{CC} = \pm 33.5\text{V}$	20	40	100	mA
Output power	$P_O(1)$	$f = 20\text{Hz to } 20\text{kHz}$ , THD = 0.08%	30			W
	$P_O(2)$	$V_{CC} = \pm 25\text{V}$ , $f = 1\text{kHz}$ , THD = 0.2%, $R_L = 4\Omega$	35			W
Total harmonic distortion	THD	$f = 1\text{kHz}$ , $P_o = 1\text{W}$			0.08	%
Frequency response	$f_L, f_H$	$P_o = 1\text{W}$ , $+0$ $-3$ dB		20 to 50k		Hz
Input impedance	$r_i$	$f = 1\text{kHz}$ , $P_o = 1\text{W}$		55		$k\Omega$
Output noise voltage	$V_{NO}$	$V_{CC} = \pm 33.5\text{V}$ , $R_g = 10k\Omega$			1.2	mVrms
Neutral voltage	$V_N$	$V_{CC} = \pm 33.5\text{V}$	-70	0	+70	mV
Muting voltage	$V_M$		-2	-5	-10	V

Note : For power supply at the time of test, use a constant-voltage power supply unless otherwise specified.

\* For measurement of the available time for load short-circuit and output noise voltage, use the specified transformer power supply shown right.

\*\* The output noise voltage is represented by the peak value on rms scale (VTVM) of average value indicating type. For AC power supply, use an AC stabilized power supply (50Hz) to eliminate the effect of flicker noise in AC primary line.

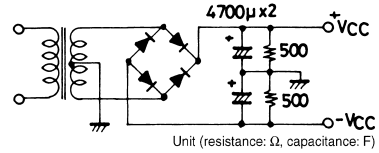

Specified transformer power supply  
(Equivalent to RP-25)

### Equivalent Circuit

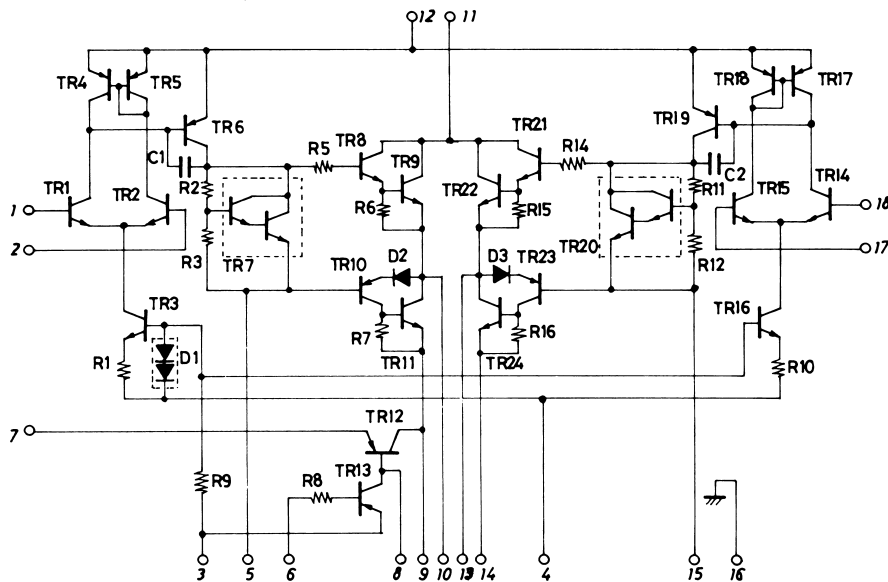

Sample Application Circuit: 30W min AF Power Amplifier (2 channels)

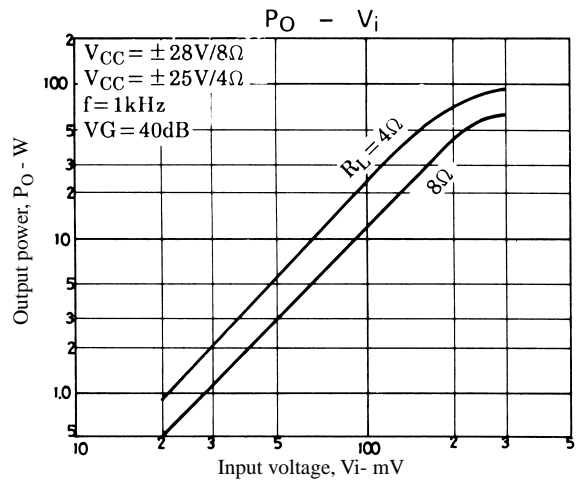
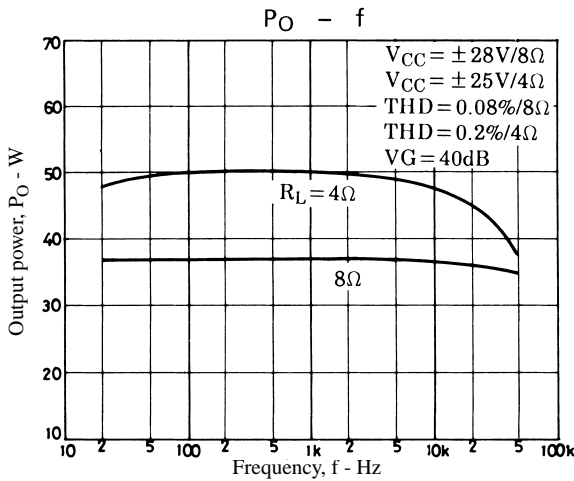
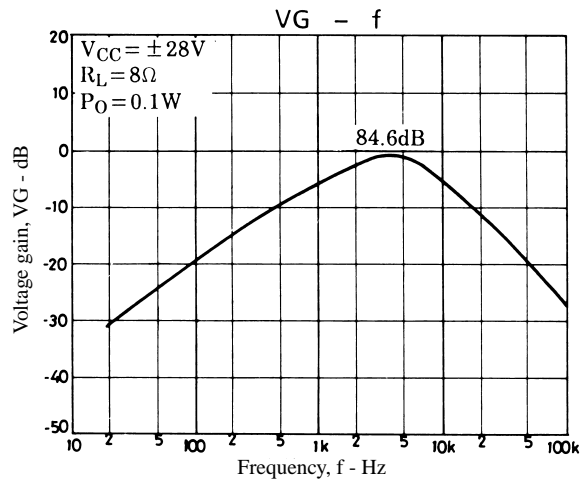
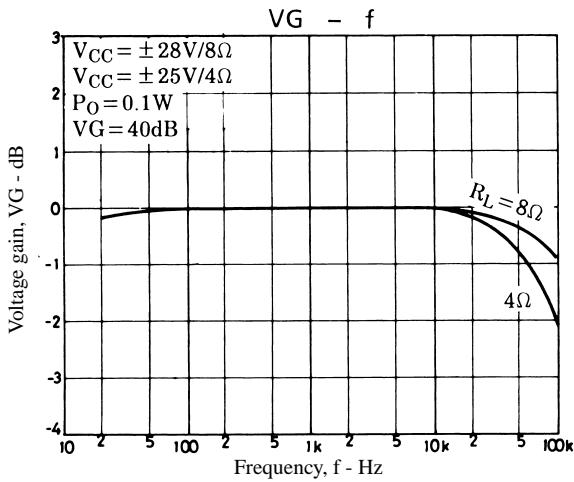
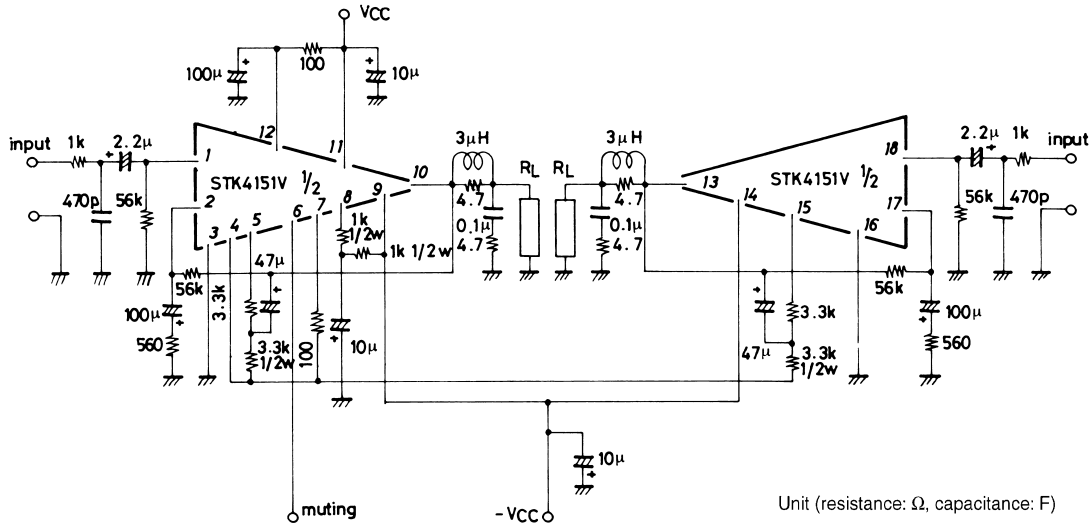

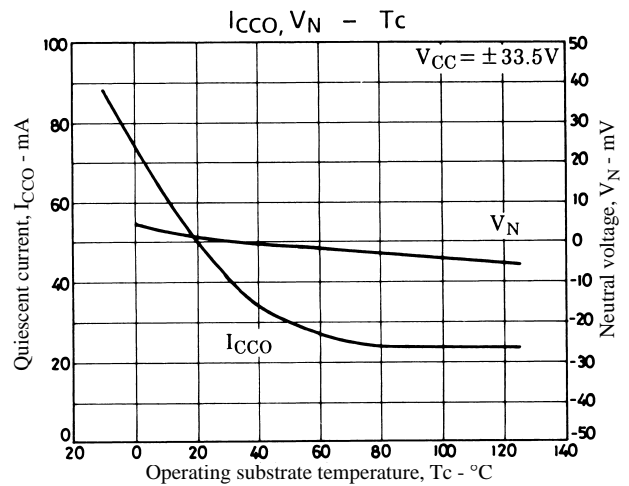
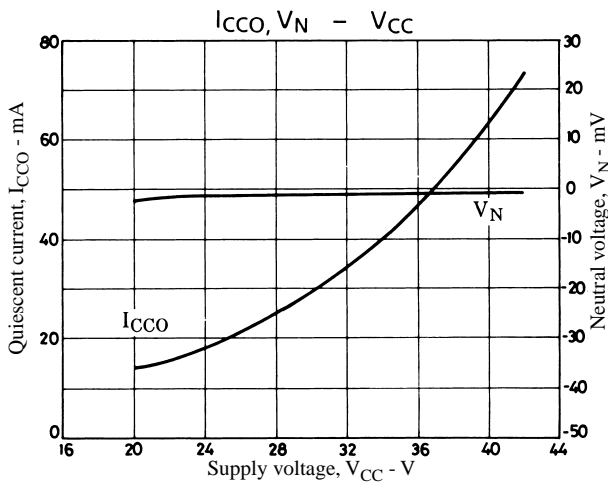
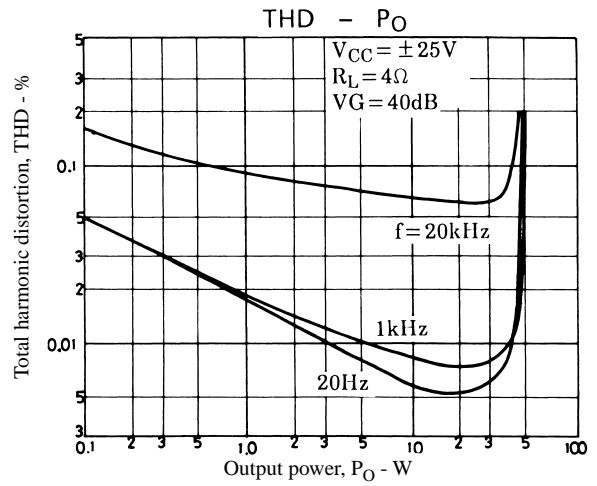
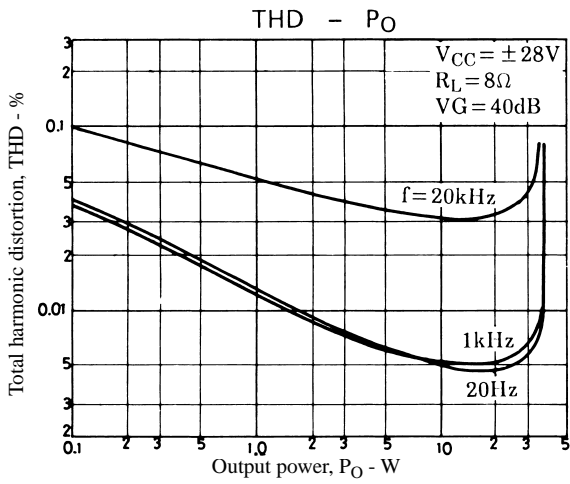
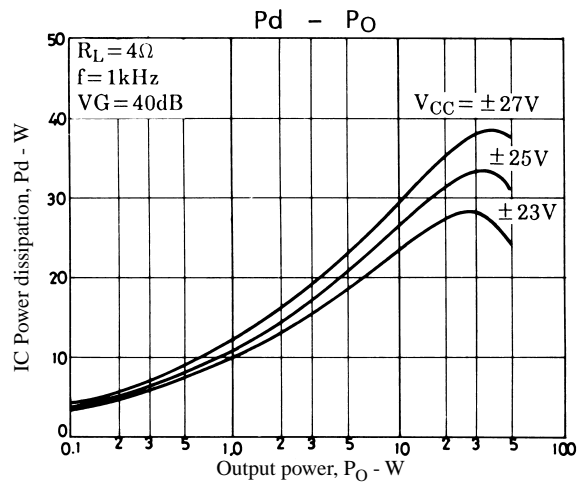
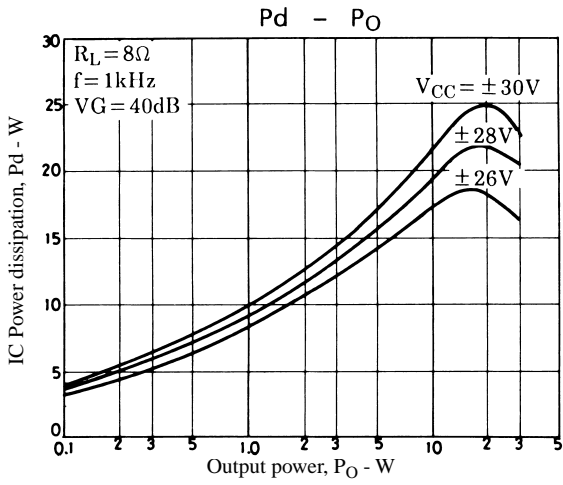

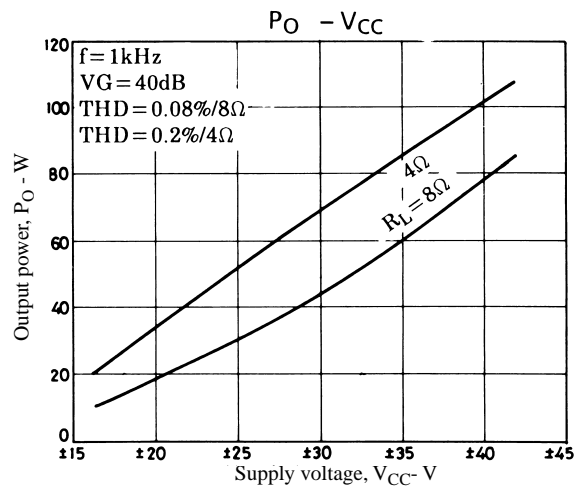
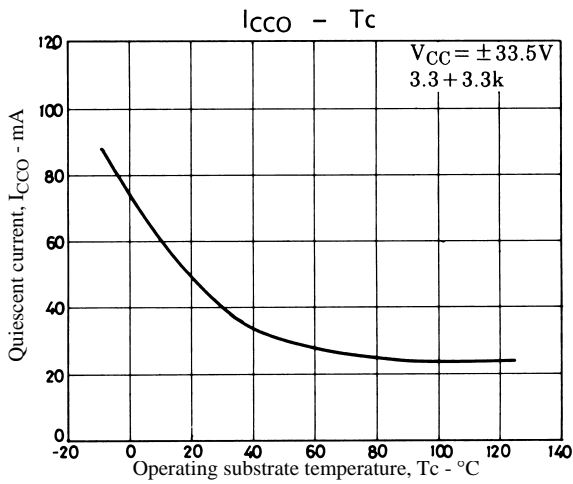

- No products described or contained herein are intended for use in surgical implants, life-support systems, aerospace equipment, nuclear power control systems, vehicles, disaster/crime-prevention equipment and the like, the failure of which may directly or indirectly cause injury, death or property loss.
- Anyone purchasing any products described or contained herein for an above-mentioned use shall:
  - ① Accept full responsibility and indemnify and defend SANYO ELECTRIC CO., LTD., its affiliates, subsidiaries and distributors and all their officers and employees, jointly and severally, against any and all claims and litigation and all damages, cost and expenses associated with such use:
  - ② Not impose any responsibility for any fault or negligence which may be cited in any such claim or litigation on SANYO ELECTRIC CO., LTD., its affiliates, subsidiaries and distributors or any of their officers and employees, jointly or severally.
- Information (including circuit diagrams and circuit parameters) herein is for example only; it is not guaranteed for volume production. SANYO believes information herein is accurate and reliable, but no guarantees are made or implied regarding its use or any infringements of intellectual property rights or other rights of third parties.

This catalog provides information as of June, 1997. Specifications and information herein are subject to change without notice.