

**LA4261**

## 3.5 W 2-Channel AF Power Amplifier for Home Stereos and Music Centers

### Features

- Minimum number of external parts required (No input capacitor, bootstrap capacitor required).
- High output: 3.5 W typ.  $\times 2$ .
- Soft clip, causing little harmonic disturbance to radios (See page 8).
- Small pop noise at the time of power switch ON/OFF (See page 8).
- Built-in protector against abnormal modes (Thermal shutdown, overvoltage).

### Package Dimensions

**3018A-SIP10F**

unit : mm

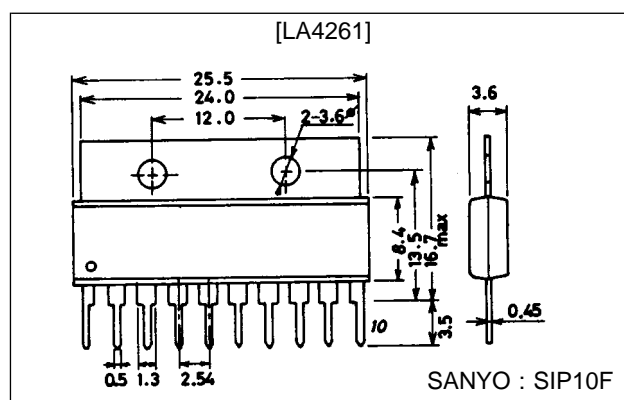

### Specifications

#### Maximum Ratings at $T_a = 25^\circ\text{C}$

Parameter	Symbol	Conditions	Ratings	Unit
Maximum supply voltage	$V_{CCmax}$		25	V
Maximum output current	$I_{OP}$	1 channel	2.0	A
Allowable power dissipation	$P_d \text{ max}$	With heat sink (see $P_d - T_a$ characteristics)	7.5	W
Operating temperature	$T_{opr}$		-20 to +75	$^\circ\text{C}$
Storage temperature	$T_{stg}$		-40 to +150	$^\circ\text{C}$

#### Operating Conditions at $T_a = 25^\circ\text{C}$

parameter	Symbol	Conditions	Ratings	Unit
Recommended supply voltage	$V_{CC}$		16	V
Recommended load resistance	$R_L$		8	$\Omega$
Operating supply voltage range	$V_{CC \text{ op}}$		9 to 24	V

# LA4261

Operating Characteristics at  $T_a = 25^\circ\text{C}$ ,  $V_{CC} = 16\text{ V}$ ,  $R_L = 8\ \Omega$ ,  $f = 1\text{ kHz}$ ,  $R_g = 600\ \Omega$ , (circuit 1)

Parameter	Symbol	Conditions	min	typ	max	Unit
Quiescent current	$I_{CCO}$			46	62	mA
Voltage gain	VG		48	50	52	dB
Output power	$P_O$	THD = 10%	3.0	3.5		W
Total harmonic distortion	THD	$P_O = 0.5\text{ W}$		0.3	1.0	%
Output noise voltage	$V_{NO}$	$R_g = 10\text{ k}\Omega$ , BW = 20 Hz to 20 kHz		0.65	1.5	mV
Ripple rejection ratio	Rr	$R_g = 0$ , $V_r = 500\text{ mV}$	40	50		dB
Crosstalk	CT	$R_g = 10\text{ k}\Omega$	40	55		dB
Voltage gain difference	$\Delta VG$				1.5	dB

## Equivalent Circuit Block Diagram

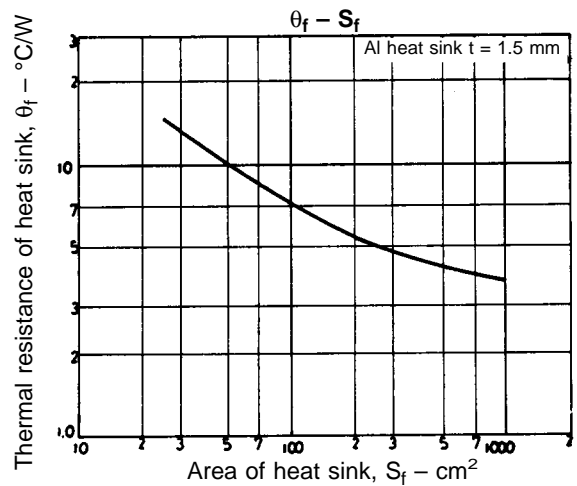
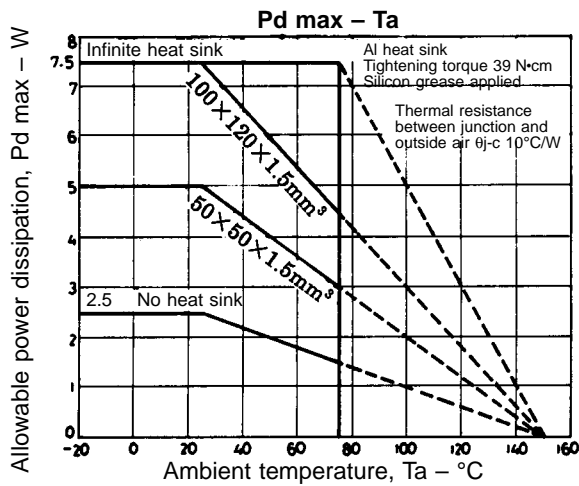
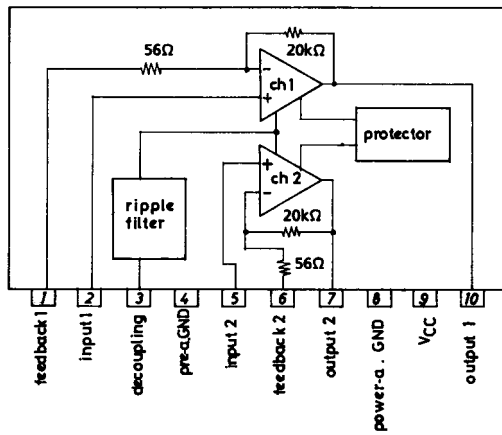

# LA4261

## Sample Application Circuit 1: Recommended Circuit

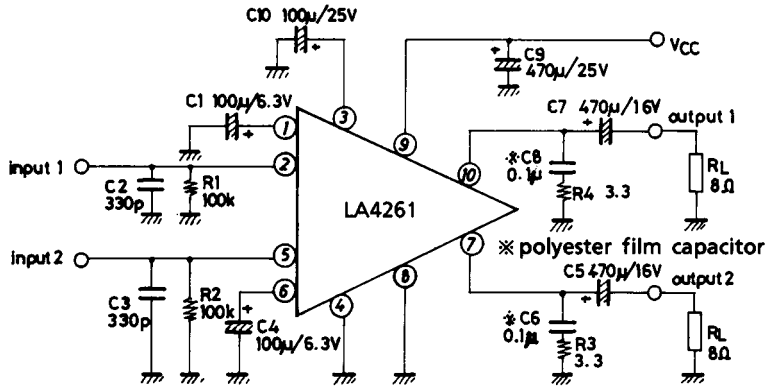

## Sample Application Circuit 2: Circuit with minimum number of external parts

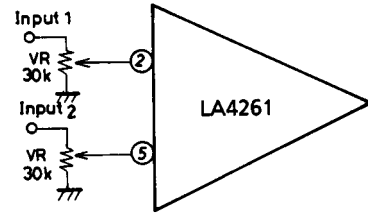

Unit (resistance: Ω, capacitance: F)

## Sample Printed Circuit Pattern

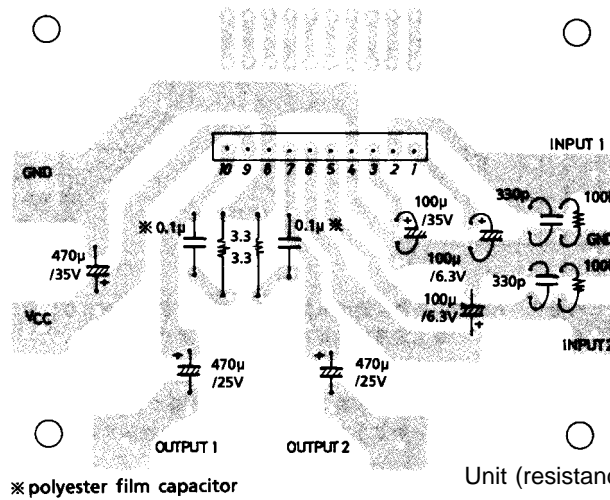

Unit (resistance: Ω, capacitance: F)

## Description of External Parts

C1, C4	100 μF	Feedback capacitor Decreasing the capacitance value lowers the low frequency response. Increasing the capacitance value makes the starting time later.
C2, C3	330 pF	Input short capacitor Reduces the high frequency noise when the input impedance is increased. Not required when the input impedance is decreased.
C5, C7	470 μF	Output capacitor Decreasing the capacitance value causes insufficient power at low frequencies.
C6, C8	0.1 μF polyester film capacitor	Oscillation blocking capacitor Decreasing the capacitance value causes oscillation to occur easily. Use a polyester film capacitor that is good in high frequency response and temperature characteristic. The use of an electrolytic capacitor may cause oscillation to occur at low temperatures.
C9	470 μF	Power capacitor Decreasing the capacitance value causes ripple to occur. Locating at a distance from the IC or removing this capacitor may cause oscillation to occur.
C10	100 μF	Ripple filter capacitor Decreasing the capacitance value excessively or removing this capacitor causes ripple to occur. However, increasing the capacitance value does not always cause ripple to be reduced. Decreasing the capacitance value makes the starting time earlier.
R1, R2	100 kΩ	Input bias resistor Determines the bias (bias of GND potential) to be applied to the input pin and the input impedance. Not required if variable resistors are used.
R3, R4	3.3 Ω	Resistor connected in series with oscillation blocking capacitor. Prevents phase shift attributable to the oscillation blocking capacitor so that oscillation is hard to occur.

**Note for Changing Voltage Gain**

Basically, the voltage gain can be reduced by adding external resistors ( $R_{NF}$ ) in series with feedback capacitors  $C1$ ,  $C4$ . However, it should be noted that since there is no phase compensation pin the frequency response is extended and oscillation is liable to occur when the voltage gain is reduced. The voltage gain must not be reduced to be less than 30 dB.

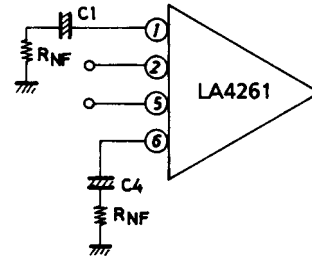

**External Muting**

If external muting is required, make the circuit as shown right. In this case, the attack time, recovery time, and pop noise are similar to those which occur at the time of power switch ON/OFF.

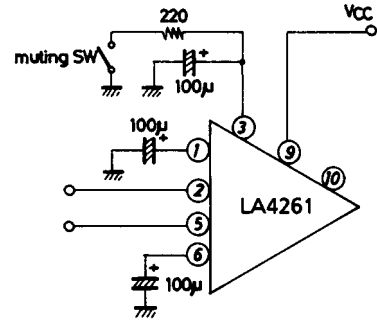

Unit (resistance:  $\Omega$ , capacitance: F)

**Proper Cares in Using IC**

- Maximum ratings  
If the IC is used in the vicinity of the maximum ratings, even a slight variation in conditions may cause the maximum ratings to be exceeded, thereby leading to breakdown. Allow an ample margin of variation for supply voltage, etc. and use the IC in the range where the maximum ratings are not exceeded.
- Pin-to-pin short  
If power is applied when the space between pins is shorted, breakdown or deterioration may occur. When mounting the IC on the board or applying power, make sure that the space between pins is not shorted with solder, etc.
- When using in radios, allow a sufficient space between IC and bar antenna.
- Printed circuit pattern  
When designing the printed circuit pattern, make the power supply, output, and ground lines thick and short and arrange the pattern and parts so that no feedback loop is formed between input and output. Place power capacitor  $C9$ , oscillation blocking capacitors  $C6$ ,  $C8$  as close to IC pins as possible to prevent oscillation from occurring. Refer to the sample printed circuit pattern.

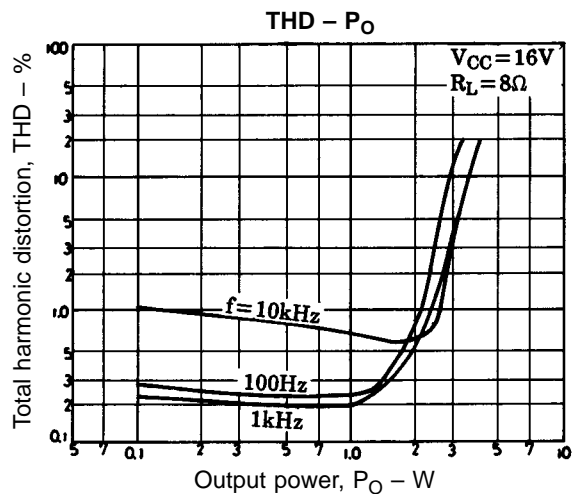
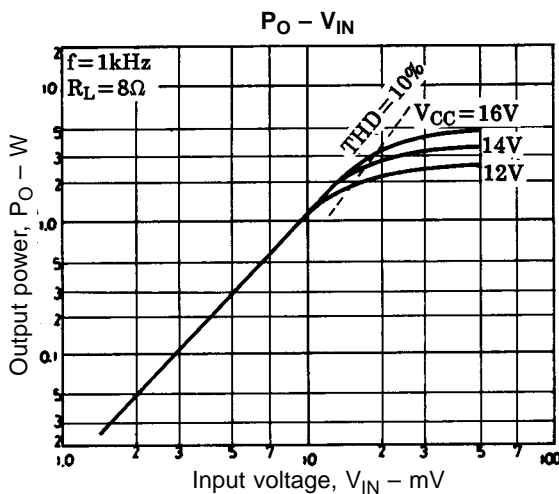

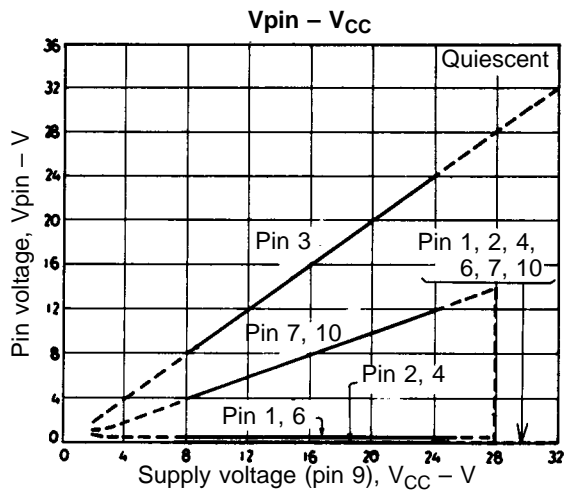
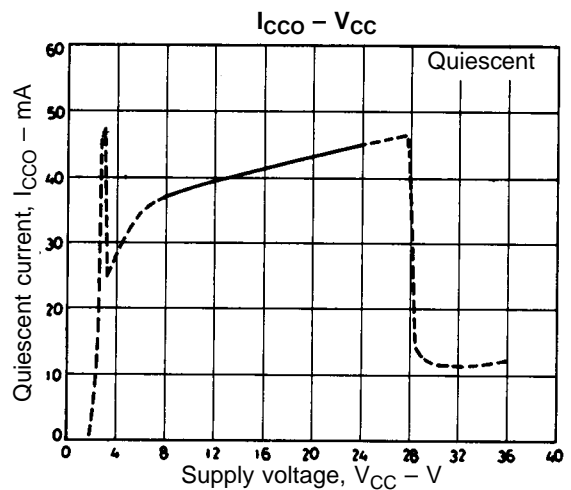
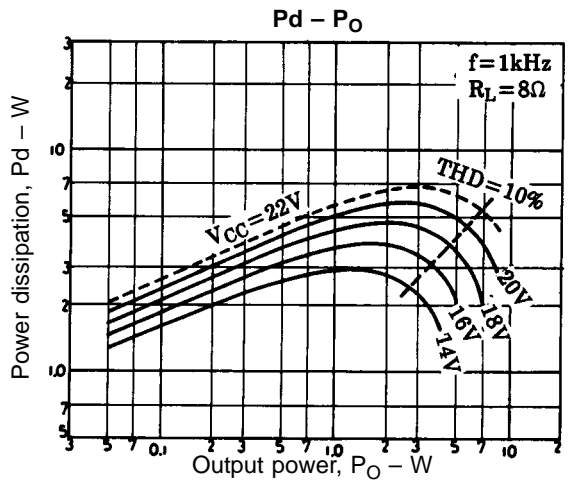
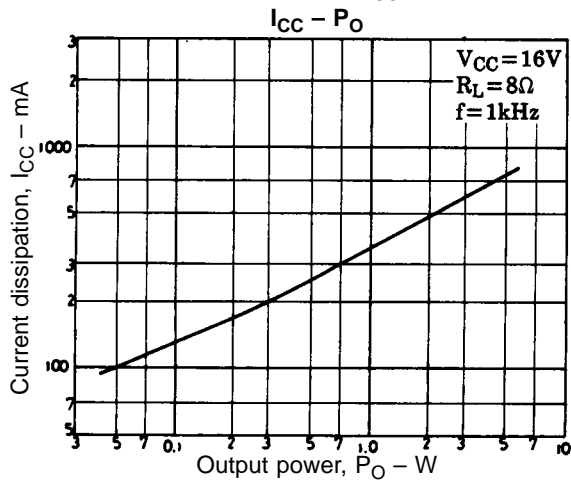
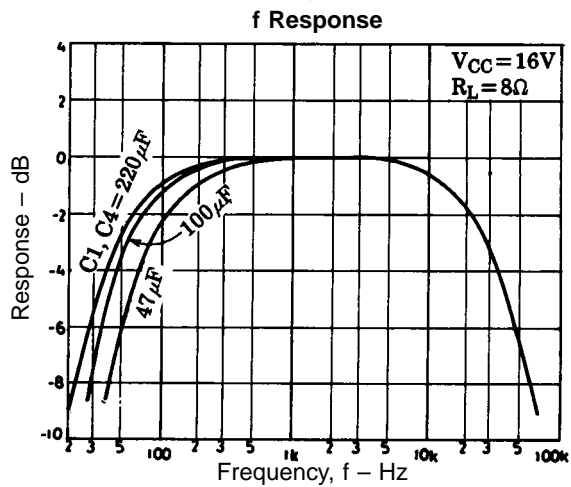
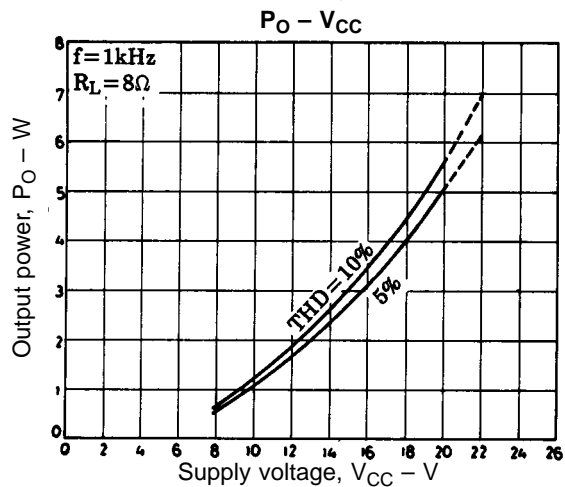
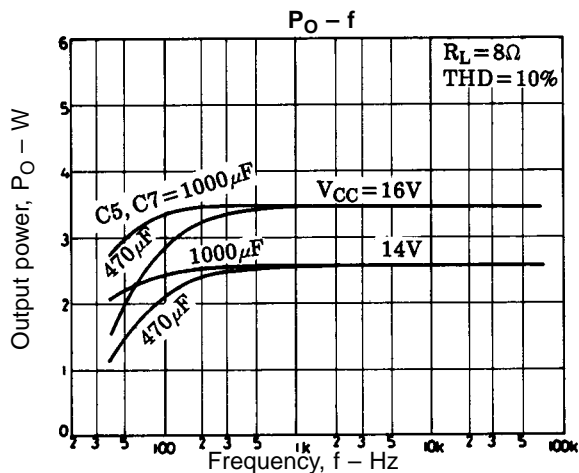
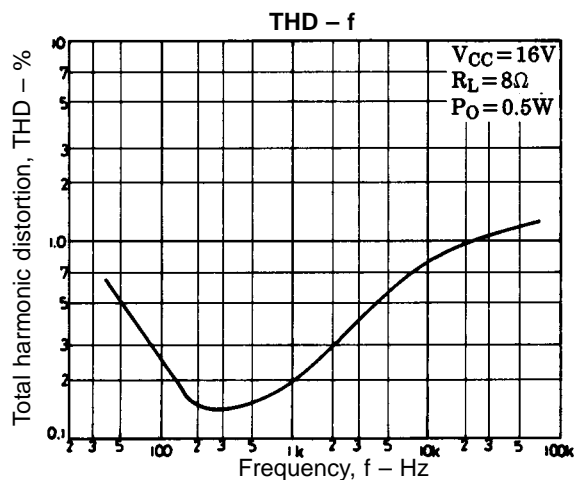

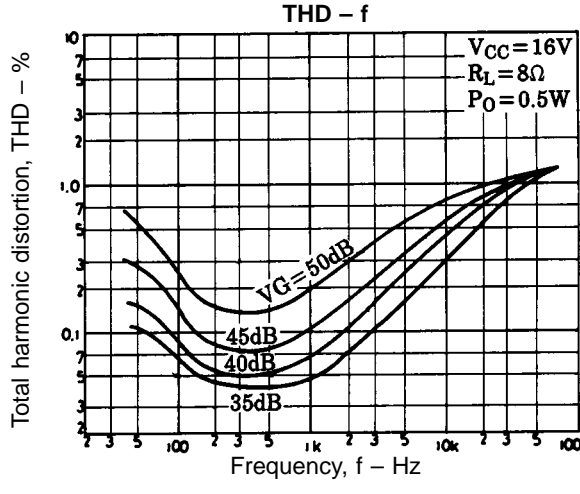
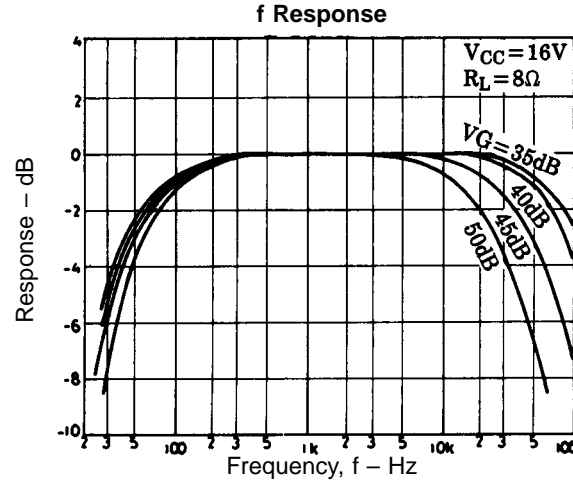
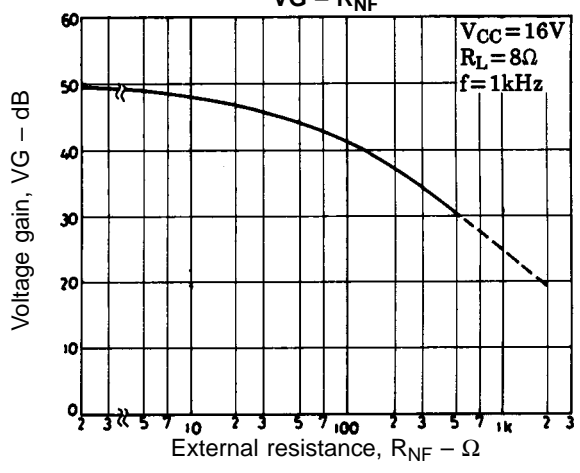
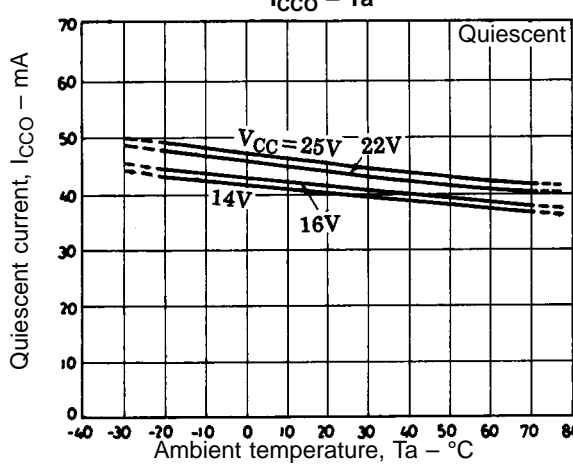
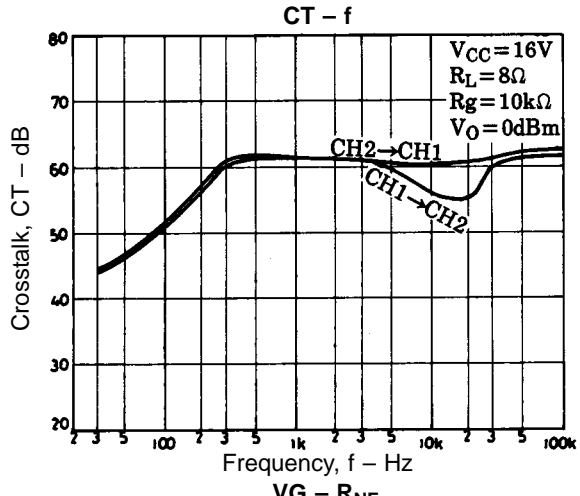
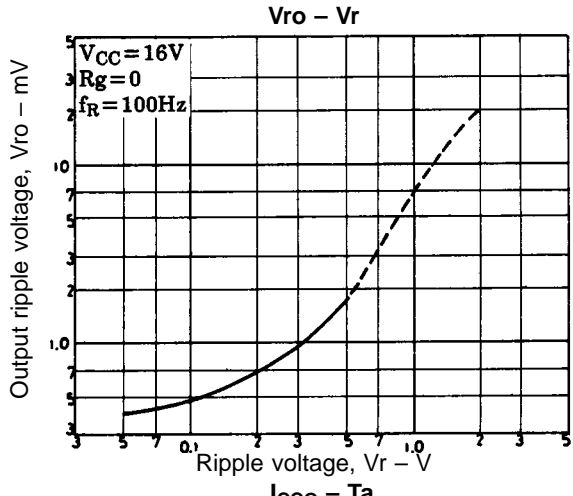
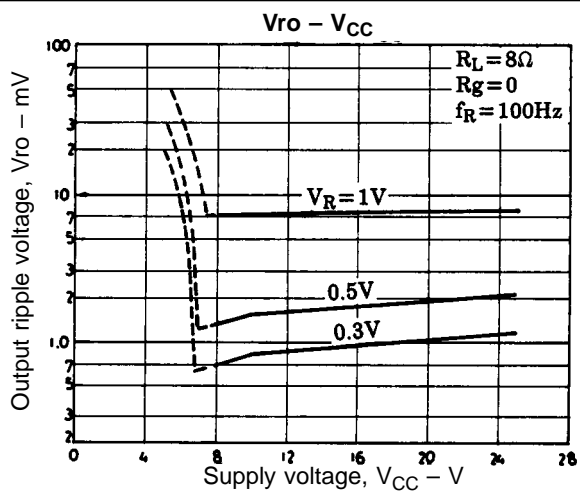
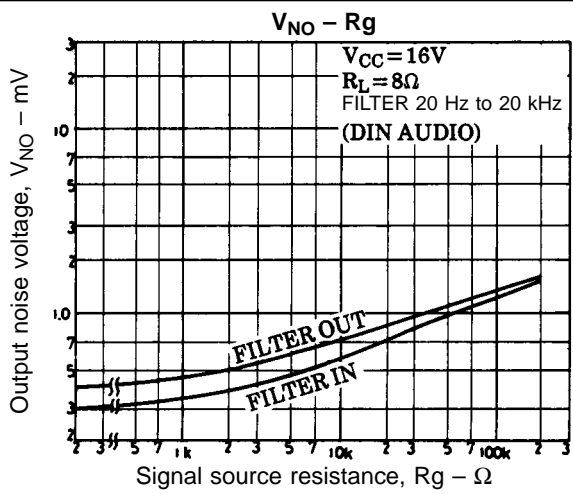

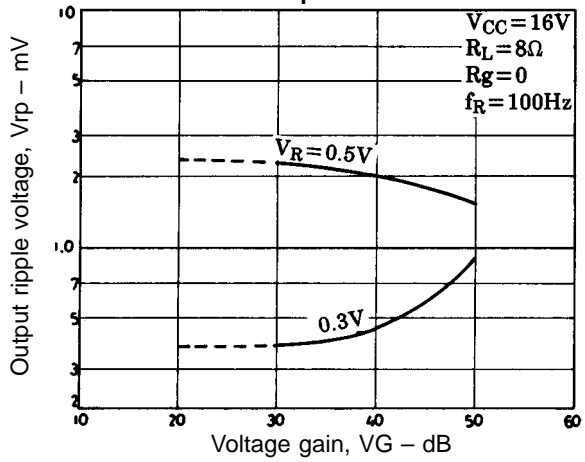
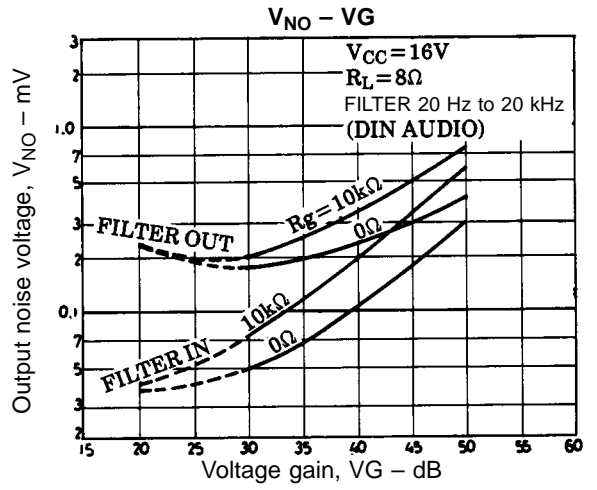
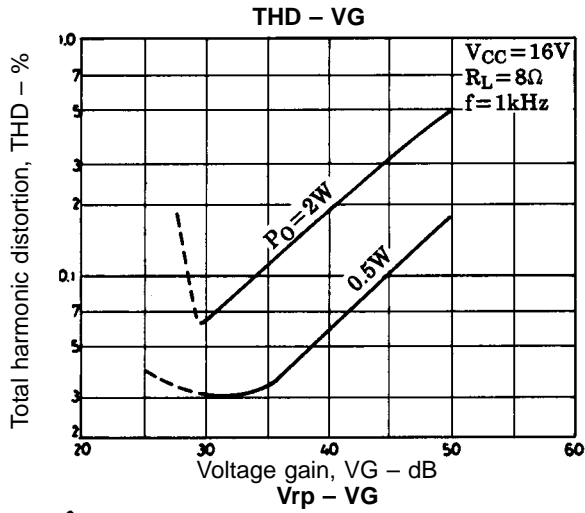

Pop Noise Waveform at The Time of Power Switch ON  
( $V_{CC} = 16\text{ V}$ ,  $R_L = 8\ \Omega$ , quiescent)

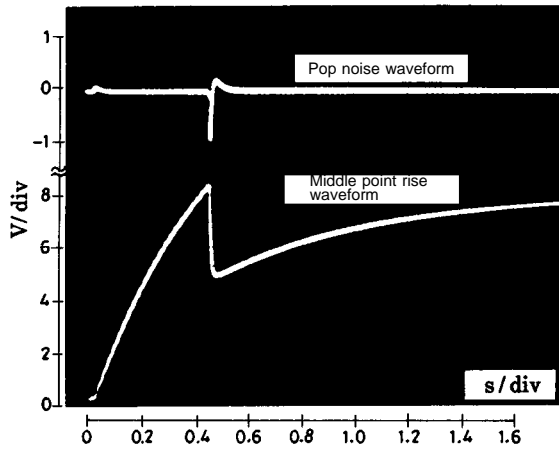

f = 1 kHz Clip waveform  
( $V_{CC} = 16\text{ V}$ ,  $R_L = 8\ \Omega$ , THD = 5%)

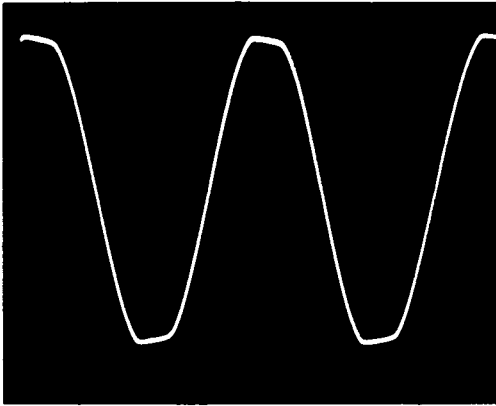

Pop Noise Waveform at The Time of Power Switch OFF  
( $V_{CC} = 16\text{ V}$ ,  $R_L = 8\ \Omega$ , quiescent)

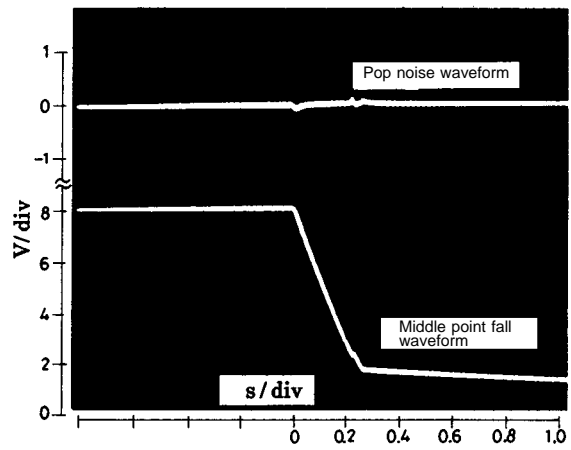

f = 10 kHz Clip waveform  
( $V_{CC} = 16\text{ V}$ ,  $R_L = 8\ \Omega$ , THD = 5%)

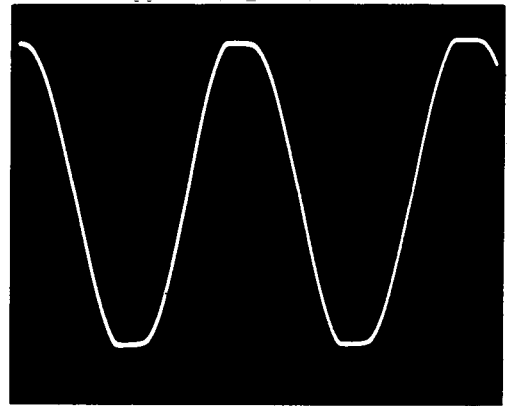

- No products described or contained herein are intended for use in surgical implants, life-support systems, aerospace equipment, nuclear power control systems, vehicles, disaster/crime-prevention equipment and the like, the failure of which may directly or indirectly cause injury, death or property loss.
- Anyone purchasing any products described or contained herein for an above-mentioned use shall:
  - ① Accept full responsibility and indemnify and defend SANYO ELECTRIC CO., LTD., its affiliates, subsidiaries and distributors and all their officers and employees, jointly and severally, against any and all claims and litigation and all damages, cost and expenses associated with such use:
  - ② Not impose any responsibility for any fault or negligence which may be cited in any such claim or litigation on SANYO ELECTRIC CO., LTD., its affiliates, subsidiaries and distributors or any of their officers and employees jointly or severally.
- Information (including circuit diagrams and circuit parameters) herein is for example only; it is not guaranteed for volume production. SANYO believes information herein is accurate and reliable, but no guarantees are made or implied regarding its use or any infringements of intellectual property rights or other rights of third parties.

This catalog provides information as of February 1997. Specifications and information herein are subject to change without notice.