



## Overview

Being developed for FM IF System, LA1231 is a highly integrated circuit in which almost all functions are contained concerning the FM tuner IF stage. The block diagram of equivalent circuit is shown below. Usual peripheral circuits are shown also in examples of application circuits.

The IF amplifier and limiter stages are composed of 6-stage double-end type differential amplifier, which is superior on its AMR. The signal meter driving stage which is located in parallel therewith consists of a 3-stage level detector circuit and a drive circuit in order to extend the linear area.

The FM detection stage composed of a double-balance type

quadrature detecting circuit is attached with a low frequency preamplifier and muting control circuit.

The muting drive stage is composed of the following 3 circuits.

- 1) A level detection circuit which detects the S/N ratio of carrier wave when the input is weak.
- 2) A circuit which detects the dc output of FM detector's 'S' curve when detuning is made.
- 3) A driving circuit.

Thus, this muting driving stage can reduce foreign factors such as the interstation noises, the shock noise caused from muting when detuning is made, and so forth.

Besides, a voltage-inverting circuit is built in LA1231N so that the muting may be enabled at any appropriate input signal level. The output of this voltage-inverting circuit is connected with the muting drive output terminal. Thus, the muting can be placed to the ON or OFF status when a control voltage is applied from other section to the input terminal of the voltage-inverting circuit. For the control voltage, the output of the signal meter driver is appropriate. Both the AFC output stage and tuning meter driving stage are of the current-driven type. So, not only the sensitivity of AGC but also the muting band (when detuning is made) can be controlled by an outer resistor.

Being utilized for disabling the FM IF amplifier when AM reception is made, the IF amplification/stop circuit can decrease the shock noise caused at the conversion between FM and AM reception modes.

## Functions

- IF amplification, Limiter.
- AF preamplifier.
- Muting at the detuning.
- AFC tuning meter drive output.
- Inverting circuit for muting drive voltage.
- Quadrature detection.
- Muting at weak.
- Signal meter drive output.
- Delay AGC output.
- IF amplifier stop circuit.

## Package Dimensions

unit: mm

### 3006B-DIP16

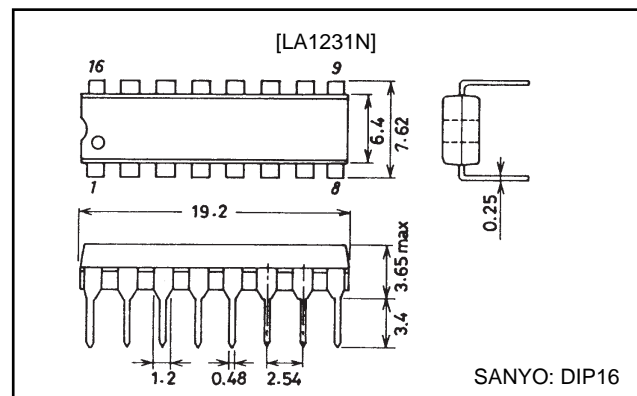

**Features**

- High sensitivity on limiting : 18 $\mu$ V typ.
- Low distortion : 0.05% typ. determined by the linearity of phase characteristics in phase shifting circuit.
- High demodulation output : 330 mVrms typ.
- High S/N ratio : 78.5dB typ.
- Muting at detuning with little shock noise.
- Single meter drive output proportional with the input signal level dB.
- Detuning muting band having good symmetrics.
- Tuning meter driving output having wide swing width.
- Delay AGC drive output for front end.
- Constant voltage circuit is built-in : operation voltage=9 to 14V.
- Muting characteristics between adjacent stations are distinguished.

**Equivalent Circuit Block Diagram**

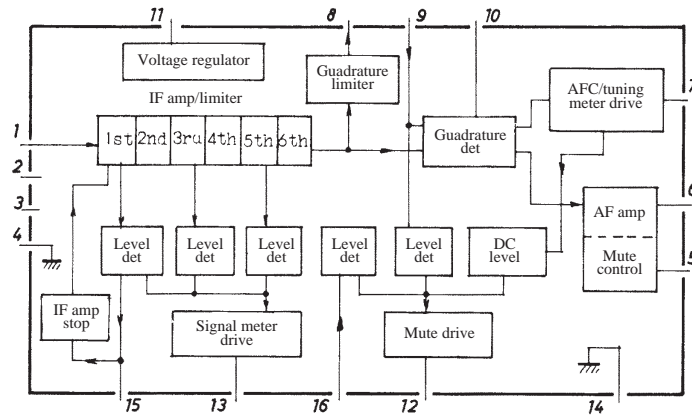

**Specifications**

**Maximum Ratings** at Ta=25°C

Parameter	Symbol	Conditions	Ratings	Unit
Maximum supply voltage	V <sub>CCmax</sub>	Pin 11	16	V
Maximum input voltage	V <sub>IN</sub>	Pins 1-2	±1	Vp-p
Maximum supply current	I <sub>CC</sub>	Pin 11	40	mA
Maximum flow-in current	I <sub>15</sub>	Pin 15	1	mA
	I <sub>16</sub>	Pin 16	1	mA
Maximum flow-out current	I <sub>10</sub>	Pin 10	2	mA
	I <sub>12</sub>	Pin 12	2	mA
	I <sub>13</sub>	Pin 13	2	mA
	I <sub>15</sub>	Pin 15	2	mA
Allowable power dissipation	P <sub>d max</sub>		650	mA
Operating temperature	T <sub>opr</sub>		-20 to +70	°C
Storage temperature	T <sub>stg</sub>		-40 to +125	°C

## LA1231N

### Recommended Operating Conditions at Ta=25°C

Parameter	Symbol	Conditions	Ratings	Unit
Supply voltage	V <sub>CC</sub>		12	V

### Operating Characteristics at Ta=25°C, V<sub>CC</sub>=12V, f=10.7MHz

Parameter	Symbol	Conditions	Ratings			Unit
			min	typ	max	
Quiescent current	I <sub>CCO</sub>			22	30	mA
Current drain	I <sub>CC</sub>	V <sub>IN</sub> =100dBμ		26.5	33	mA
Demodulated output	V <sub>o</sub>	V <sub>IN</sub> =100dBμ, 400Hz-100% mod	240	330	460	mVrms
S/N		V <sub>IN</sub> =100dBμ, 400Hz-100% mod	72	78.5		dB
Input limiting voltage	V <sub>IN(lim)</sub>	V <sub>o</sub> 3dB down, 400Hz-100% mod		25	31	dBμ
Total harmonic distortion	THD	V <sub>IN</sub> =100dBμ, 400Hz-100% mod		0.05	0.3	%
Muting sensitivity	V <sub>IN(mute)</sub>	V <sub>12</sub> =1.4V	23	29	35	dBμ
Muting attenuation	Mute(att)	V <sub>5</sub> =2V, V <sub>IN</sub> =100dBμ, 400Hz-100% mod	60	65		dB
Muting bandwidth	BW(mute)	V <sub>IN</sub> =100dBμ, V <sub>12</sub> =1.4V	140	220	370	kHz
AM rejection ratio	AMR	V <sub>IN</sub> =100dBμ, FM : 400Hz-100% mod AM : 1kHz-30% mod	45	60		dB
Muting driving output	V <sub>12</sub>	Quiescent	4.0	4.9	6.0	V
		V <sub>IN</sub> =100dBμ	0	0	0.3	V
Signal meter driving output	V <sub>13</sub>	Quiescent	0	0	0.1	V
		V <sub>IN</sub> =70dBμ	1.9	3.0	4.2	V
		V <sub>IN</sub> =100dBμ	4.5	5.5		V
AGC output	V <sub>15</sub>	Quiescent	4.2	5.0	5.5	V
		V <sub>IN</sub> =100dBμ	0	0	0.5	V
IF off current	I <sub>15(off)</sub>	Quiescent, V <sub>8-10</sub> ≤20mV	10	35	60	μA
Voltage of muting operation	V <sub>16(mute)</sub>	V <sub>IN</sub> =100dBμ, V <sub>12</sub> =1.4V	0.7	0.84	1.0	V
Offset voltage	V <sub>6-10 B</sub>	Quiescent, pin 6-10	-0.5	0	+0.5	V
	V <sub>7-10 B</sub>	Quiescent, pin 7-10, R <sub>7-10</sub> =5.1kΩ	-0.25	0	+0.25	V
Pin voltage	V <sub>1</sub>	Quiescent		2.6		V
	V <sub>2</sub>	Quiescent		2.6		V
	V <sub>3</sub>	Quiescent		2.6		V
	V <sub>6</sub>	Quiescent		5.6		V
	V <sub>7</sub>	Quiescent		5.6		V
	V <sub>8</sub>	Quiescent		5.4		V
	V <sub>10</sub>	Quiescent		5.6		V
	V <sub>12</sub>	Quiescent		4.9		V
	V <sub>13</sub>	Quiescent		0		V
	V <sub>15</sub>	Quiescent		5.0		V

# LA1231N

## Test Circuit

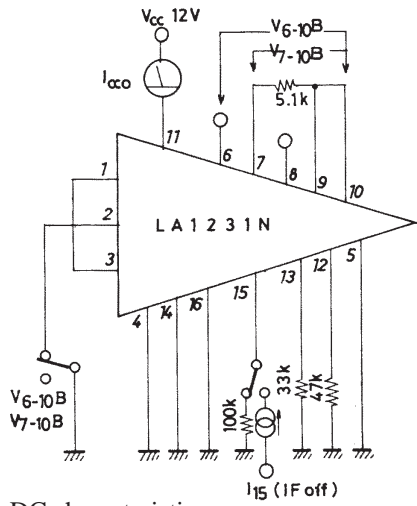
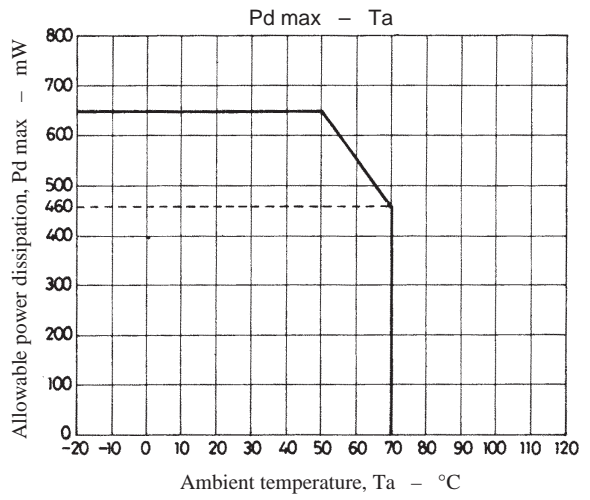

DC characteristics

Unit (resistance :  $\Omega$ , capacitance : F)

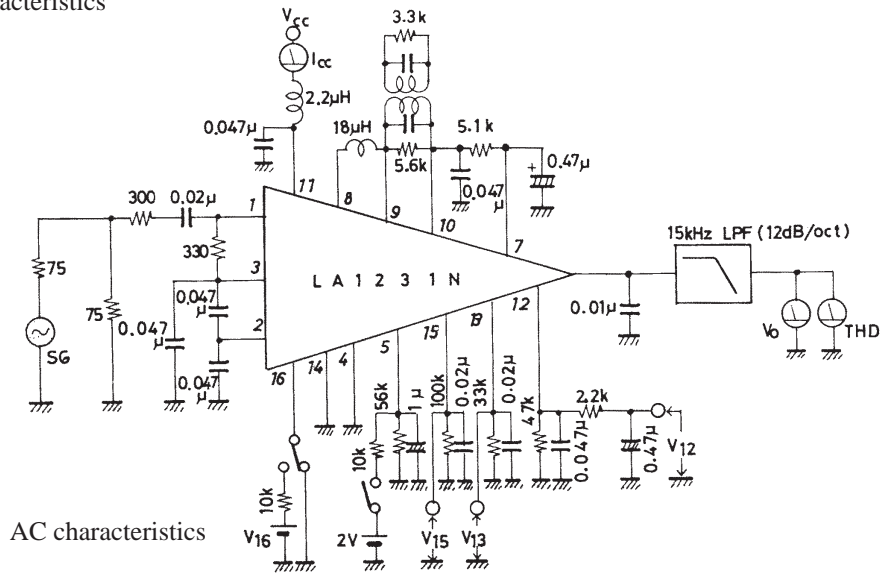

AC characteristics

Unit (resistance :  $\Omega$ , capacitance : F)

Sample Application Circuit

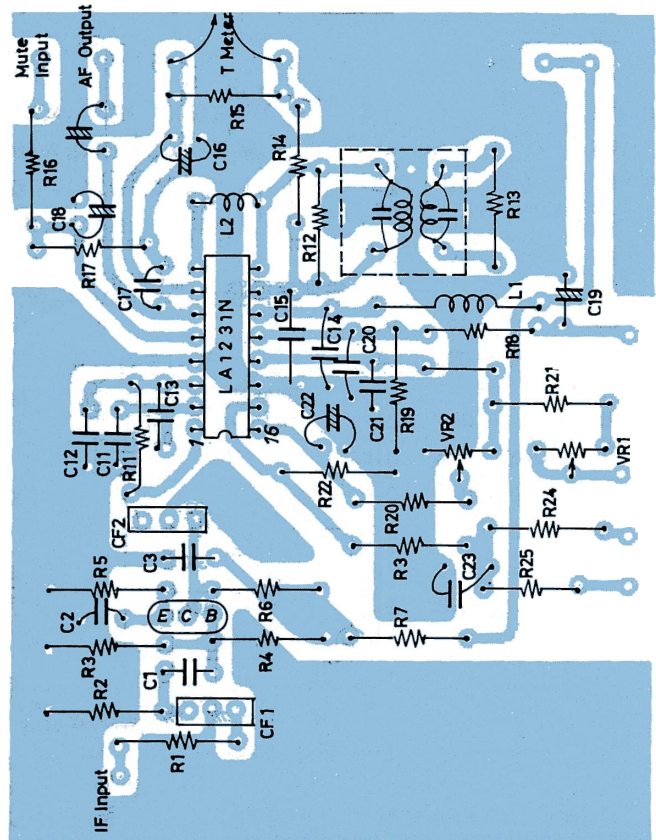
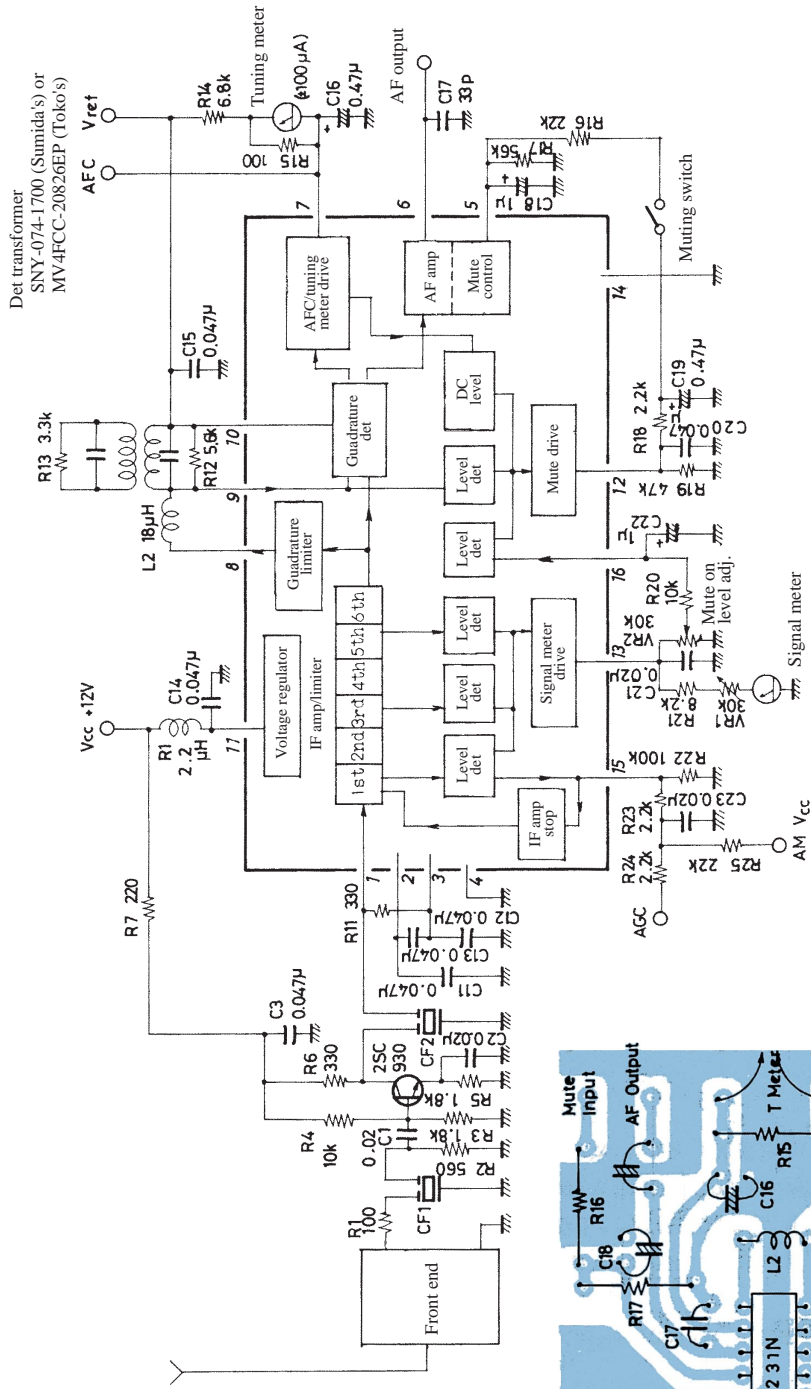

An Example of Printed Pattern Board (70×95mm<sup>2</sup>, bottom view)

Unit (resistance : Ω, capacitance : F)

# LA1231N

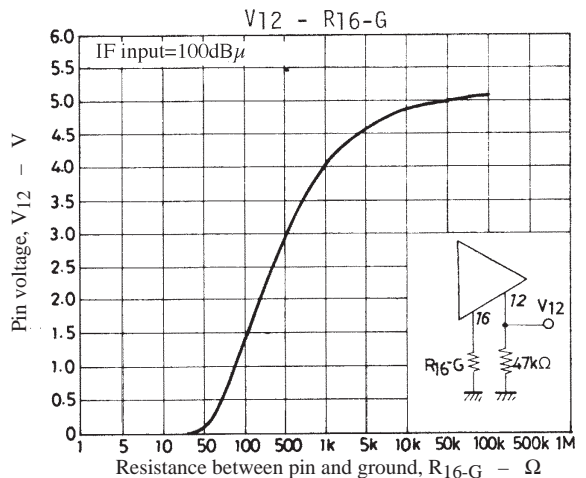
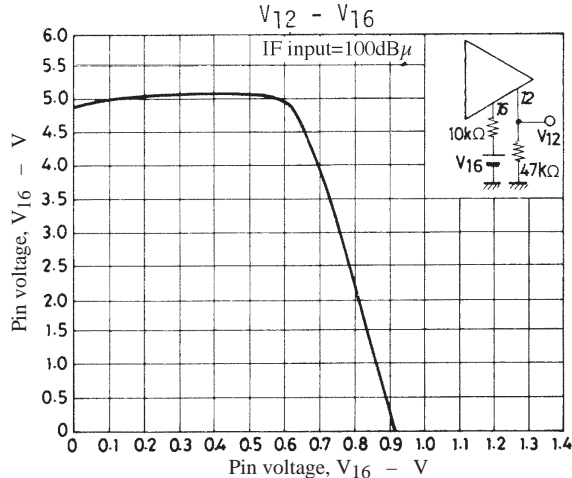
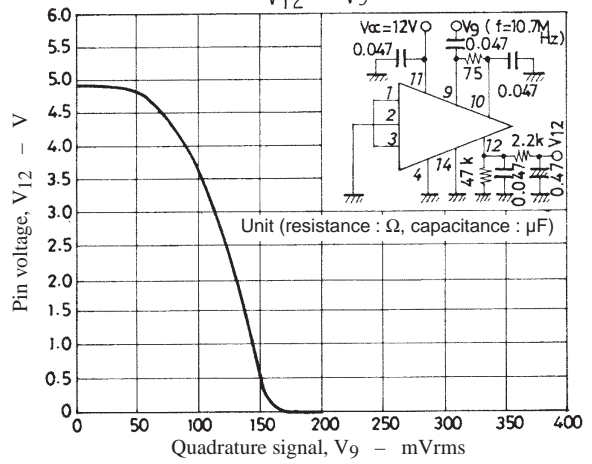
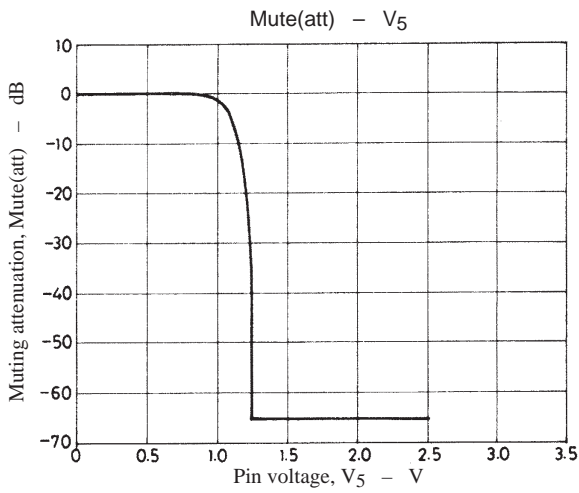
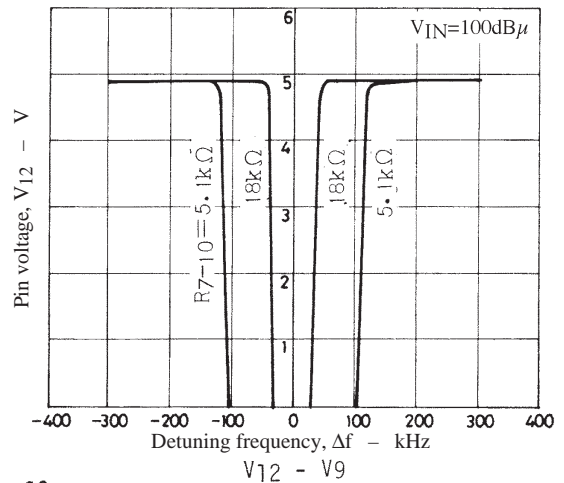
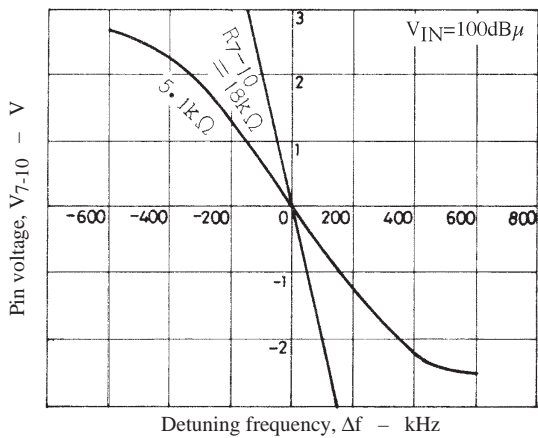
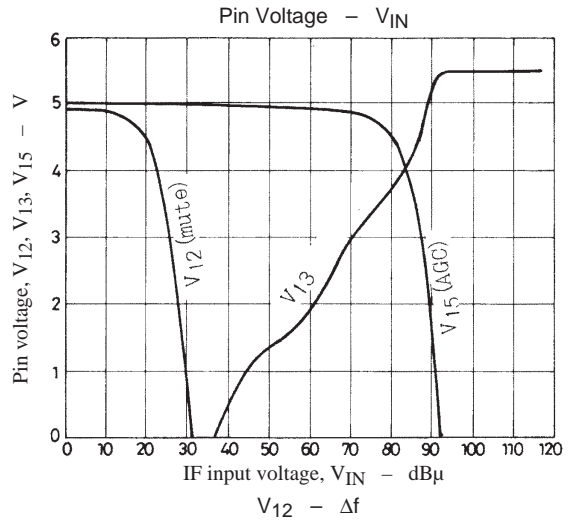
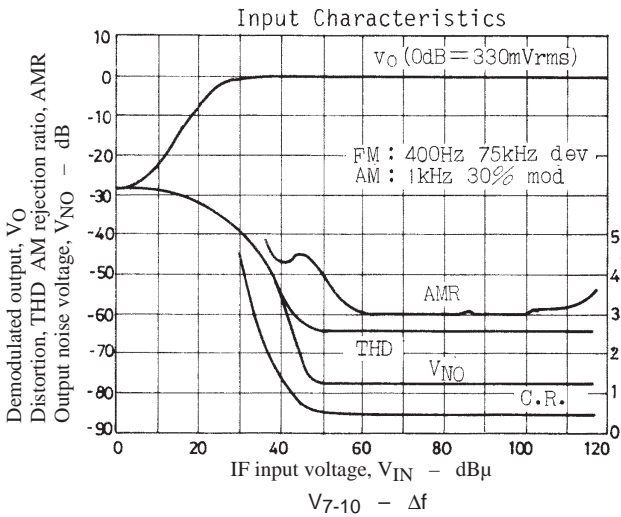

# LA1231N

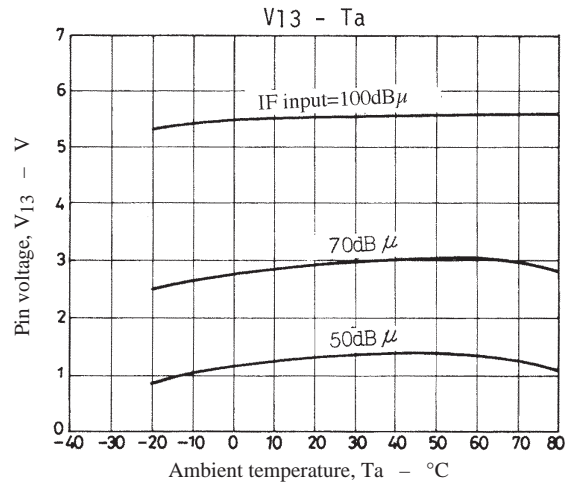
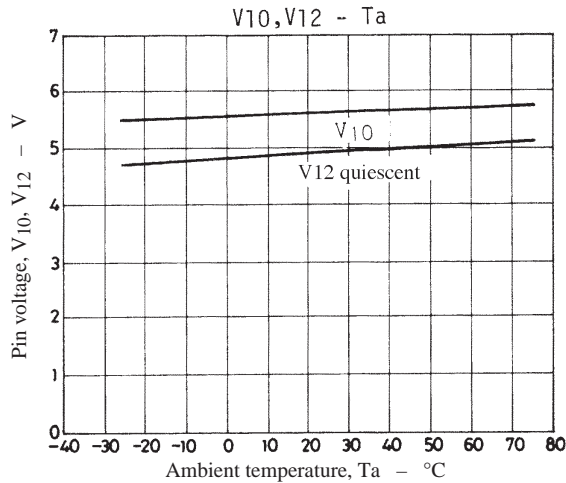
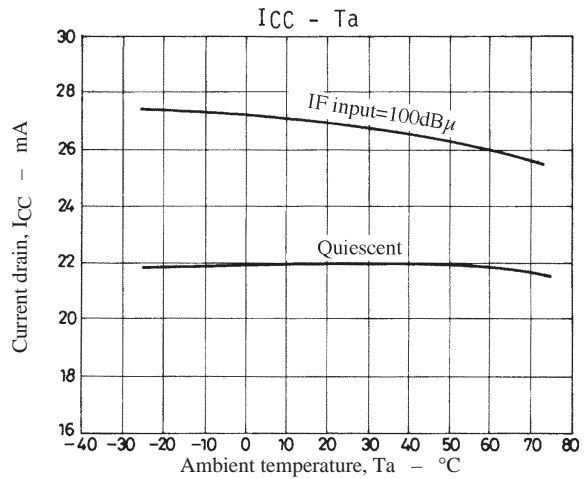
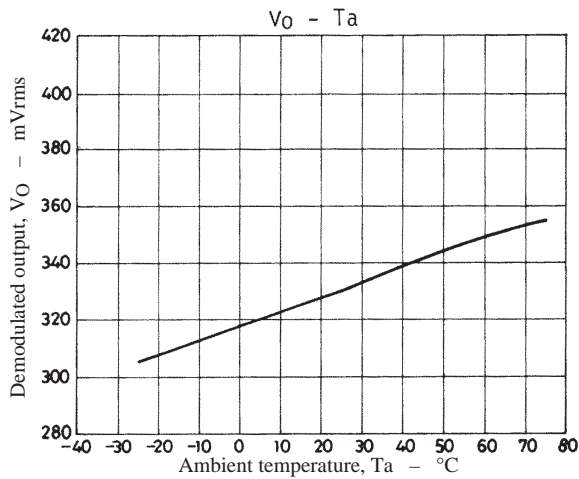
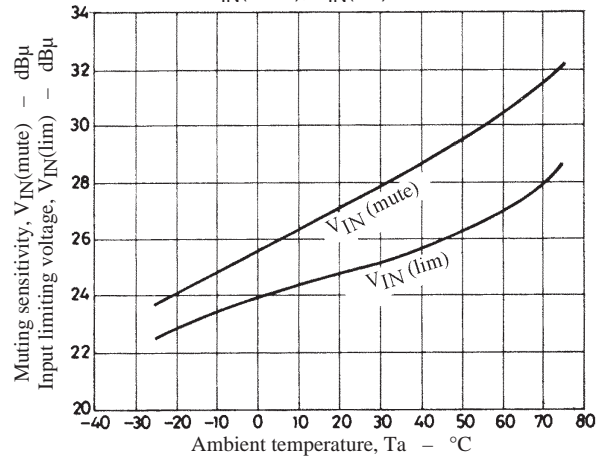
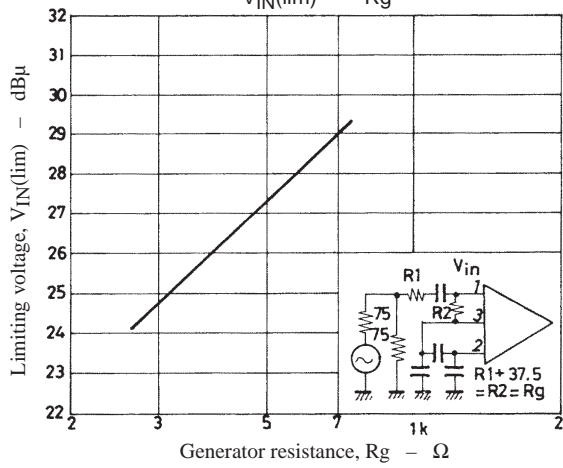
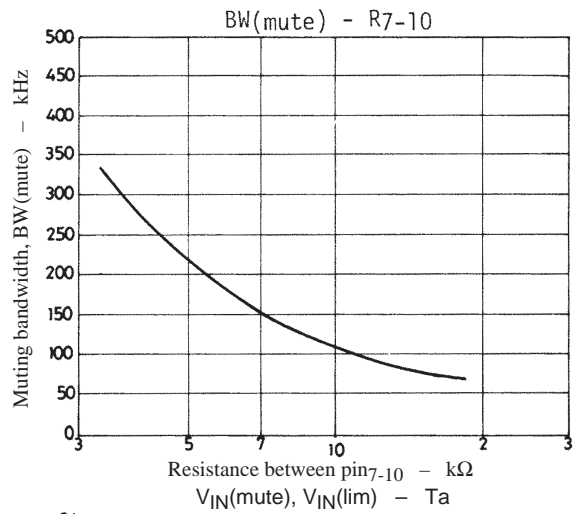
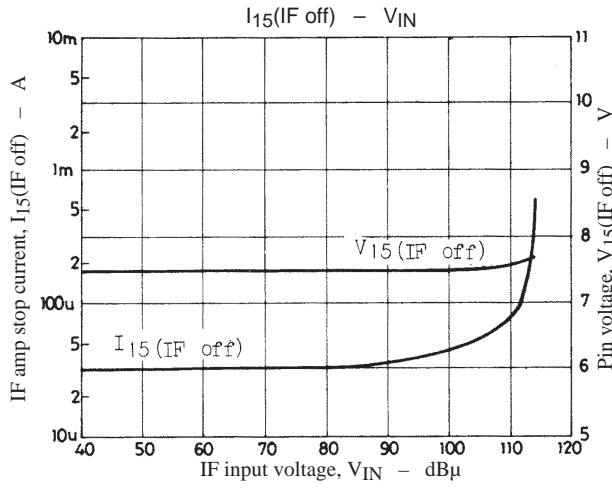

# LA1231N

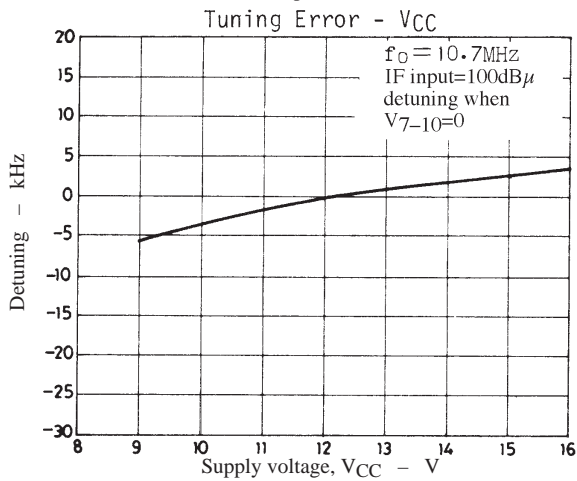
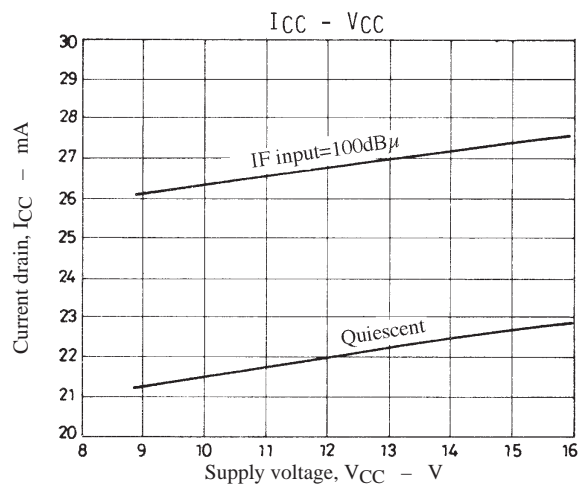
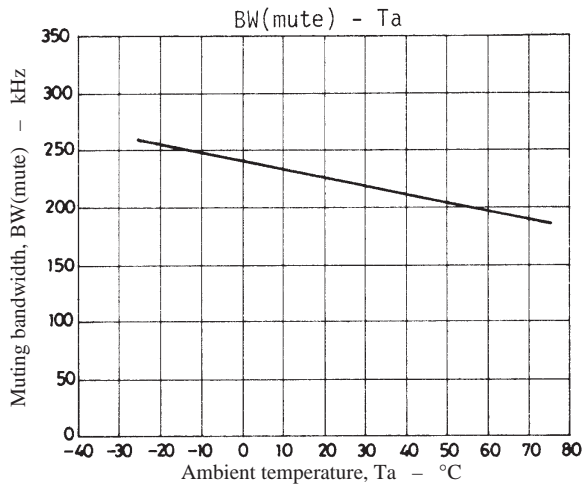
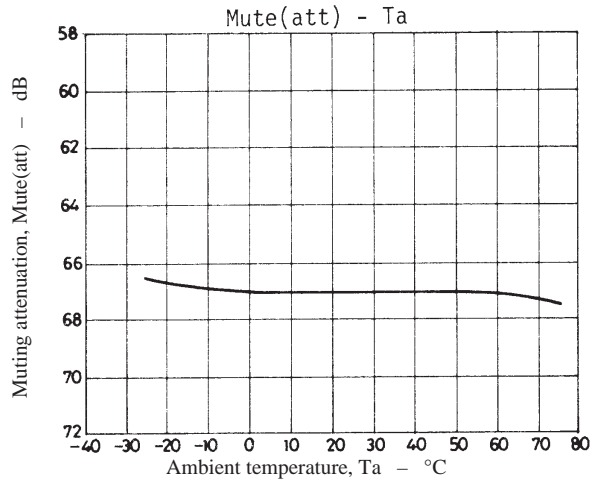
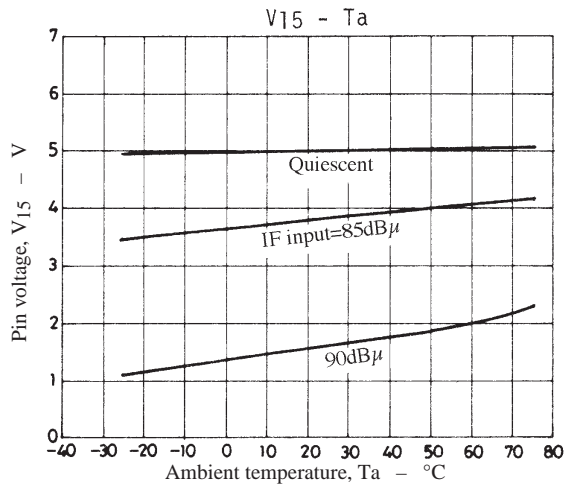

■ No products described or contained herein are intended for use in surgical implants, life-support systems, aerospace equipment, nuclear power control systems, vehicles, disaster/crime-prevention equipment and the like, the failure of which may directly or indirectly cause injury, death or property loss.

■ Anyone purchasing any products described or contained herein for an above-mentioned use shall:

- ① Accept full responsibility and indemnify and defend SANYO ELECTRIC CO., LTD., its affiliates, subsidiaries and distributors and all their officers and employees, jointly and severally, against any and all claims and litigation and all damages, cost and expenses associated with such use:
- ② Not impose any responsibility for any fault or negligence which may be cited in any such claim or litigation on SANYO ELECTRIC CO., LTD., its affiliates, subsidiaries and distributors or any of their officers and employees jointly or severally.

■ Information (including circuit diagrams and circuit parameters) herein is for example only; it is not guaranteed for volume production. SANYO believes information herein is accurate and reliable, but no guarantees are made or implied regarding its use or any infringements of intellectual property rights or other rights of third parties.

This catalog provides information as of October, 1997. Specifications and information herein are subject to change without notice.