

**LA3242**

Preamplifier for Compact Cassette Recorder Recording-only Use

Overview

The LA3242 is a preamp IC for compact cassette recorder recording-only use. The distinctive feature of the LA3242 is that it contains mechanical switches which have been so far connected externally as peripheral parts.

Features

- On-chip electronic select switches permitting selection of normal/higher speed recording and metal(chrome)/normal tape recording mode by using the dedicated control pins.
- Two ALC output pins making it easy to make up a Dolby recording system.
- The control voltage from a microcomputer, etc. can be used to turn ON/OFF the ALC and to set the ALC control voltage to the initial value.
- On-chip microphone amplifier making it easy to provide microphone mixing.
- Wide operating voltage range ($V_{CC} = 4.5$ to 14.0 V).
- Can be used in conjunction with playback-only preamp LA3246 to make up a double-cassette dubbing system.

Package Dimensions

unit : mm

3067-DIP24S

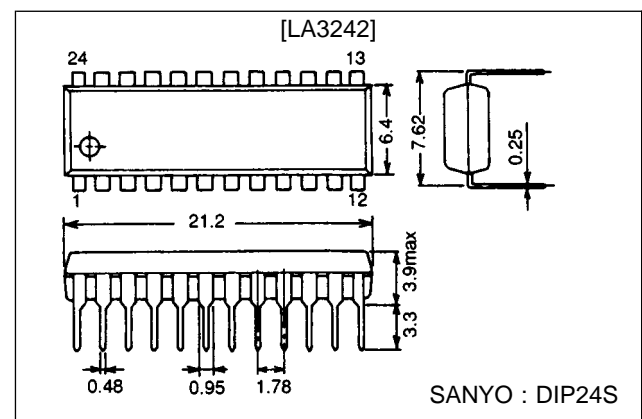

Functions

- Recording preamplifier ×2
- Microphone amplifier ×1
- ALC output ×2
- Electronic switch ×6

Specifications

Maximum Ratings at $T_a = 25^\circ\text{C}$

Parameter	Symbol	Conditions	Ratings	Unit
Maximum supply voltage	V_{CC} max		16	V
Allowable power dissipation	P_d max		720	mW
Operating temperature	T_{op}		-20 to +75	$^\circ\text{C}$
Storage temperature	T_{stg}		-40 to +125	$^\circ\text{C}$

Operating Conditions at $T_a = 25^\circ\text{C}$

Parameter	Symbol	Conditions	Ratings	Unit
Recommended supply voltage	V_{CC}		6	V
Operating voltage range	V_{CC} op		4.5 to 14.0	V

SANYO Electric Co.,Ltd. Semiconductor Business Headquarters

TOKYO OFFICE Tokyo Bldg., 1-10, 1 Chome, Ueno, Taito-ku, TOKYO, 110 JAPAN

D3097HA(II)/N257TA/7027TA,TS No.2620-1/12

LA3242

Operating Characteristics at Ta = 25°C, V_{CC} = 6.0 V, R_L = 10 kΩ, f = 1 kHz, 0 dB = 0.775 V

Parameter	Symbol	Conditions	min	typ	max	Unit
Quiescent current	I _{CCO}	Me/Nor, Nor/High SW OFF	5	7.5	12	mA
Quiescent current	I _{CCS}	Me/Nor, Nor/High SW ON	12	16	20	mA
[REC Amp]						
Voltage gain (Open)	VG _{O1}		75	85		dB
Voltage gain (Closed)	VG1	V _O = 0 dBm	42.5	44.5	46.0	dB
Total harmonic distortion	THD 1	V _O = 0.4 V		0.1	0.7	%
Maximum output voltage	V _O max	THD = 1%	0.7	1.0		V
Equivalent input noise voltage	V _{NI1}	R _g = 2.2 kΩ, B.P.F = 20 Hz to 20 kHz		1.1	1.7	μV
Input resistance	R _{I1}		40	50	60	kΩ
Crosstalk	CT1	Between REC amps	50	60		dB
	CT2	REC amp→Microphone amp	50	75		dB
Channel balance	V _{BL}	V _{IN} = -50 dBm		0	2	dB
[Microphone Amp]						
Voltage gain (Open)	VG _{O2}		60	70		dB
Voltage gain (Closed)	VG2	V _O = 0 dBm	23	25	27	dB
Total harmonic distortion	THD2	V _O = 0.4 V		0.05	0.5	%
Maximum output voltage	V _O max	THD = 1%	0.8	1.1		V
Equivalent input noise voltage	V _{NI2}	R _g = 2.2 kΩ, B.P.F = 20 Hz to 20 kHz		1.1	1.7	μV
Input resistance	R _{I2}		40	50	60	kΩ
Crosstalk	CT3	Microphone amp→REC amp	45	60		dB
[ALC]						
ALC range	ALC _W	Input range when output distortion becomes 1% after ALC begins to be applied.	40	45		dB
ALC balance	ALC _B	Output difference between CH1 and CH2		0	2	dB
ALC distortion	ALC _{THD}	V _{IN} = -40 dBm		0.15	0.8	%
ALC output voltage	ALC _{VO}	V _{IN} = -40 dBm	0.33	0.42	0.53	V
Crosstalk	CT4	Between REC amps	45	60		dB
Crosstalk	CT5	REC amp→Microphone amp	50	70		dB
ALC ON-state voltage	ALC _{ON}	Voltage on pin 17			1.0	V
ALC OFF-state voltage	ALC _{OFF}	Voltage on pin 17	1.5			V
[Switch]						
ON-state resistance	R _{ON}			30	70	Ω
DC feedback resistance	R _{F1}		40	50	60	kΩ

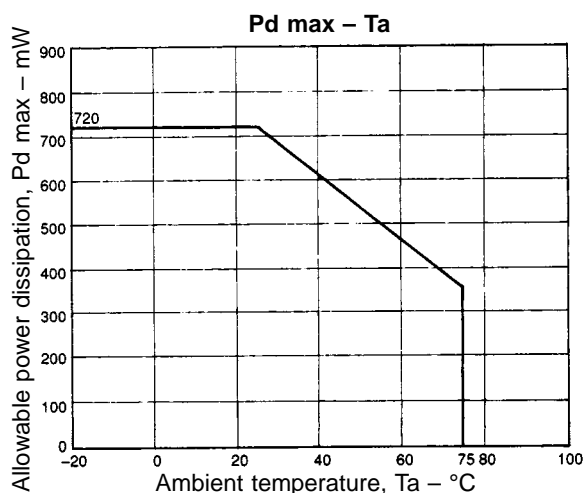

LA3242

Equivalent Circuit Block Diagram

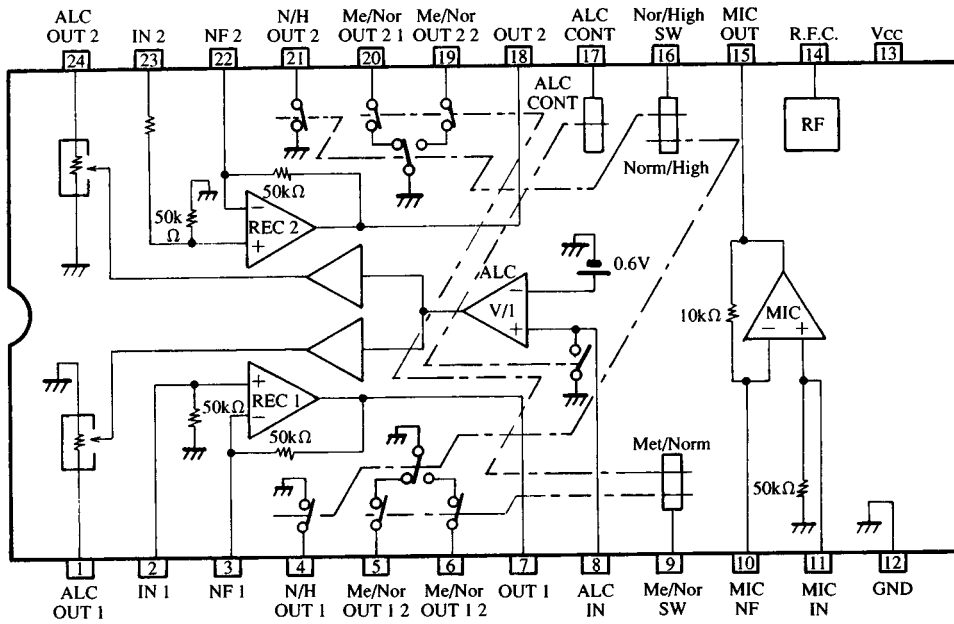

Top view

Equivalent Circuit

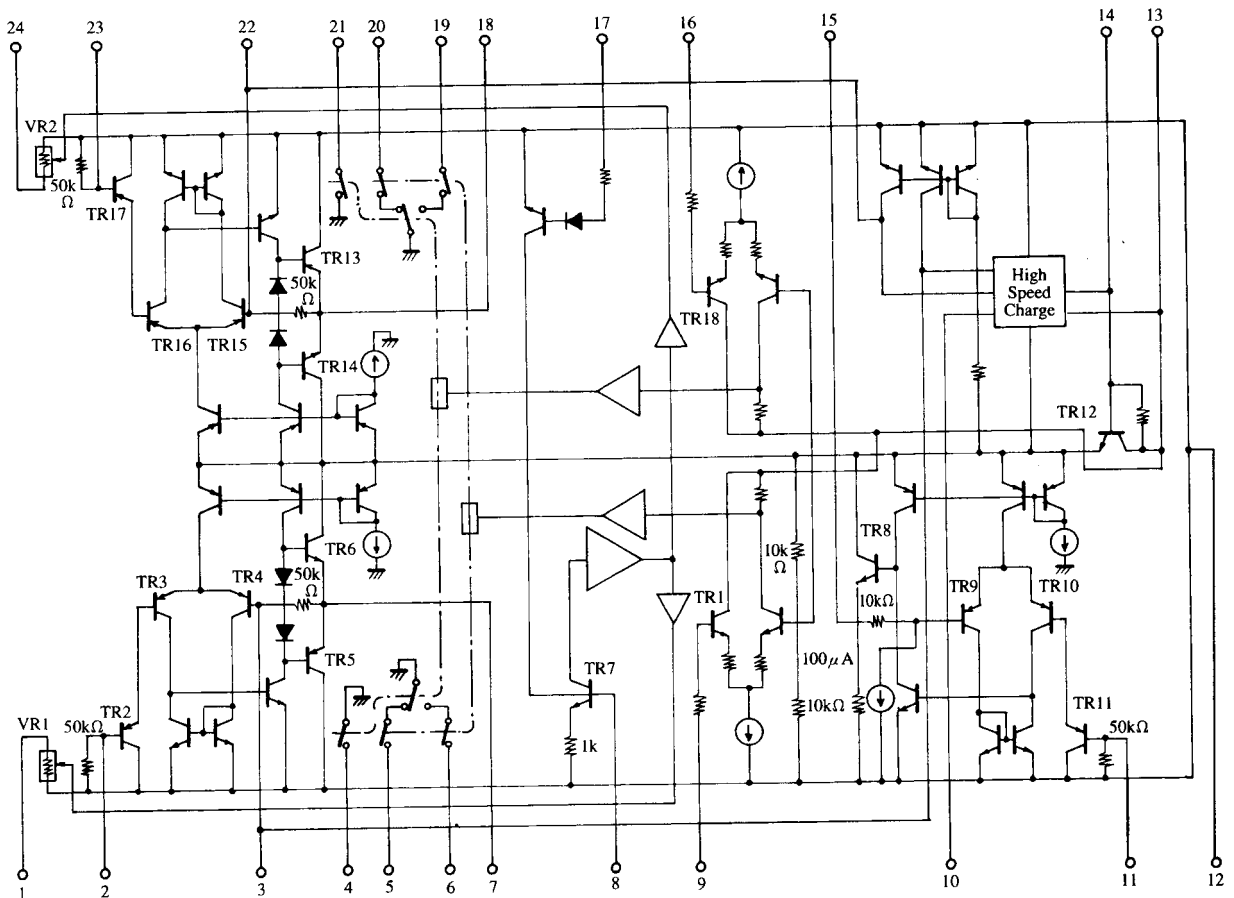

Sample Application Circuit

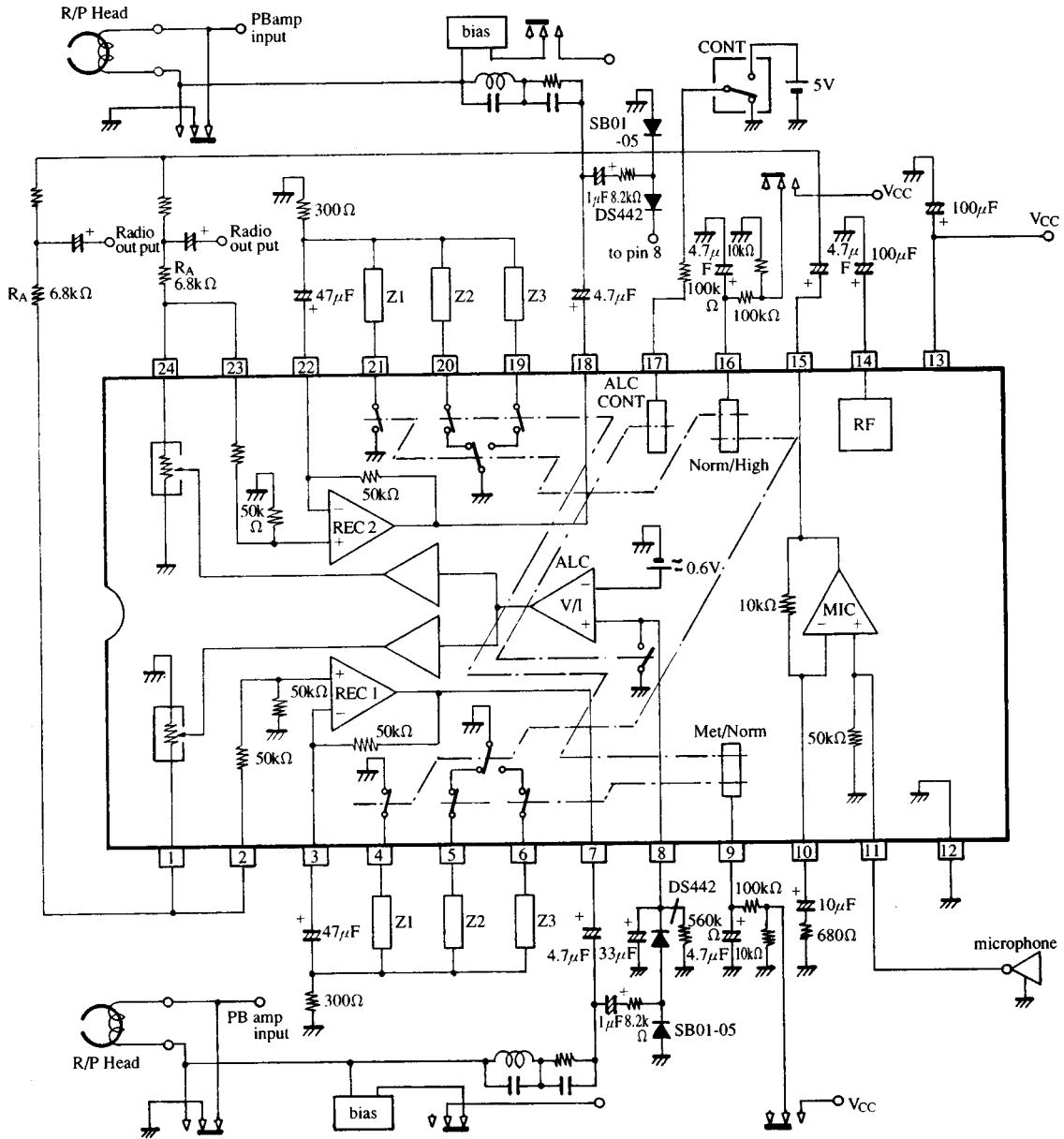

Note:

1. The electronic select switching level is approximately $(V_{CC} - 0.9)/2$.
2. REC amplifier NF parameters Z1 through Z3 should be selected to accommodate the recording level and frequency response that will be required in metal/normal tape and normal/higher speed modes.
3. Z1 through Z3 may be configured with coil "L", capacitor "C", and resistor "R".
4. When electronic control pins 9 and 16 are at the GND level, each electronic switch is turned ON.
5. When ALC ON/OFF control pin 17 is at 1 V or less/1.5 V or greater, the ALC is turned ON/OFF, respectively ($T_a = 25^\circ\text{C}$).
6. The ALC width depends on external resistor R_A .

LA3242

Test Circuit

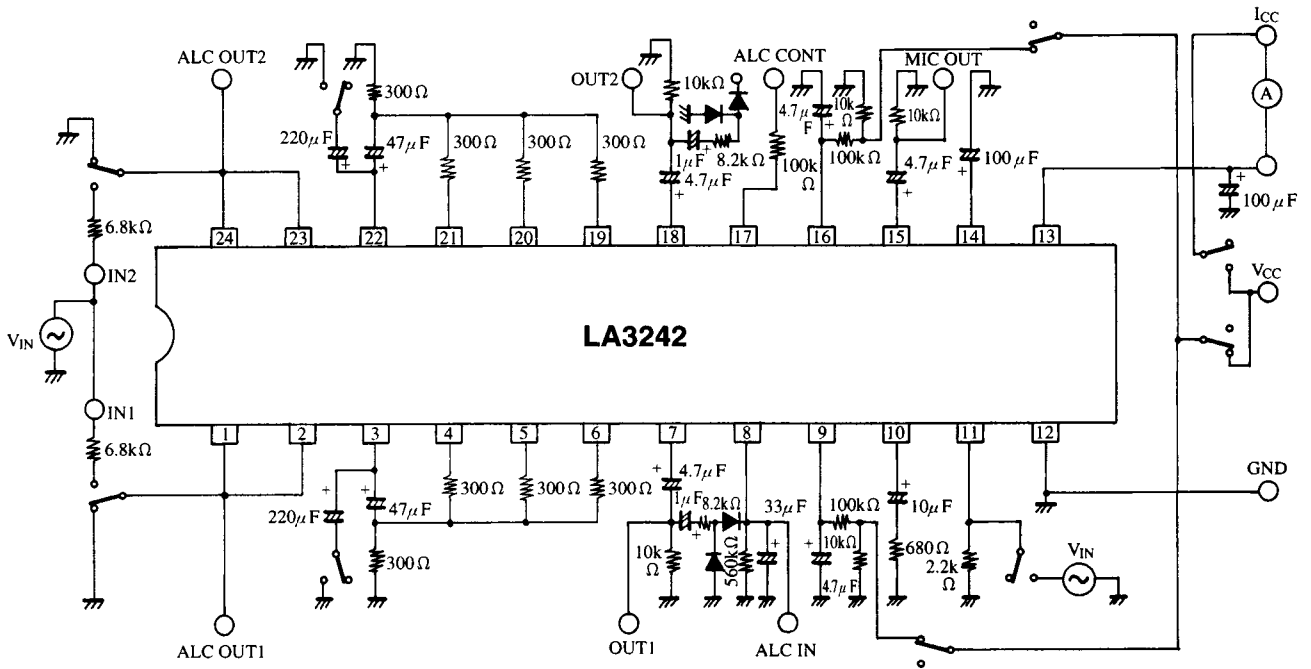

Sample Printed Circuit Pattern (Cu-foiled area)

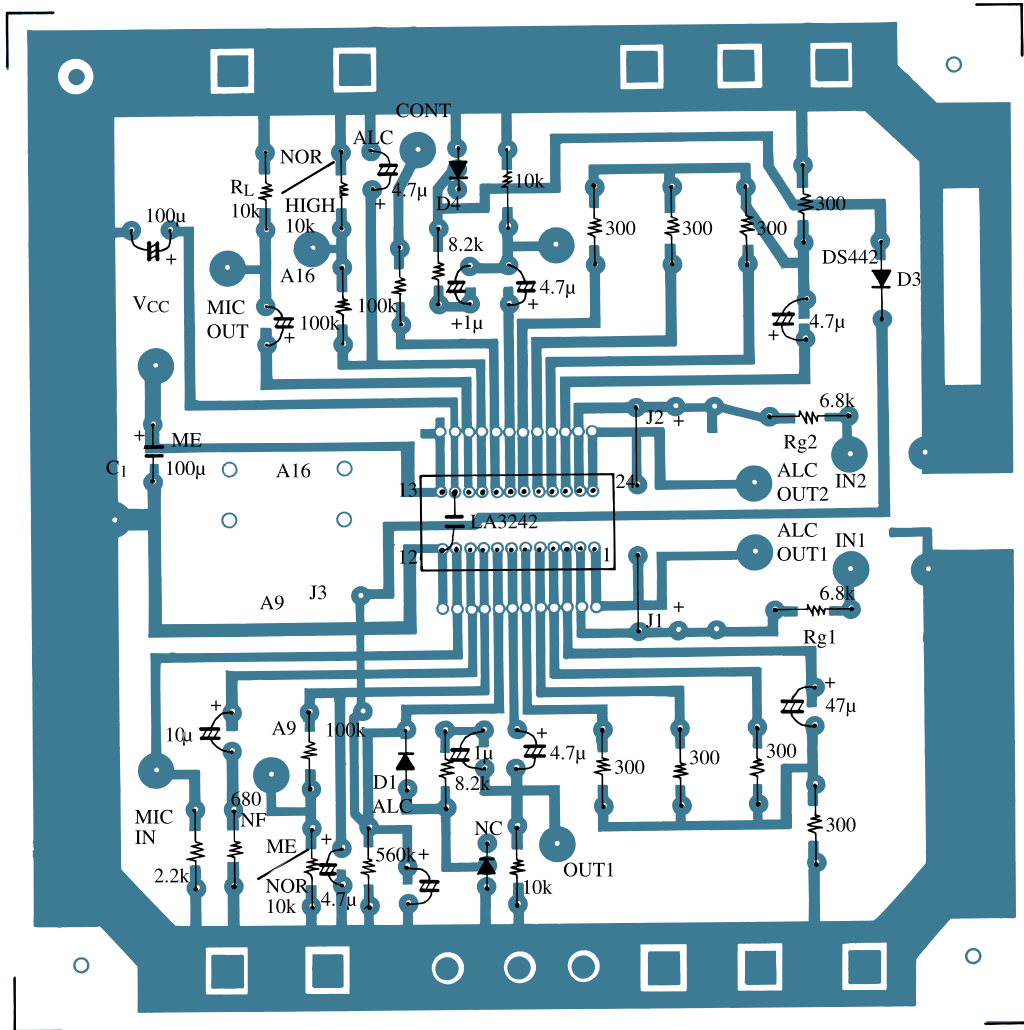

130 × 130 mm²
Unit (resistance: Ω, capacitance: F)

IC usage Notes

- (1) The base of a PNP transistor is connected to input pins 2 and 23.

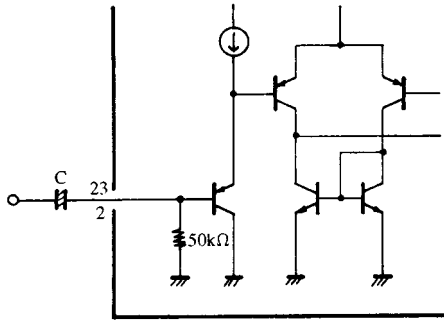

When a voltage is applied to input pins 2 and 23 externally, connect a capacitor to the input pins. The recommended value of capacitor C is 0.1 μF to 10 μF. DC voltage V_{INDC} with input pins 2 and 23 open is 50 mV max ($V_{INDC} = 20$ mV typ).

For the relation between supply voltage V_{CC} and V_{INDC} , refer to the $V_{CC} - V_{INDC}$ characteristic.

- (2) Output waveform starting time (Refer to Data $t_s - C_T$.)

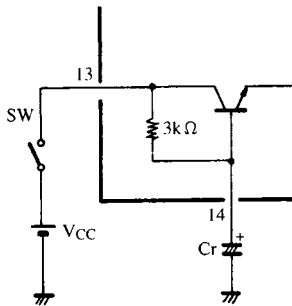

Rise waveform at pin 7 or 18

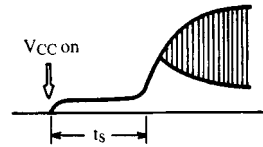

When supply voltage V_{CC} is switched ON, the amplifier output (pins 7 and 18) will rise. Output waveform ON time t_s can be varied by capacitor C_r connected to pin 12. The minimum value of C_r is 33 μF. If the value of C_r is made less than 33 μF, more pop noise will occur and the ripple rejection will worsen at the time supply voltage V_{CC} is switched ON. ($t_s = 0.7$ s. typ at $C_r = 100$ μF)

- (3) Electronic switch control circuit

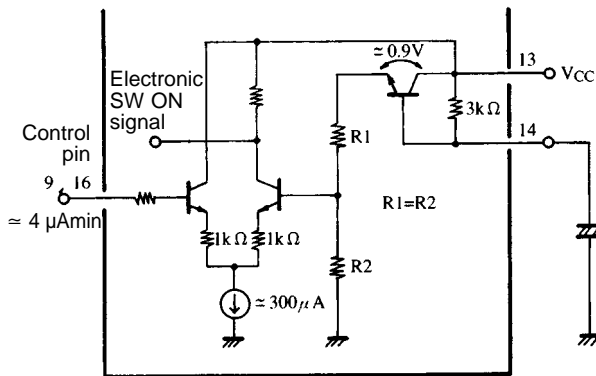

The control circuit for control pins 9 and 16 is configured as shown left.

Control level V_{CONT} of the control circuit is given by:
 $V_{CONT} = 1/2 \times (V_{CC} - 0.9)$ [V]

- (4) Relation between control voltage to turn ON/OFF electronic switch and supply voltage (Refer to Data $V_{CONT} - V_{CC}$.)

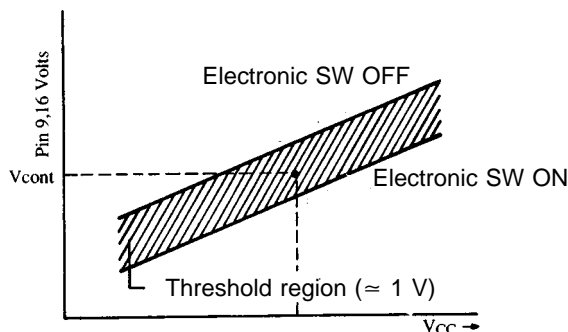

The control level at electronic switch CONT pin 9 and 16 is fixed by supply voltage V_{CC} . The threshold region has a range of approximately 1 V. The middle point of threshold region at a given value of supply voltage V_{CC} is represented by approximately $1/2 \times (V_{CC} - 0.9)$ V.

The electronic switch can be turned ON/OFF by applying a voltage of the middle point voltage ± 0.5 V or more/less, respectively, to electronic switch CONT pins 9 and 16.

(5) ALC control pin and ON/OFF level

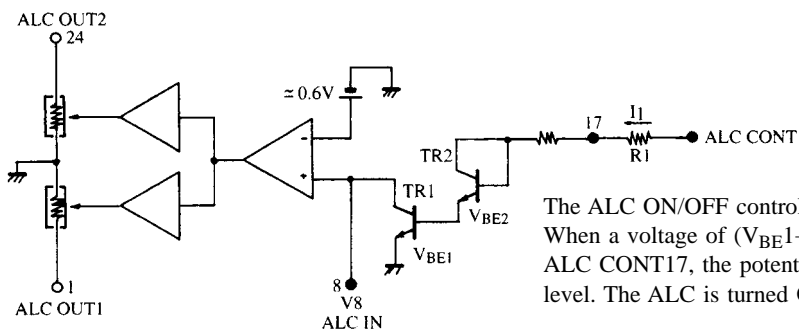

The ALC ON/OFF control circuit is configured as shown left. When a voltage of $(V_{BE1} + V_{BE2}) = 1.5\text{ V}$ or greater is applied to the ALC CONT17, the potential on the ALC IN (pin 8) drops to GND level. The ALC is turned OFF (ALC function release).

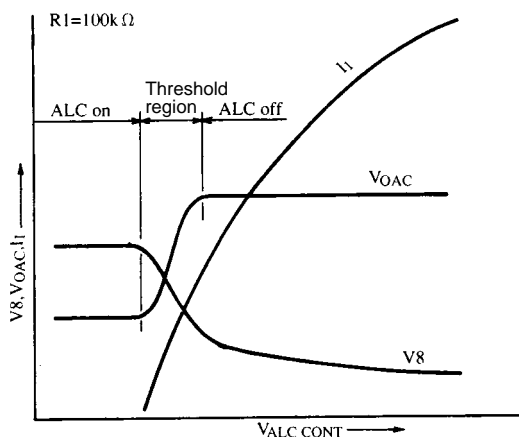

REC amplifier output V_{OAC} is controlled by the ALC CONT voltage and the threshold region has a range of approximately 0.5 V. The ALC CONT voltage is set to 1.0 V or less/1.5 V or greater to turn ON/OFF the ALC, respectively.

(Refer to Data V_{OAC} , V8, $I_1 - V_{ALC CONT}$.)

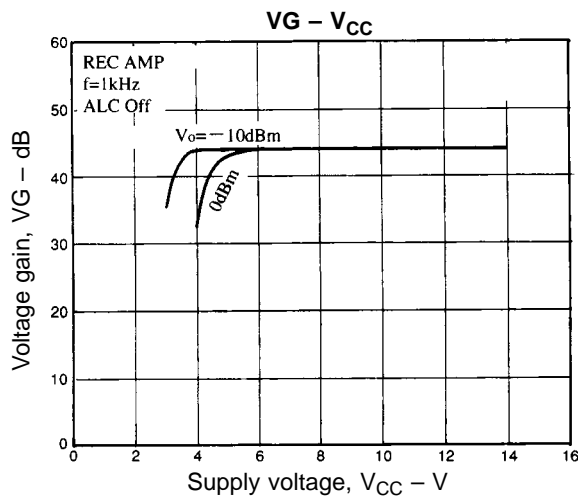
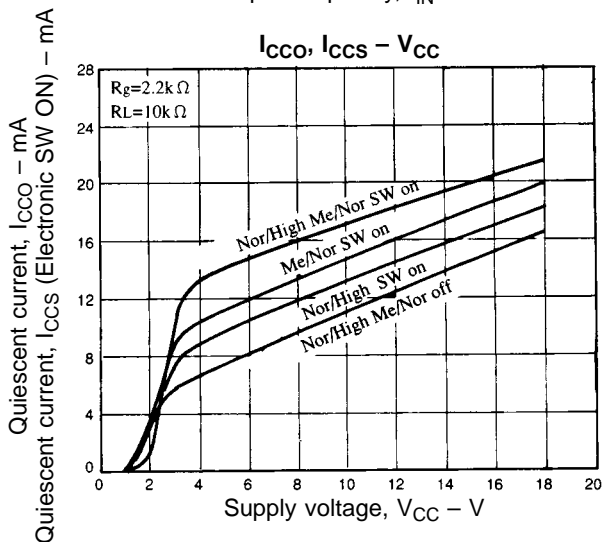
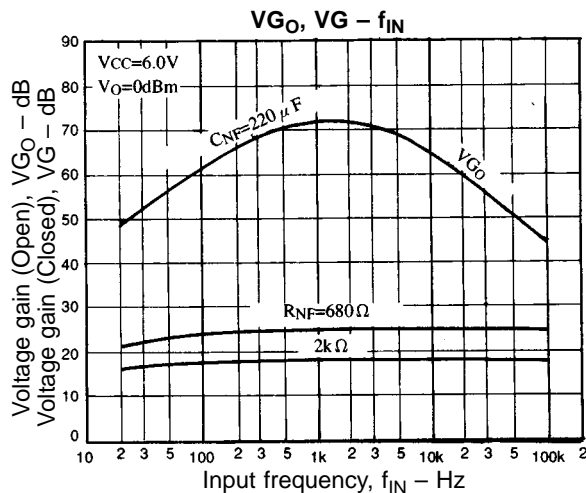
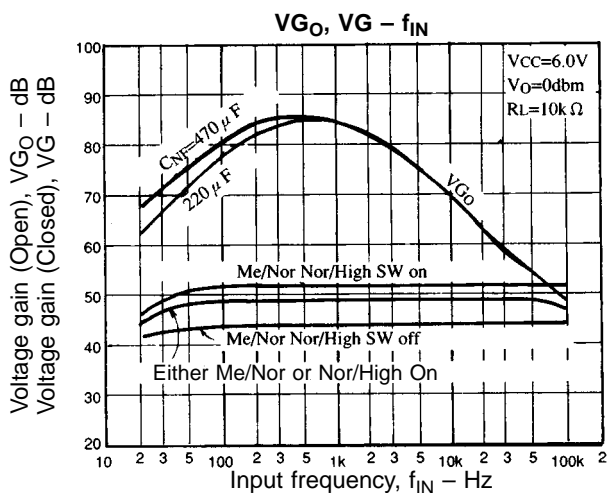

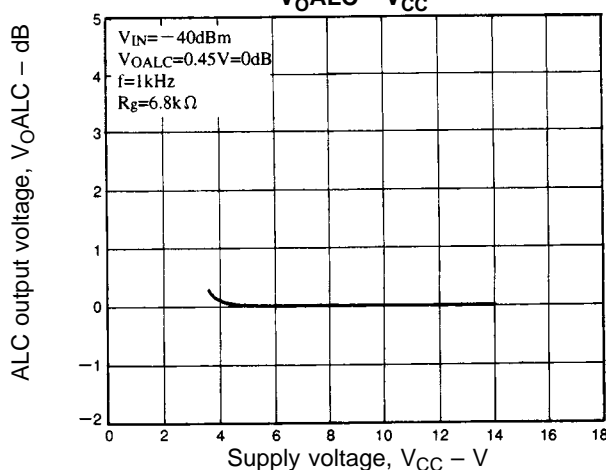
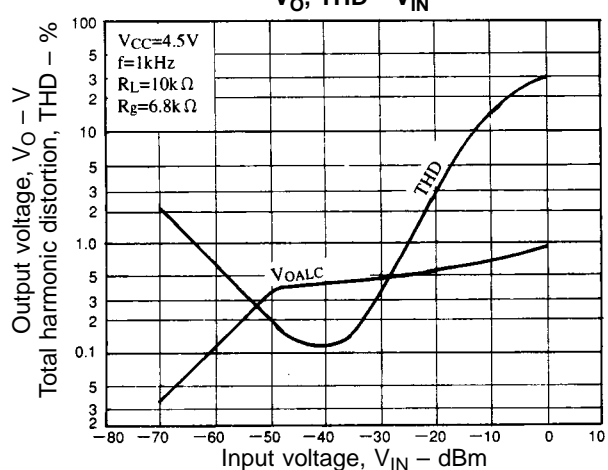
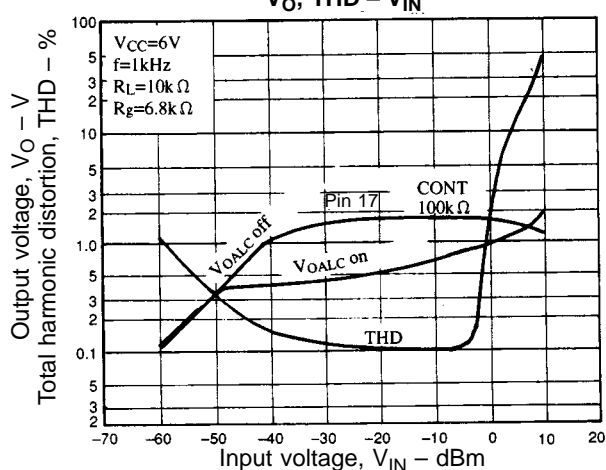
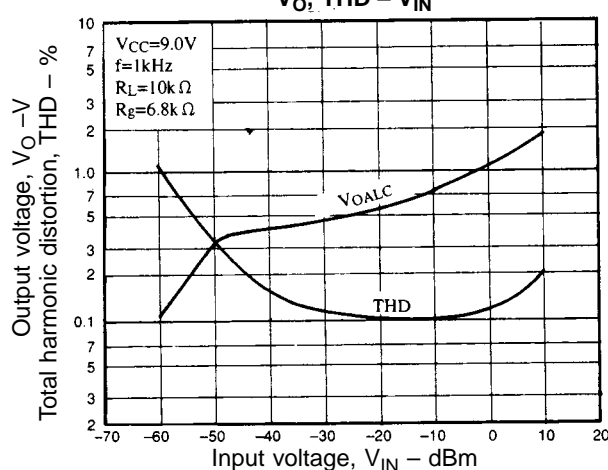
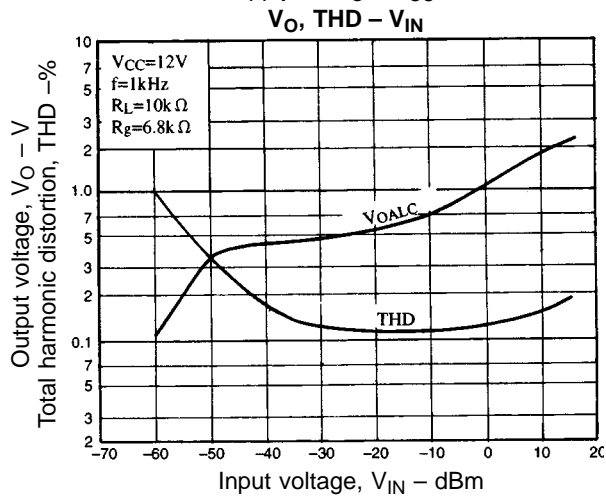
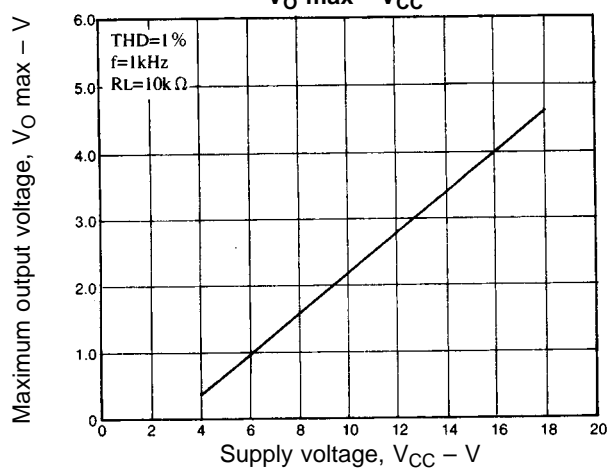
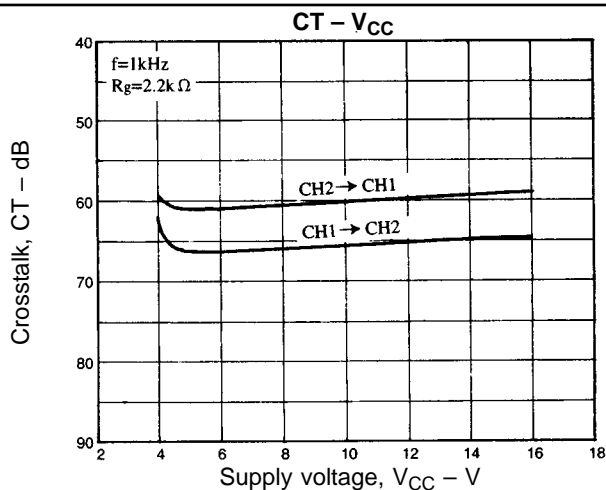
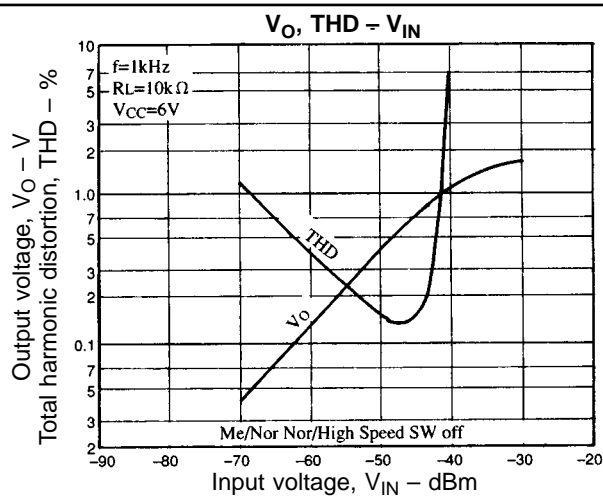

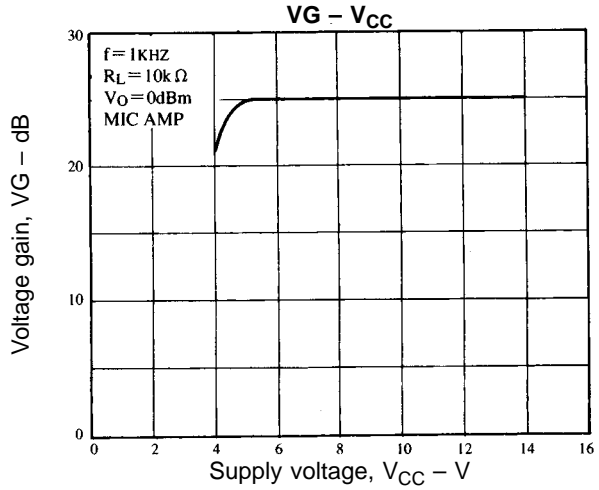
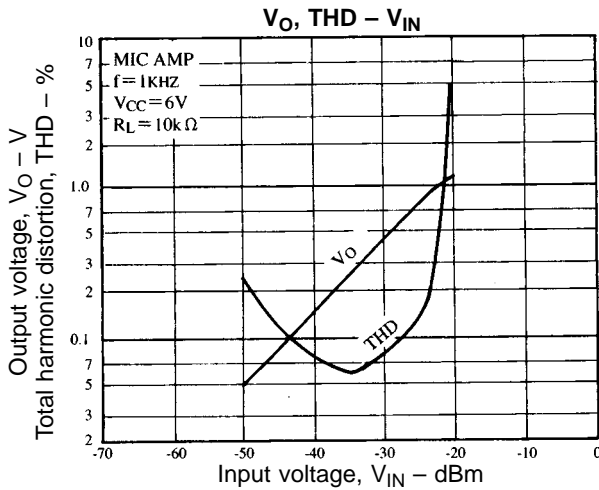
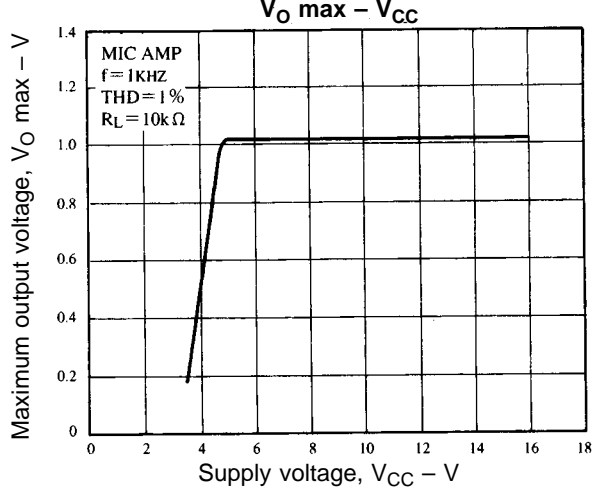
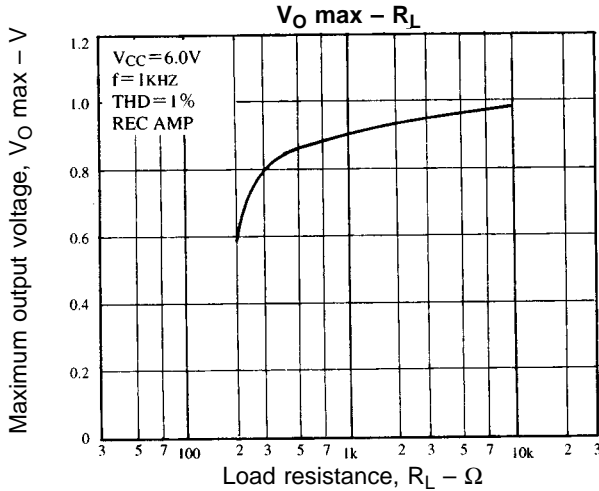
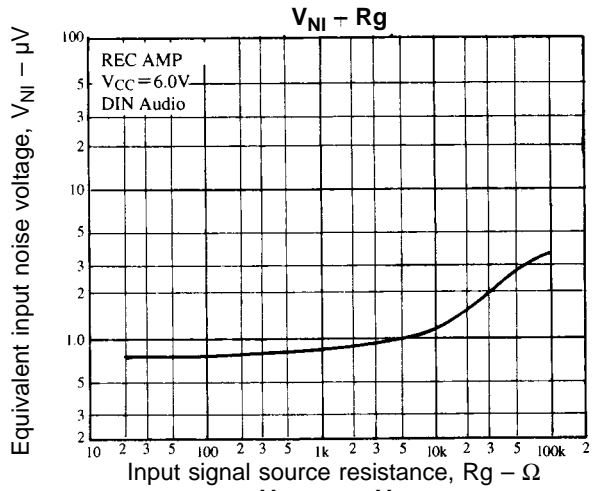
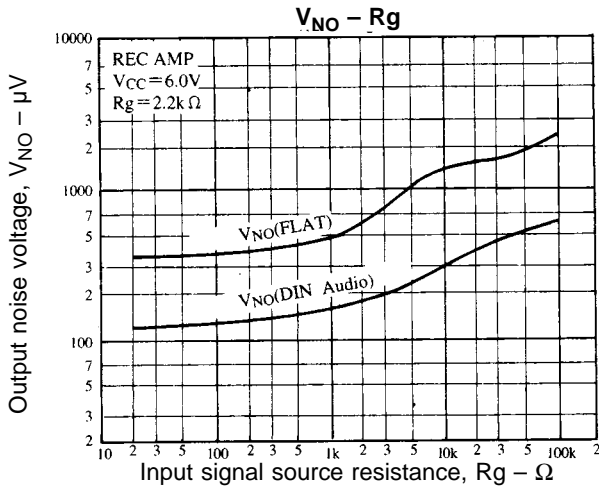
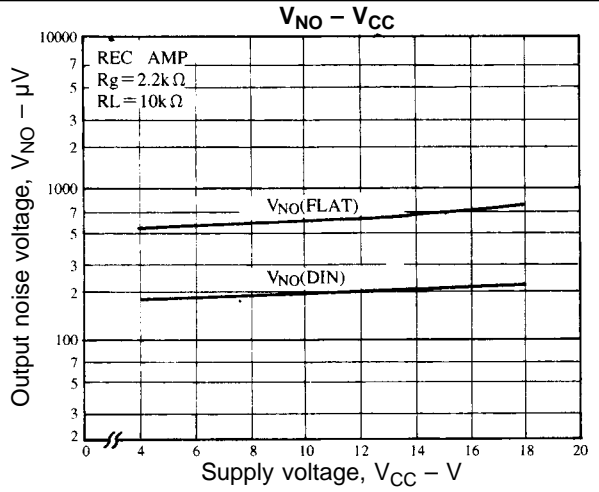
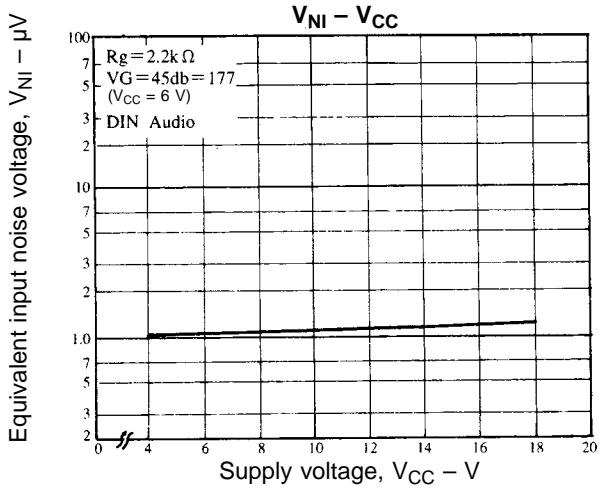

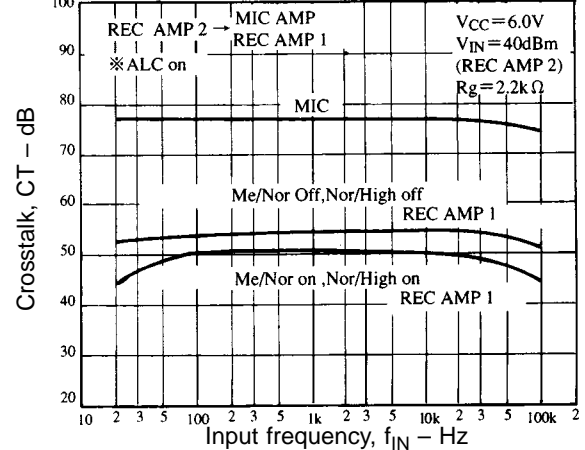
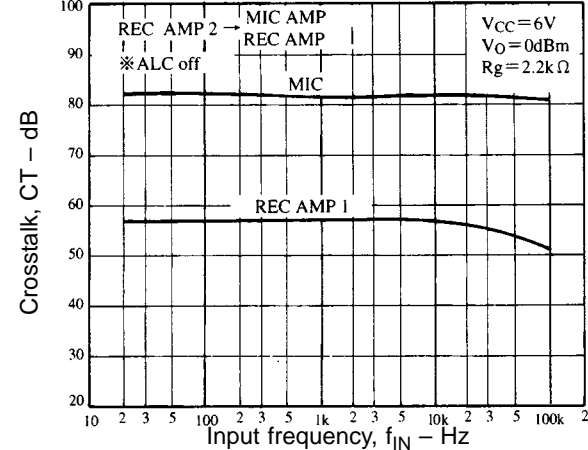
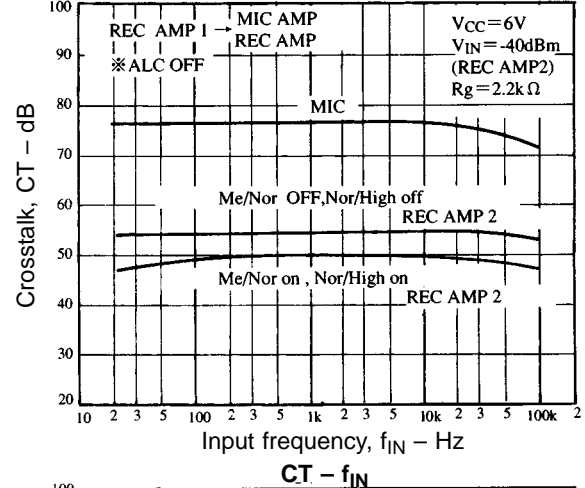
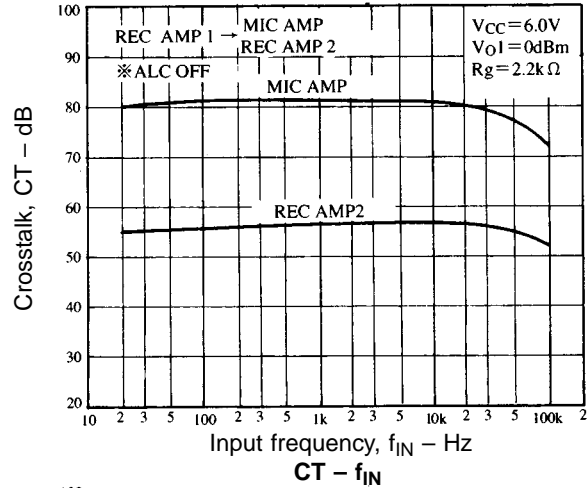
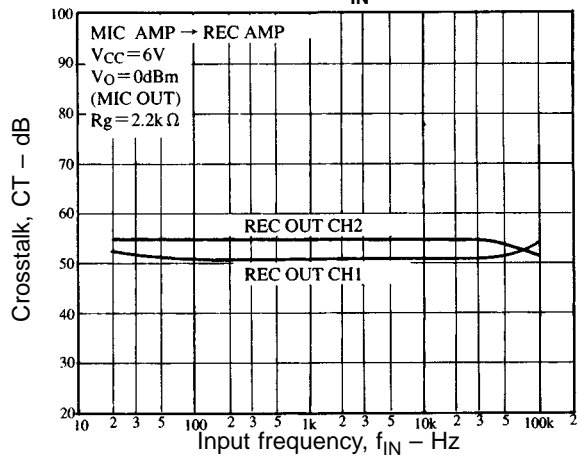
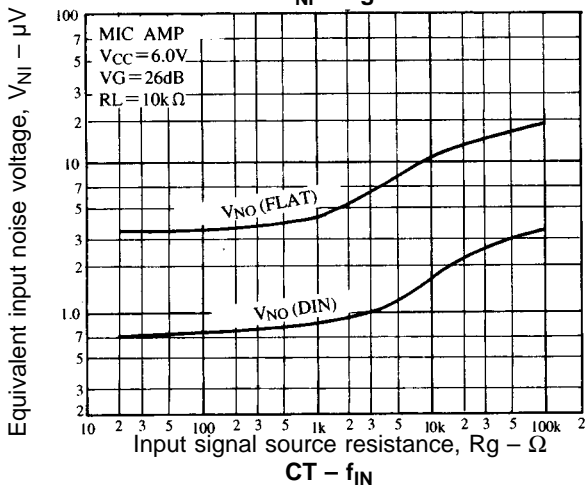
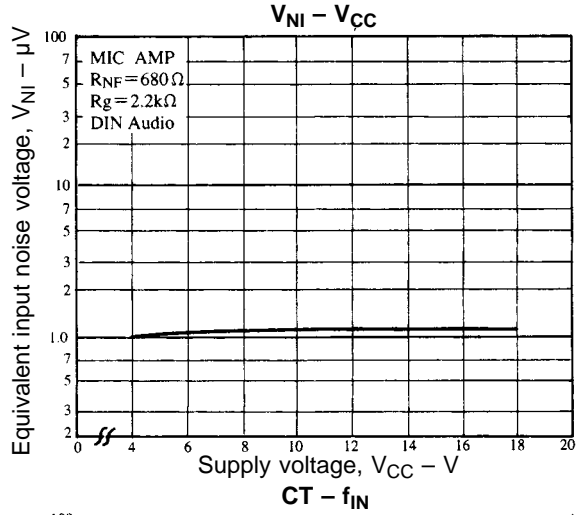
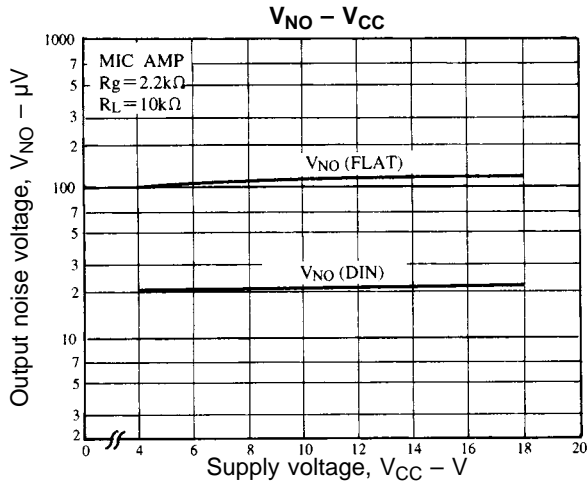

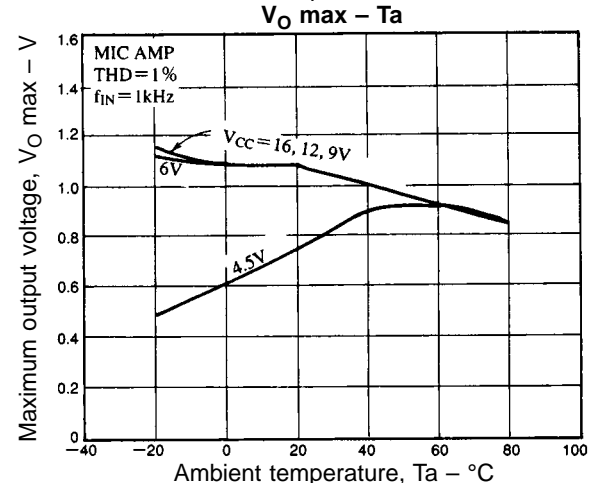
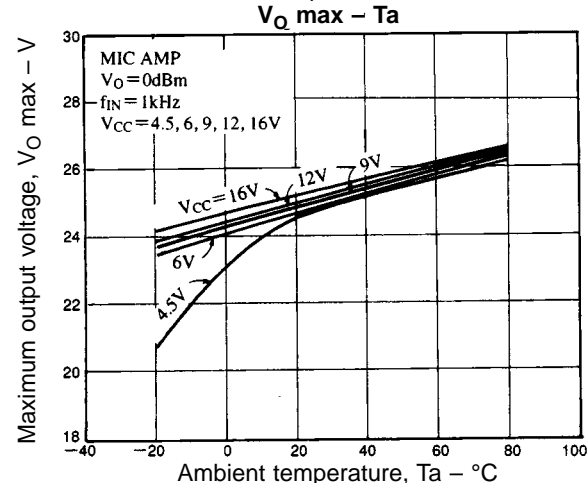
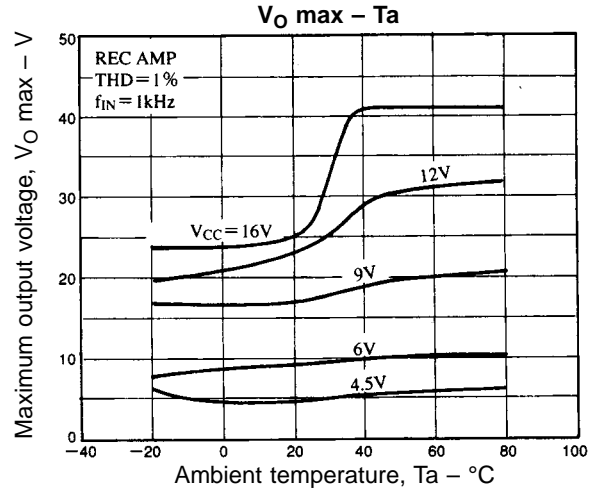
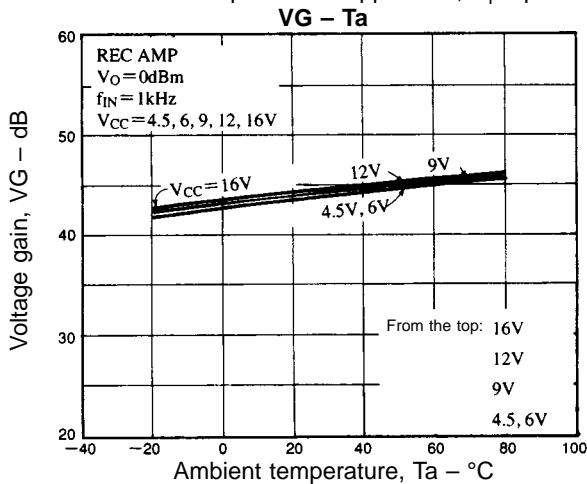
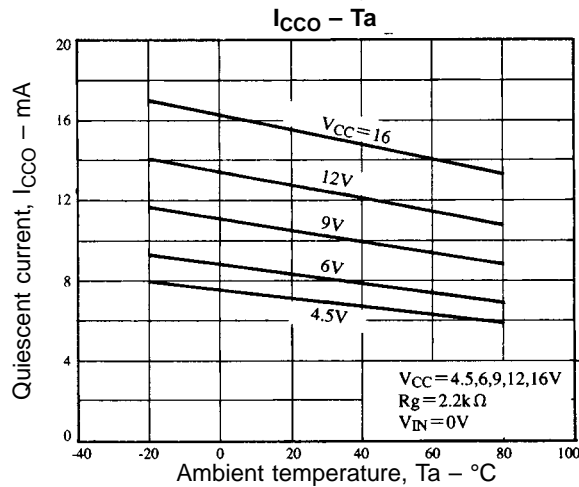
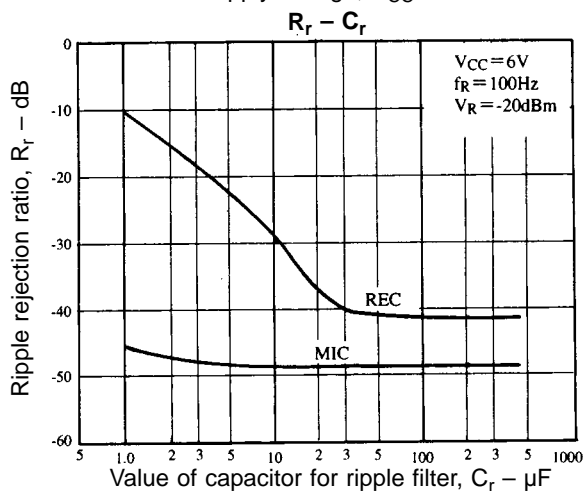
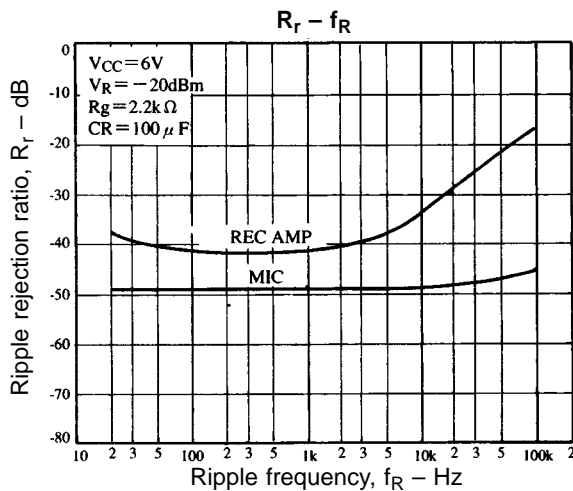
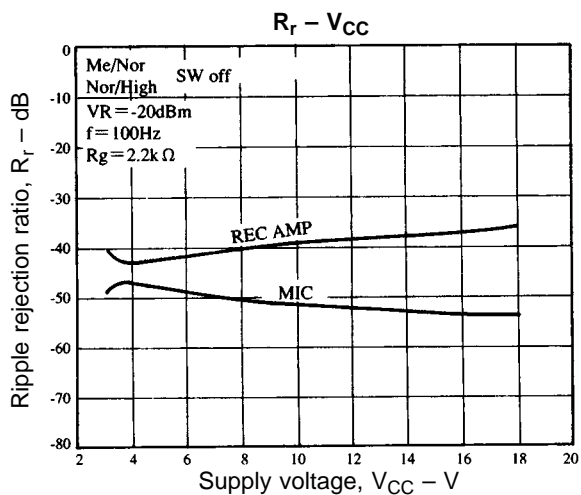

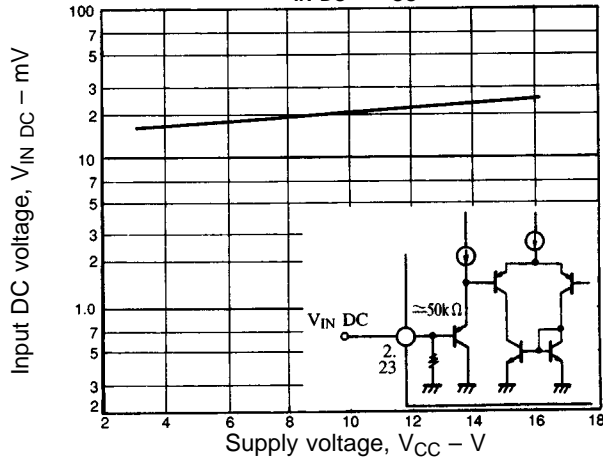
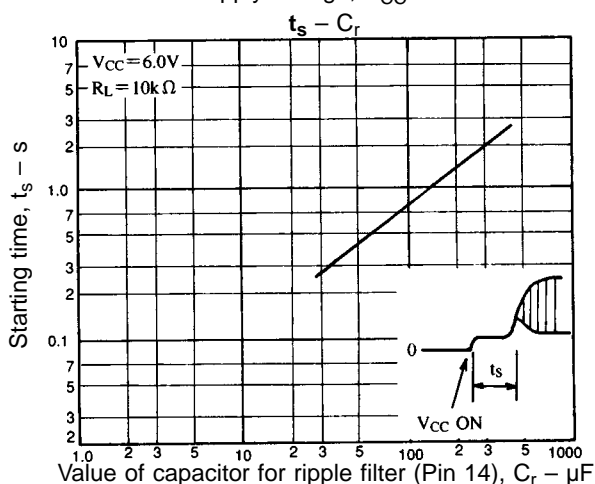
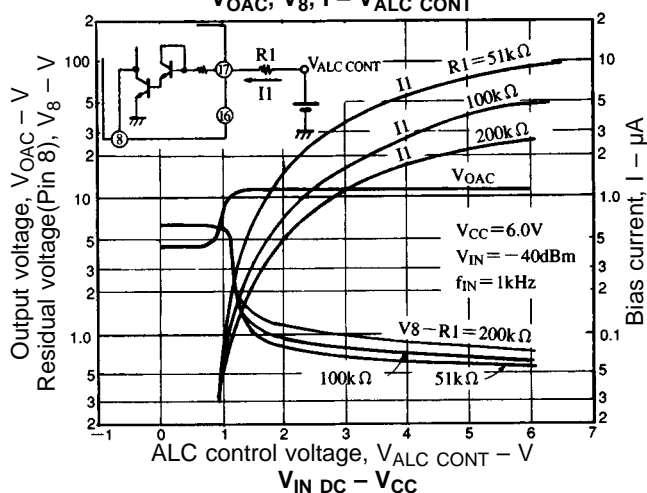
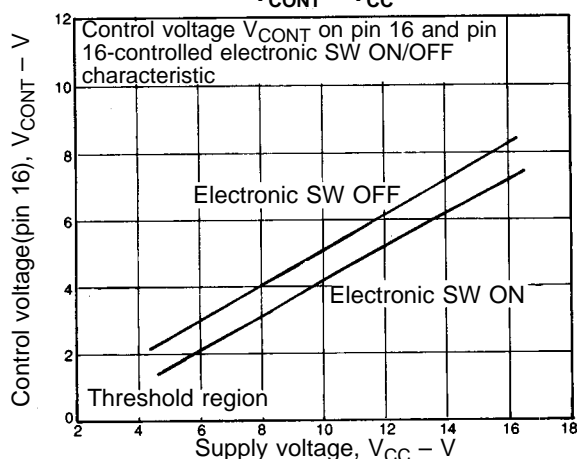
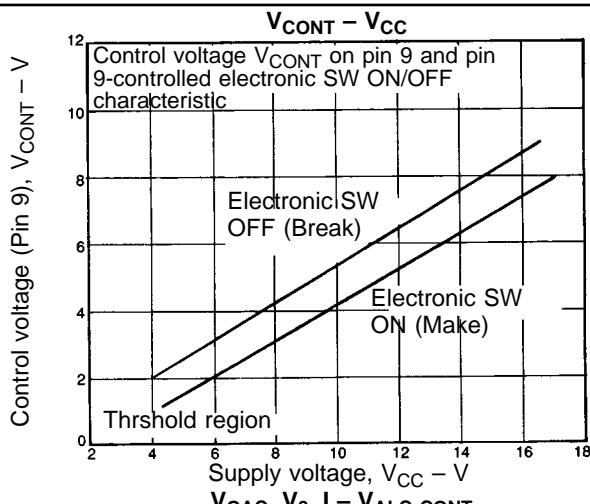
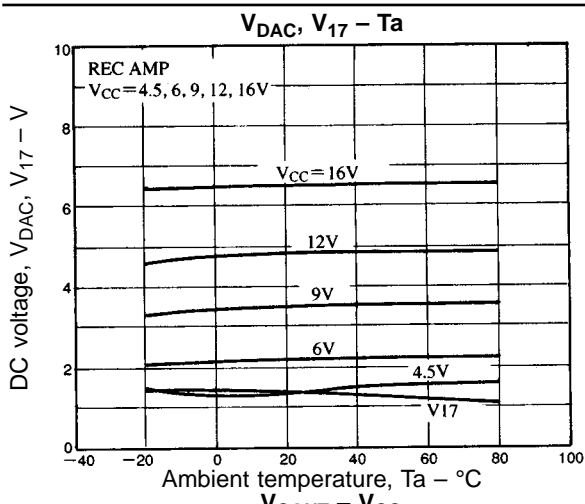

- No products described or contained herein are intended for use in surgical implants, life-support systems, aerospace equipment, nuclear power control systems, vehicles, disaster/crime-prevention equipment and the like, the failure of which may directly or indirectly cause injury, death or property loss.
- Anyone purchasing any products described or contained herein for an above-mentioned use shall:
 - ① Accept full responsibility and indemnify and defend SANYO ELECTRIC CO., LTD., its affiliates, subsidiaries and distributors and all their officers and employees, jointly and severally, against any and all claims and litigation and all damages, cost and expenses associated with such use:
 - ② Not impose any responsibility for any fault or negligence which may be cited in any such claim or litigation on SANYO ELECTRIC CO., LTD., its affiliates, subsidiaries and distributors or any of their officers and employees jointly or severally.
- Information (including circuit diagrams and circuit parameters) herein is for example only; it is not guaranteed for volume production. SANYO believes information herein is accurate and reliable, but no guarantees are made or implied regarding its use or any infringements of intellectual property rights or other rights of third parties.