



LC7986C

LCD Controller/Driver

Overview

The LC7986C is a low-power CMOS IC that incorporates dot-matrix character generator, display controller and driver functions in a single device, and realizes ideal for use in portable equipment containing LCD displays.

Also, the CMOS process realizes easy expansion to control displays of up to 80 characters by adding LC7930N or LC7931D display drivers.

Features

- Controller and driver for dot-matrix LCD displays
- 5 × 7-pixel and 5 × 10-pixel character fonts
- 160, 5 × 7-pixel characters and 32, 5 × 10-pixel characters in character generator ROM
- Eight, 5 × 7-pixel characters or four, 5 × 10-pixel characters in character generator RAM
- 80-character display data RAM
- Built-in drivers for 1-line × 16-character and 2-line × 16-character displays
- Easy expansion to 1-line × 80-character or 2-line × 40-character displays by adding LC7930Ns or LC7931Ds
- 4-bit or 8-bit microcontroller interface
- 11 microcontroller instructions
- Built-in reset circuit
- Built-in oscillator
- 5V supply
- 128-pad dice

Pad Layout

Chip size: 5.69 × 3.45mm²

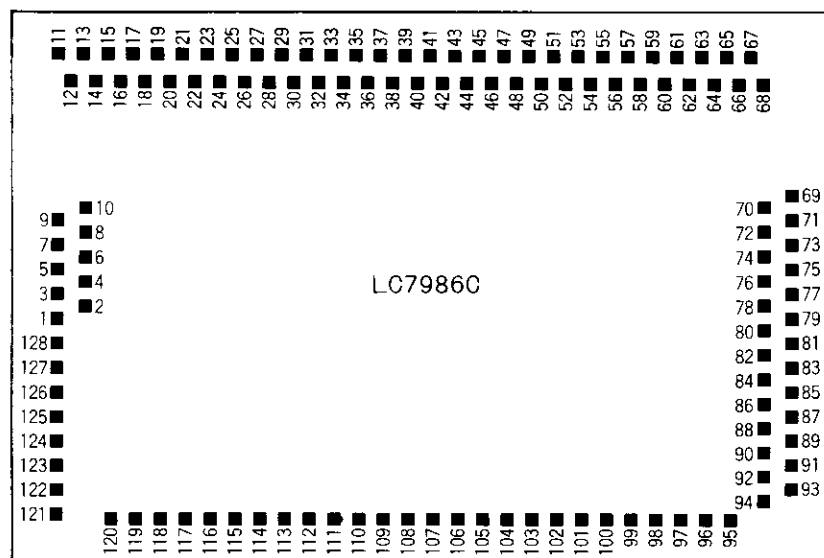

Pad Coordinates

The coordinate origin is in the center of the chip.

Pad		Coordinates		Pad		Coordinates		Pad		Coordinates	
Number	Name	X	Y	Number	Name	X	Y	Number	Name	X	Y
1	OS1	2660.0	76.9	48	OS48	-748.6	-1380.0	95	OC2	-2217.5	1540.0
2	OS2	2500.0	-13.1	49	OS49	-838.6	-1540.0	96	OC1	-2037.5	1540.0
3	OS3	2660.0	-103.1	50	OS50	-928.6	-1380.0	97	V1'	-1701.1	1540.0
4	OS4	2500.0	-193.1	51	OS51	-1018.6	-1540.0	98	V1	-1541.1	1540.0
5	OS5	2660.0	-283.1	52	OS52	-1108.6	-1380.0	99	V2'	-1381.1	1540.0
6	OS6	2500.0	-373.1	53	OS53	-1198.6	-1540.0	100	V2	-1221.1	1540.0
7	OS7	2660.0	-463.1	54	OS54	-1288.6	-1380.0	101	V3'	-1061.1	1540.0
8	OS8	2500.0	-553.1	55	OS55	-1378.6	-1540.0	102	V3	-901.1	1540.0
9	OS9	2660.0	-643.1	56	OS56	-1468.6	-1380.0	103	V4'	-741.1	1540.0
10	OS10	2500.0	-733.1	57	OS57	-1558.6	-1540.0	104	V4	-581.1	1540.0
11	OS11	2581.4	-1540.0	58	OS58	-1648.6	-1380.0	105	V5'	-421.1	1540.0
12	OS12	2491.4	-1380.0	59	OS59	-1738.6	-1540.0	106	V5	-261.1	1540.0
13	OS13	2401.4	-1540.0	60	OS60	-1828.6	-1380.0	107	V _{SS}	-101.1	1540.0
14	OS14	2311.4	-1380.0	61	OS61	-1918.6	-1540.0	108	V _{DD}	58.9	1540.0
15	OS15	2221.4	-1540.0	62	OS62	-2008.6	-1380.0	109	OSCO	218.9	1540.0
16	OS16	2131.4	-1380.0	63	OS63	-2098.6	-1540.0	110	OSCR	378.9	1540.0
17	OS17	2041.4	-1540.0	64	OS64	-2188.6	-1380.0	111	OSCI	538.9	1540.0
18	OS18	1951.4	-1380.0	65	OS65	-2278.6	-1540.0	112	CP	698.9	1540.0
19	OS19	1861.4	-1540.0	66	OS66	-2368.6	-1380.0	113	LOAD	858.9	1540.0
20	OS20	1771.4	-1380.0	67	OS67	-2458.6	-1540.0	114	M	1018.9	1540.0
21	OS21	1681.4	-1540.0	68	OS68	-2548.6	-1380.0	115	D	1178.9	1540.0
22	OS22	1591.4	-1380.0	69	OS69	-2660.0	-733.1	116	SHL	1338.9	1540.0
23	OS23	1501.4	-1540.0	70	OS70	-2500.0	-643.1	117	A/B	1498.9	1540.0
24	OS24	1411.4	-1380.0	71	OS71	-2660.0	-553.1	118	E	1658.9	1540.0
25	OS25	1321.4	-1540.0	72	OS72	-2500.0	-463.1	119	R/W	1818.9	1540.0
26	OS26	1231.4	-1380.0	73	OS73	-2660.0	-373.1	120	RS	1978.9	1540.0
27	OS27	1141.4	-1540.0	74	OS74	-2500.0	-283.1	121	DB7	2660.0	1540.0
28	OS28	1051.4	-1380.0	75	OS75	-2660.0	-193.1	122	DB6	2660.0	1360.0
29	OS29	961.4	-1540.0	76	OS76	-2500.0	-103.1	123	DB5	2660.0	1180.0
30	OS30	871.4	-1380.0	77	OS77	-2660.0	-13.1	124	DB4	2660.0	1000.0
31	OS31	781.4	-1540.0	78	OS78	-2500.0	76.9	125	DB3	2660.0	820.0
32	OS32	691.4	-1380.0	79	OS79	-2660.0	166.9	126	DB2	2660.0	640.0
33	OS33	601.4	-1540.0	80	OS80	-2500.0	256.9	127	DB1	2660.0	460.0
34	OS34	511.4	-1380.0	81	OC16	-2660.0	370.0	128	DB0	2660.0	280.0
35	OS35	421.4	-1540.0	82	OC15	-2500.0	460.0				
36	OS36	331.4	-1380.0	83	OC14	-2660.0	550.0				
37	OS37	241.4	-1540.0	84	OC13	-2500.0	640.0				
38	OS38	151.4	-1380.0	85	OC12	-2660.0	730.0				
39	OS39	61.4	-1540.0	86	OC11	-2500.0	820.0				
40	OS40	-28.6	-1380.0	87	OC10	-2660.0	910.0				
41	OS41	-118.6	-1540.0	88	OC9	-2500.0	1000.0				
42	OS42	-208.6	-1380.0	89	OC8	-2660.0	1090.0				
43	OS43	-298.6	-1540.0	90	OC7	-2500.0	1180.0				
44	OS44	-388.6	-1380.0	91	OC6	-2660.0	1270.0				
45	OS45	-478.6	-1540.0	92	OC5	-2500.0	1360.0				
46	OS46	-568.6	-1380.0	93	OC4	-2660.0	1450.0				
47	OS47	-658.6	-1540.0	94	OC3	-2500.0	1540.0				

Block Diagram

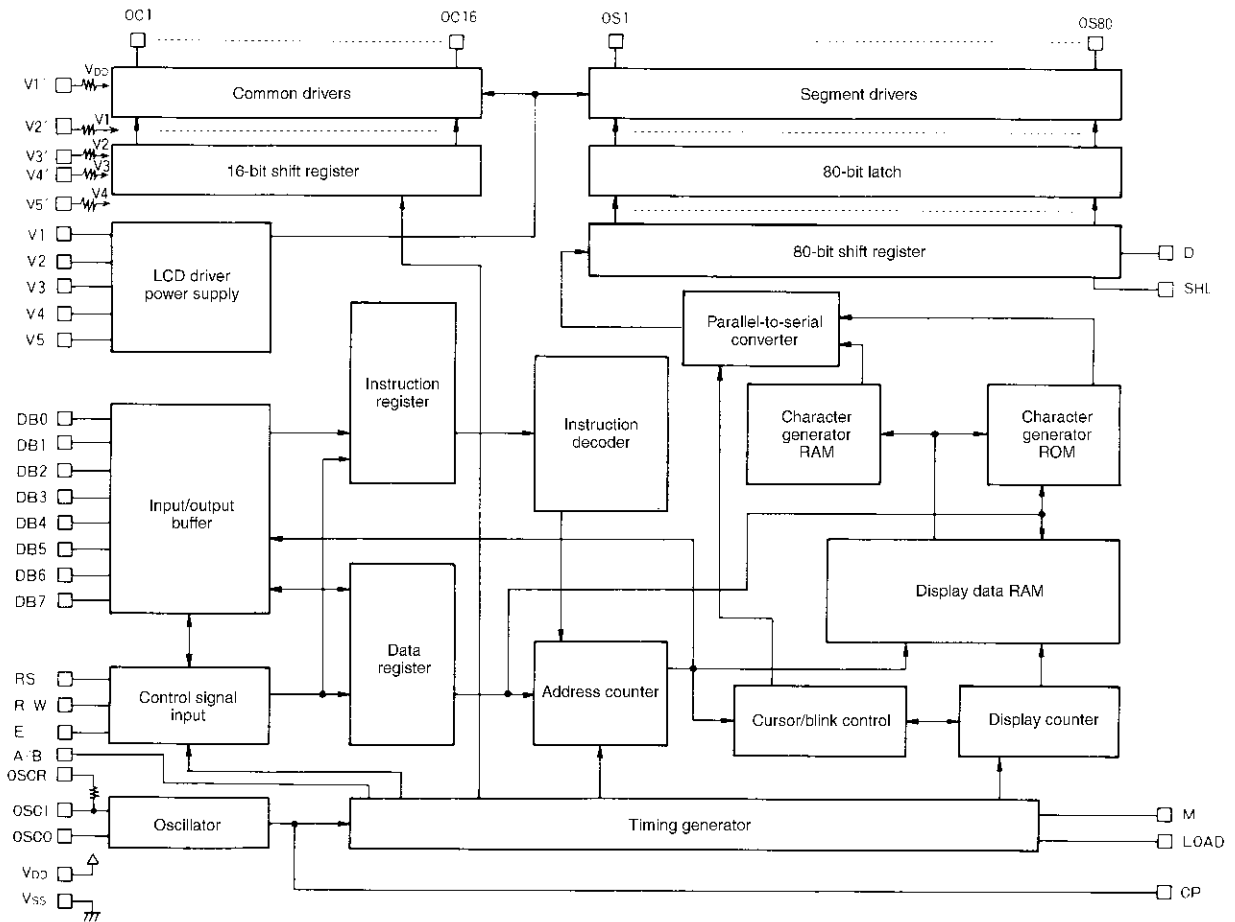

Specifications

The following characteristics apply to the ceramic-packaged device.

Absolute Maximum Ratings at $T_a = 25 \pm 2^\circ\text{C}$, $V_{SS} = 0\text{V}$

Parameter	Symbol	Ratings	Unit
Supply voltage range	$V_{DD\ max}$	-0.3 to +7.0	V
LCD drive supply voltage range* ¹	V_1 to V_5	$V_{DD} - 13.5$ to $V_{DD} + 0.3$	V
Input voltage range	V_i	-0.3 to $V_{DD} + 0.3$	V
Storage temperature range	Tstg	-55 to +125	°C

Note: *1. V_{DD} must obey the relationship: $V_{DD} \geq V_1 \geq V_2 \geq V_3 \geq V_4 \geq V_5$

Allowable Operating Ranges at $T_a = -20$ to $+75^\circ\text{C}$

Parameter	Symbol	Conditions	Ratings			Unit
			min	typ	max	
Supply voltage	V_{DD}		4.5	-	5.5	V
LCD driver reference voltages* ¹	V_{D5}	$V_{D5} = V_{DD} - V_5$	1.5	-	6.0	V
	V_{D1}	$V_{D1} = V_{DD} - V_1$	-	-	$0.25V_{D5}$	V
High-level input voltage	V_{IH1}	RS, R/W, E, DB0 to DB7	2.2	-	V_{DD}	V
	V_{IH2}	OSCI, SHL, A/B	$V_{DD} - 1.0$	-	V_{DD}	V
Low-level input voltage	V_{IL1}	RS, R/W, E, DB0 to DB7	-	-	0.6	V
	V_{IL2}	OSCI, SHL, A/B	-	-	1.0	V

Note: *1. These voltages guarantee correct operation of the LSI. They do not guarantee correct operation of the LCD panel. V_{LCD} must also be observed.

Electrical Characteristics at $T_a = -20$ to $+75^\circ\text{C}$, $V_{SS} = 0\text{V}$, $V_{DD} = 5\text{V} \pm 10\%$, unless otherwise noted

Parameter	Symbol	Conditions	Ratings			Unit
			min	typ	max	
High-level output voltage	V_{OH1}	$I_{OH} = -0.205\text{mA}$, input/output pins	2.4	-	-	V
	V_{OH2}	$I_{OH} = -0.04\text{mA}$, output pins	$0.9V_{DD}$	-	-	V
Low-level output voltage	V_{OL1}	$I_{OL} = 1.2\text{mA}$, input/output pins	-	-	0.4	V
	V_{OL2}	$I_{OL} = 0.04\text{mA}$, output pins	-	-	$0.1V_{DD}$	V
OC1 to OC16 driver voltage drop* ¹	V_{COM}	$I_d = 0.05\text{mA}$	-	-	2.9	V
OS1 to OS40 driver voltage drop* ²	V_{SEG}	$I_d = 0.05\text{mA}$	-	-	3.8	V
Input/output leakage current	I_L	$V_i = V_{SS}$ to V_{DD}	-	-	1	μA
Pull-up current	I_P	$V_{DD} = 5\text{V}$, RS, R/W, DB0 to DB7	50	125	250	μA
Supply current	I_{DD}	External feedback Rf oscillator, $V_{DD} = 5\text{V}$, $f_{OSC} =$ 320kHz, no output load	-	0.5	1.0	mA
		Internal feedback Rf oscillator	-	0.5	1.0	
External clock operating frequency	f_{CP}		125	-	410	kHz
External clock duty cycle	DUTY		45	50	55	%
External clock rise time	t_r		-	-	0.2	μs
External clock fall time	t_f		-	-	0.2	μs

LC7986C

Parameter	Symbol	Conditions	Ratings			Unit
			min	typ	max	
Internal oscillator operating frequency	f_{OSC}	Using $R_f = 56k\Omega \pm 3\%$	220	320	420	kHz
		Using built-in Vf	–	320	–	
RC oscillator built-in resistance	Vf	OSCO to OSCR	–	56	–	k Ω
LCD display voltage	V_{LCD1}	$V_{DD} - V_5$ (1/5 bias)	4.6	–	6	V
	V_{LCD2}	$V_{DD} - V_5$ (1/4 bias)	3.0	–	6	V
Voltage divider step resistance	V_R	Between V(n) and V(n+1)	–	2.2	–	k Ω

Note: *1. V_{COM} is the voltage from V_{DD} , V_1 , V_4 and V_5 to the LCD common drive pins OC1 to OC16.

Note: *2. V_{SEG} is the voltage from V_{DD} , V_2 , V_3 and V_5 to the LCD segment drive pins OS1 to OS80.

Switching Characteristics at $T_a = -20$ to $+75^\circ\text{C}$, $V_{SS} = 0\text{V}$, $V_{DD} = 5\text{V} \pm 10\%$

Parameter	Symbol	Conditions	Ratings			Unit
			min	typ	max	
E cycle time	$t_{E CYC}$		1000	–	–	ns
E high-level pulsewidth	t_{EW}		450	–	–	ns
E rise time	t_{ER}		–	–	25	ns
E fall time	t_{EF}		–	–	25	ns
RS and R/W to E setup time	t_{SU}		140	–	–	ns
E to RS and R/W address hold time	t_{AH}		10	–	–	ns
DB0 to DB7 to E data setup time	t_{DSU}		195	–	–	ns
Write cycle E to DB0 to DB7 data hold time	t_{DHW}		10	–	–	ns
Read cycle E to data valid delay time	t_{DD}	See measurement circuit.	–	–	320	ns
Read cycle E to DB0 to DB7 data hold time	t_{DHR}		20	–	–	ns
CP low-level pulsewidth	t_{WL}		800	–	–	ns
CP high-level pulsewidth	t_{WH}		800	–	–	ns
CP to LOAD setup time	t_{CSU}		500	–	–	ns
D to CP data setup time	t_{DSU}		300	–	–	ns
CP to D data hold time	t_{DH}		300	–	–	ns
LOAD to M delay time	t_{DM}		–1000	–	1000	ns

Reset characteristics at $T_a = -20$ to $+75^\circ\text{C}$

Parameter	Symbol	Conditions	Ratings			Unit
			min	typ	max	
V_{DD} rise time	t_{DDR}		1	–	100	μs
V_{DD} off time	t_{DDOFF}		1	–	–	ms

Clock Generator

The internal oscillator that generates the clock for the internal circuit requires an external feedback resistor, connection of the internal feedback resistor or an external clock input as shown in the following sections.

External clock

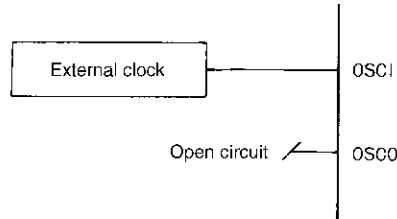

The input duty cycle should be between 45 and 55% as shown in the following figure.

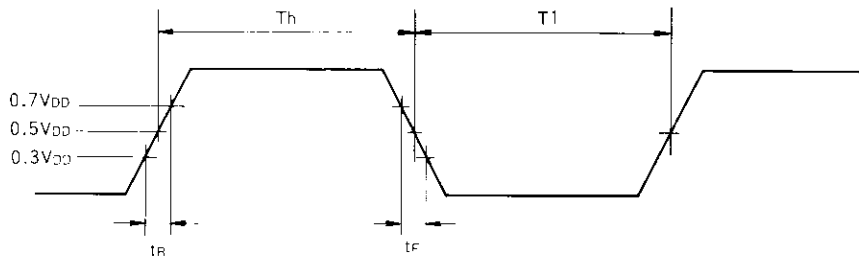

Note. $Duty = \frac{T_h}{T_h + T_l} \times 100\%$

External feedback resistor

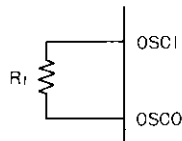

Note. The resistor should be mounted as close as possible to OSCI and OSCO.

Internal feedback resistor

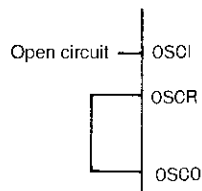

Measurement Circuit

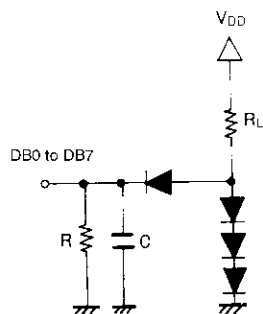

Note. $R_L = 2.4k\Omega$, $C = 130pF$, $R = 11k\Omega$

Read/write cycle timing

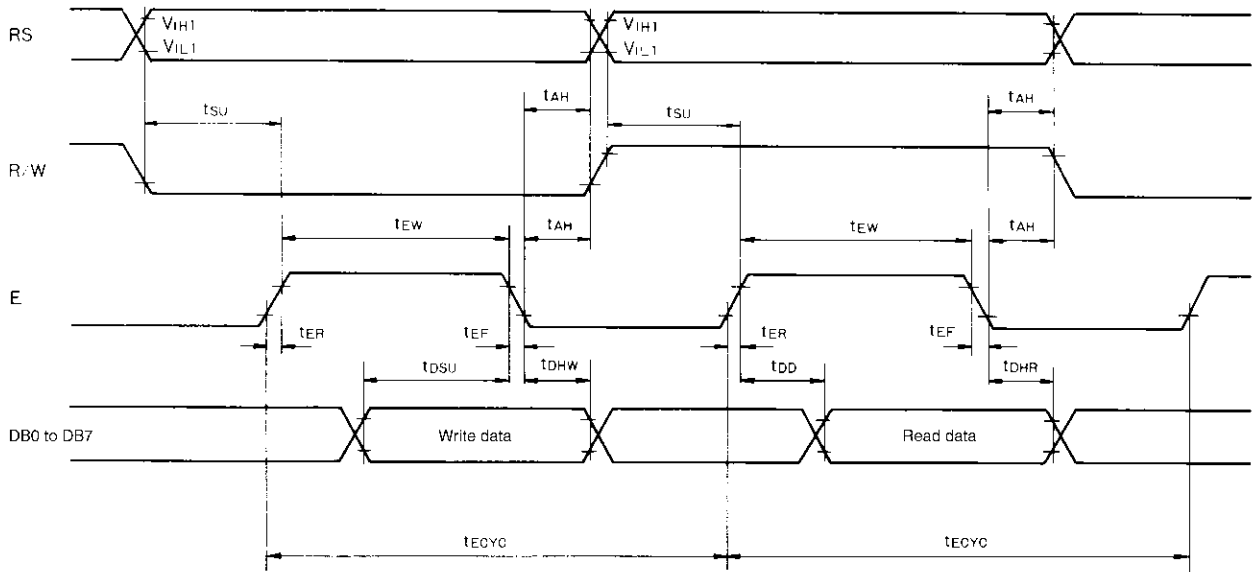

LC7930N interface timing

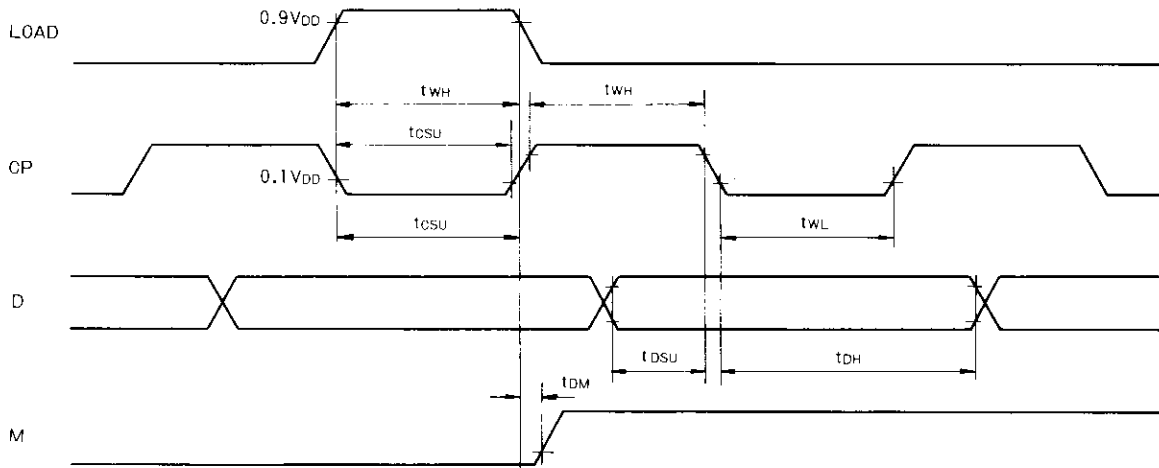

Power Supply

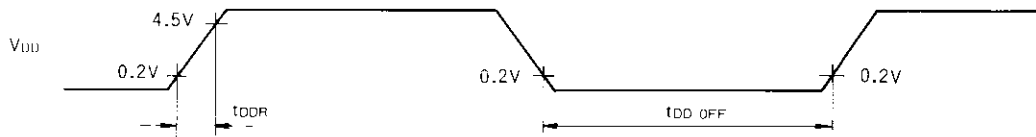

Pin Description

Name	Num	I/O	Connect to	Functions
RS	1	I	MPU	Data register or instruction register select input. Data register when "1" and instruction register when "0".
R/W	1	I	MPU	Read or write select input. Read when "1" and write when "0".
E	1	I	MPU	Execution start input
DB7 to DB4	4	I/O	MPU	4-bit microcontroller interface data bus and 8-bit microcontroller interface high-order four bits data bus connections. DB7 can also be used as busy flag.
DB3 to DB0	4	I/O	MPU	8-bit microcontroller interface low-order four bits data bus connections. No connection when 4-bit interface size is selected.
LOAD	1	O	LC7930N	D serial data shift latch output
CP	1	O	LC7930N	D serial data shift clock output
M	1	O	LC7930N	Display expansion drive signal inversion control signal output
D	1	O	LC7930N	Display expansion serial data output. Nonselected when "0" and selected when "1".
OC1 to OC16	16	O	LCD	LCD common driver outputs. OC9 to OC16 and OC12 to OC16 are unselected in 1/8 duty and 1/11 duty respectively.
OS1 to OS80	80	O	LCD	LCD segment driver outputs
V1 to V5	5		source	LCD driver reference voltage inputs
V _{DD} , GND	2		source	V _{DD} : +5V, GND : 0V
OSCI	2			Oscillator feedback resistor connection and external clock input
OSCO	2			Oscillator external feedback resistor connection
OSCR	1		OSCO	Internal feedback resistor connection. Connect to OSCI or leave open.
SHL	1	I		Segment output shift direction select input. Shift right (OS1 to OS80) when "1", and shift left (OS80 to OS1) when "0".
A/B	1	I		M output signal type select input. A-type when "1" and B-type when "0".
V1' to V5'	5	I	V _{DD} to V4	LCD drive voltage internal voltage divider outputs. Leave open if the the voltage divider is not used.

Functional Description

Registers

The LC7986C has two 8-bit registers—instruction register (IR) and data register (DR)—that are selected as shown in the following table.

RS	RAW	Operation
0	0	IR write, instruction execution
0	1	Busy flag (DB7) and address counter (DB0 to DB6) output
1	0	DR write, internal DR to DD RAM or CG RAM data transfer
1	1	DR read, internal DD RAM or CG RAM to DR data transfer

The instruction register is write-only. It contains instruction codes or DD RAM and CG RAM addresses written by the microcontroller.

Busy Flag

When busy flag is 1, the previous instruction is executing, and when 0, the instruction has completed. The next instruction cannot be received until BF is 0. The microcontroller should, therefore, confirm that BF is 0 before writing the next instruction.

Display Data RAM (DD RAM)

The display data RAM stores 80, 8-bit character codes, and the LC7986C can display a maximum of 80 characters. The address counter contains the location for the next display memory read or write operation as shown in the following figure.

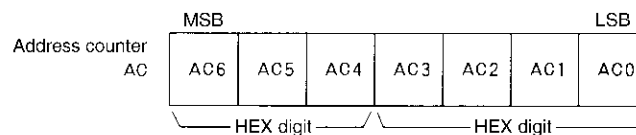

Display data addresses are in hexadecimal. For example, the address counter contents for location 4E are shown in the following figure.

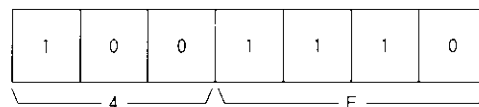

To prevent undesirable effects such as display flicker during DD RAM accesses, the internal memory and the microprocessor interface have separate timing signals.

Single-line display mode (N = 0)

The DD RAM addresses and their corresponding display positions for an 80-character display are shown in the following figure.

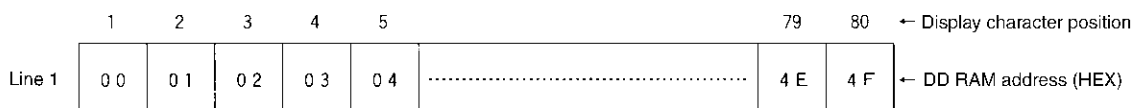

LC7986C

A single LC7986C, however, can drive 16 characters. The display positions and DD RAM addresses for an unshifted 16-character display are shown in the following figure.

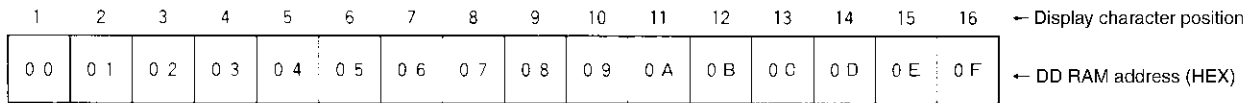

The DD RAM addresses following left and right display shifts are shown in the following figure. Note that the displayed characters wrap around from addresses 4F_H to 00_H.

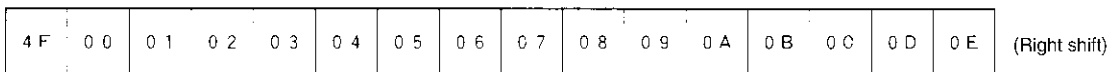
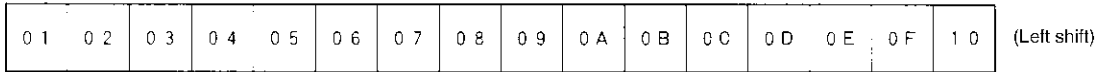

An LC7986C and a single LC7930N can drive a 16-character display. The display positions and DD RAM addresses for an unshifted display are shown in the following figure.

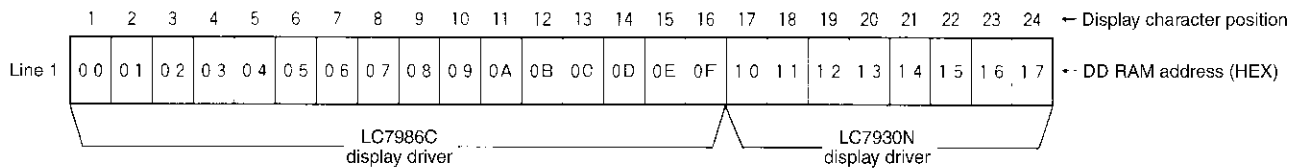

The DD RAM addresses following left and right display shifts are shown in the following figure.

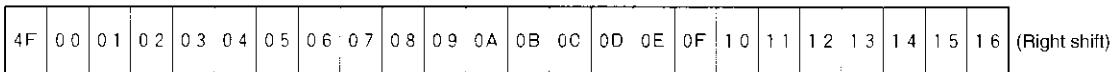
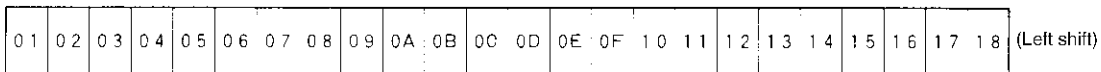

The number of displayed characters can be increased by adding more LC7930Ns. An LC7986C and eight LC7930Ns can drive an 80-character display as shown in the following figure.

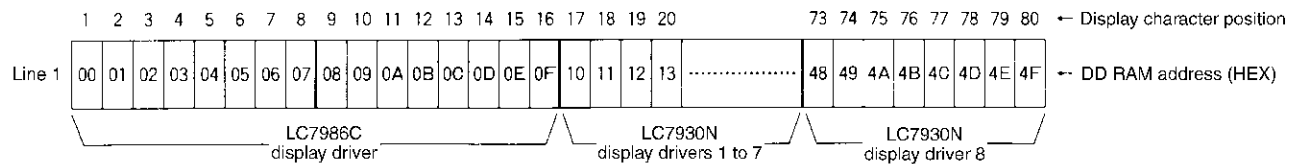

LC7986C

An LC7986C and a single LC7930N can drive a 2-line × 24-character display. The display positions and DD RAM addresses for an unshifted, 2-line × 24-character display are shown in the following figure.

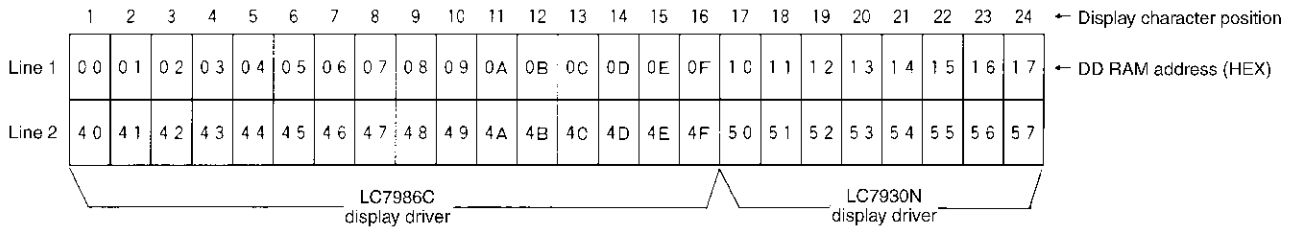

The DD RAM addresses following left and right display shifts are shown in the following figure.

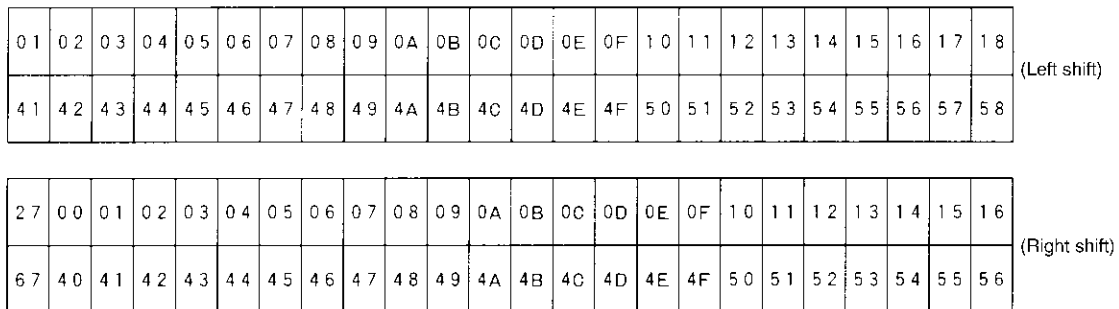

The number of displayed characters can be increased by adding more LC7930Ns. An LC7986C and three LC7930Ns can drive a 2-line × 40-character display as shown in the following figure.

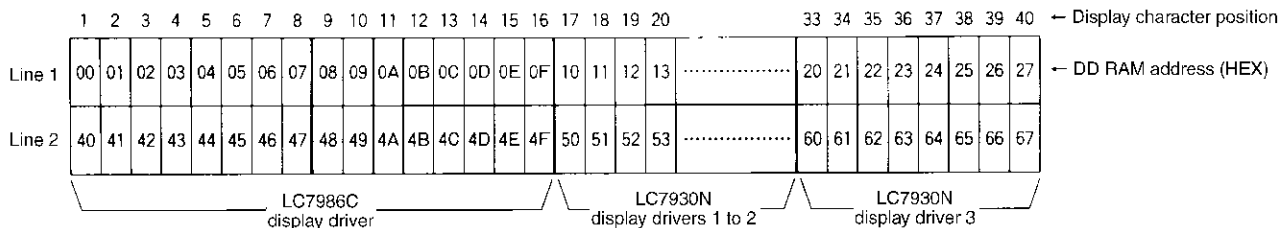

Character Generator ROM (CG ROM)

The character generator ROM contains 160, 5 × 7-pixel bitmaps and 32, 5 × 10-pixel bitmaps as shown in the following figure. The characters are selected by their 8-bit character code.

Character Generator RAM (CG RAM)

The character generator RAM stores user-defined bitmaps for either eight, 5 × 7-pixel characters or four, 5 × 10-pixel characters. To display character patterns stored in CG RAM, write the character codes, shown in the leftmost column of the following figure, on DD RAM.

Character cord and the character bitmap

Upper Lower 4bit 4bit	0000	0010	0011	0100	0101	0110	0111	1010	1011	1100	1101	1110	1111
xxxx0000	CG RAM (1)		Q	R	P	Q	P		Q	R	Q	R	P
xxxx0001	(2)	!	Q	R	Q	R	Q	R	Q	R	Q	R	Q
xxxx0010	(3)	"	Z	R	R	Q	P	T	Q	R	Q	R	P
xxxx0011	(4)	#	S	S	S	S	S	S	S	S	S	S	S
xxxx0100	(5)	\$	A	T	A	T	A	T	A	T	A	T	A
xxxx0101	(6)	%	S	S	S	S	S	S	S	S	S	S	S
xxxx0110	(7)	&	F	V	V	V	V	V	V	V	V	V	V
xxxx0111	(8)	'	Z	A	A	A	A	A	A	A	A	A	A
xxxx1000	(1)	(C	A	A	A	A	A	A	A	A	A	A
xxxx1001	(2))	S	T	V	V	V	V	V	V	V	V	V
xxxx1010	(3)	*	J	Z	Z	Z	Z	Z	Z	Z	Z	Z	Z
xxxx1011	(4)	+	K	K	K	K	K	K	K	K	K	K	K
xxxx1100	(5)	,	L	L	L	L	L	L	L	L	L	L	L
xxxx1101	(6)	-	M	M	M	M	M	M	M	M	M	M	M
xxxx1110	(7)	.	N	N	N	N	N	N	N	N	N	N	N
xxxx1111	(8)	/	O	O	O	O	O	O	O	O	O	O	O

5 × 7-pixel characters

The layout and addressing for 5 × 7-pixel characters is shown in the following figure. Each character occupies eight bytes, where bits 3 to 5 of the CG RAM address correspond to bits 0 to 2 of the character code. Note that bit 3 of the character code is not significant so, for example, codes 00_H and 08_H select the same character.

Bits 0 to 2 of the CG RAM address are the bitmap row address, where row 000 is the topmost displayed row.

The cursor, when displayed, is formed by ORing the bottom row with all 1s. If the cursor is used, row 111 should

contain all 0s so the cursor does not obscure the bottom row of the character.

Bits 0 to 4 of the CG RAM data contain the character bitmaps. When a bit is 1, the corresponding pixel is ON, and when 0, the pixel is OFF.

Bits 5 to 7 of the CG RAM data are present in memory, but are not used by the display circuit. These bits can be used as general-purpose RAM.

Character code (DD RAM data)								CG RAM address								Character bitmap (CG RAM data)								
7	6	5	4	3	2	1	0	5	4	3	2	1	0	7	6	5	4	3	2	1	0			
←MSB				LSB→				←MSB				LSB→				←MSB				LSB→				
0 0 0 0 * 0 0 0								0 0 0								* * * 1 1 1 1 0								Character bitmap 1
																1 0 0 0 1								
																1 0 0 0 1								
																1 1 1 1 0								
																1 0 1 0 0								
																1 0 0 1 0								
																1 0 0 0 1								
																* * * 0 0 0 0 0								
0 0 0 0 * 0 0 1								0 0 1								* * * 1 0 0 0 1								Character bitmap 2
																0 1 0 1 0								
																1 1 1 1 1								
																0 0 1 0 0								
																1 1 1 1 1								
																0 0 1 0 0								
																0 0 1 0 0								
																* * * 0 0 0 0 0								
0 0 0 0 * 1 1 1								1 1 1								* * *								
																1 0 0								
																1 0 1								
																1 1 0								
1 1 1								* * *																

* Don't care

5 × 10-pixel characters

The layout and addressing for 5 × 10-pixel characters is shown in the following figure. Each character occupies eleven bytes, where bits 4 and 5 of the CG RAM address correspond to bits 1 and 2 of the character code. Note that bits 0 and 3 of the character code are not significant so, for example, codes 00_H, 01_H, 08_H and 09_H all select the same character.

Bits 0 to 3 of the CG RAM address are the bitmap row address where row 000 is the topmost displayed row.

The cursor, when displayed, is formed by ORing the bottom row with all 1s. If the cursor is used, row 1010 should

contain all 0s so the cursor does not obscure the bottom row of the character.

Bits 0 to 4 of the CG RAM data contain the character bitmaps. When a bit is 1, the corresponding pixel is ON, and when 0, the pixel is OFF.

Bits 5 to 7 of the CG RAM data are present in memory, but are not used by the display circuit. These bits and the CG RAM bytes, rows 1011 to 1111 that are not used by the display circuit, can be used as general-purpose RAM.

Character code (DD RAM data)								CG RAM address					Character bitmap (CG RAM data)								
7	6	5	4	3	2	1	0	5	4	3	2	1	0	7	6	5	4	3	2	1	0
←MSB→				LSB→				←MSB→		LSB→			←MSB→				LSB→				
										0	0	0	0	*	*	*	0	0	0	0	0
										0	0	0	1				0	0	0	0	0
										0	0	1	0				1	0	1	1	0
										0	0	1	1				1	1	0	0	1
										0	1	0	0				1	0	0	0	1
0	0	0	0	*	0	0	*	0	0	0	1	0	1				1	0	0	0	1
										0	1	1	0				1	1	1	1	0
										0	1	1	1				1	0	0	0	0
										1	0	0	0				1	0	0	0	0
										1	0	0	1				1	0	0	0	0
										1	0	1	0	*	*	*	0	0	0	0	0
										1	0	1	1	*	*	*	*	*	*	*	*
										1	1	0	0				*	*	*	*	*
										1	1	0	1				*	*	*	*	*
										1	1	1	0				*	*	*	*	*
										1	1	1	1	*	*	*	*	*	*	*	*
										0	0	0	0	*	*	*					
										0	0	0	1	*	*	*					
0	0	0	0	*	1	1	*	1	1	1	0	0	1				*	*	*	*	*
										1	0	1	0	*	*	*	*	*	*	*	*
										1	0	1	1				*	*	*	*	*
										1	1	0	1				*	*	*	*	*
										1	1	1	0				*	*	*	*	*
										1	1	1	1	*	*	*	*	*	*	*	*

* Don't care

Timing Generator

This circuit generates timing signals both for internal circuit operation and for driving external LC7930Ns. The timing signals for the DD RAM, CG ROM and CG RAM are independent of the microcontroller interface so that memory accesses by the microcontroller do not cause interference with the display drive signals.

Display Drivers

The LC7986C incorporates 16 LCD common driver outputs and 80 LCD segment driver outputs. The character font and the number of display lines determine the number of active common outputs.

The segment drivers function identically to the LC7930N segment drivers. The character bitmap data to be displayed is latched in the internal 80-bit shift register before being output on the segment drivers.

The display bitmap data for each pixel-row is generated starting with the left-most or the right-most pixel. The shift direction is set using SHL. The data shifts through the shift register and is output on the shift register serial data output. The shift register latches the last 80 bits in the row so the LC7986C displays the last 16 characters. External LC7930Ns connect in series to the serial data output and each one latches and displays bitmap data for eight additional characters.

Cursor Display and Blinking

Cursor display and blinking of the character at the cursor position are controlled using the Display ON/OFF instruction. The cursor position is at the character corresponding to the address counter value as shown in the following figure.

Note that the cursor and blinking character are also displayed at the address counter value when CG RAM is selected.

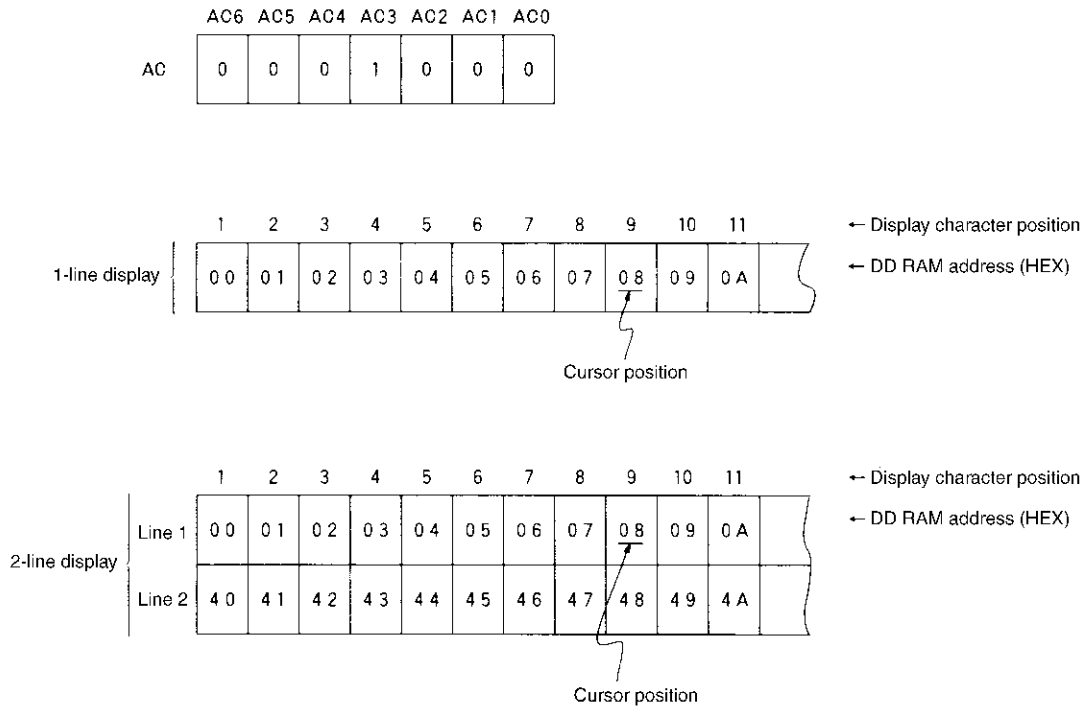

Microcontroller Interface

DB0 to DB7 are used for the 4-bit data bus. Two read or write cycles, therefore, are required to transfer each data, status or instruction byte. The high-order four bits—bits DB4 to DB7 in 8-bit interface mode—are transferred first. The low-order four bits are then transferred as shown in the following figure.

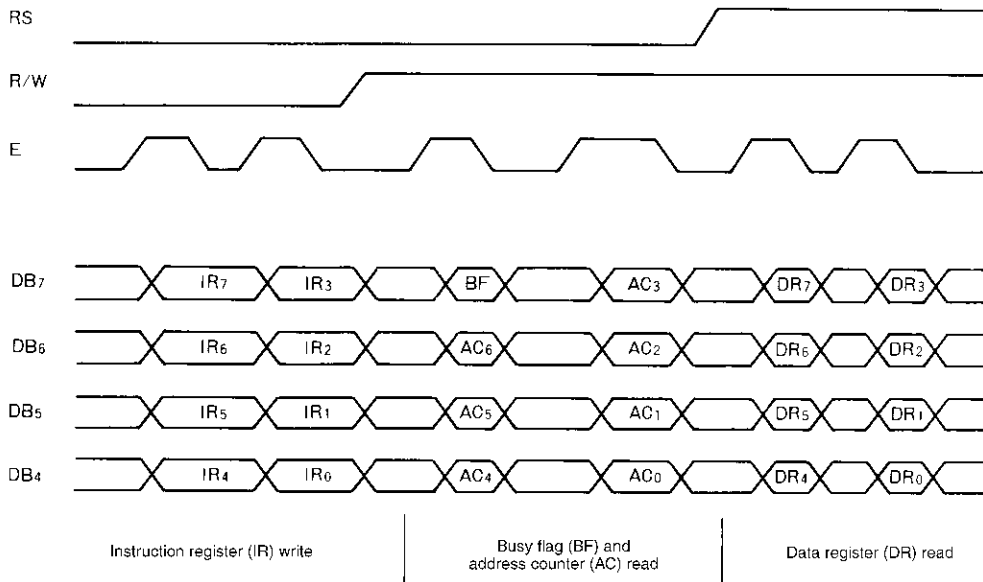

Reset Circuit

The internal reset circuit initializes the LC7986C at power-ON. The busy flag remains ON from power-ON until initialization is complete 10ms after V_{DD} reaches 4.5V. Note that if power supply conditions are such that the internal reset circuit does not operate to initialize the device, the LC7986C must be initialized using commands from the microcontroller.

The initialization sequence is as follows.

1. Clear Display
2. Set Function ($D/L = 1, N = 0, F = 0$)
Sets 8-bit interface size, 1-line display size and 5×7 -pixel character font.
3. Cursor/Display Control ($D = 0, C = 0, B = 0$)
Sets the display, the cursor and character blinking OFF.
4. Set Entry Mode ($I/D = 1, S = 0$)
Sets address counter auto-increment and sets display shift OFF.

Instructions

The external microcontroller accesses two register—instruction register and data register—to control the LC7986C. So the microcontroller interface is independent of the microcontroller clock frequency, the LC7986C stores the instruction of data internally before executing it.

There are four types of instructions.

- Function set instructions such as display type or interface size set
- Address set instructions
- Data read and write instructions
- Other instructions

The Busy Flag/Address Read instruction is the only instruction that can be executed while the LC7986C is executing a previous instruction. Before transmitting any

other instruction, the microcontroller should either check that the busy flag is OFF or else wait longer than the execution time of the previous instruction.

Data read and write instructions are usually the most frequently used instructions. For increased microcontroller efficiency, a display shift and display data write can be executed simultaneously. In addition, the address counter automatically increments or decrements after either a data read or data write instruction, which reduces the operations required by the microcontroller. Note that the increment or decrement occurs after the busy flag turns OFF. The delay until the address counter updates is $t_{ADD} = 1.5/f_{CP}$ or $t_{ADD} = 1.5/f_{OSC}$, and is shown in the following figure.

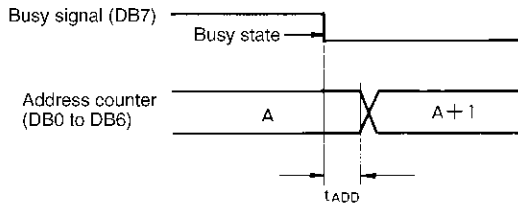

The instructions are shown in the following table. The instruction code comprises the RS, R/W and DB0 to DB7 signals.

Instruction	Code										Description	Execution time*1 (max) (f_{CP} or $f_{OSC} = 320kHz$)
	RS	R/W	DB7	DB6	DB5	DB4	DB3	DB2	DB1	DB0		
Display Clear	0	0	0	0	0	0	0	0	0	1	Clears the display and sets the address counter to DD RAM address 0.	1.28ms
Cursor Home	0	0	0	0	0	0	0	0	1	×	Sets the address counter to DD RAM address 0. Returns a shifted display to the original position. Does not alter the DD RAM data	1.28ms
Set Entry Mode	0	0	0	0	0	0	0	1	I/D	S	Sets cursor movement and display shift following a data read or write. When I/D is 1, the cursor increments, and when 0, decrements. When S is 1, the display also shifts.	31 μ s
Display ON/OFF	0	0	0	0	0	0	1	D	C	B	When D is 1, the display is ON, and when 0, OFF. When C is 1, the cursor is ON, and when 0, OFF. When B is 1, blinking of the character at the cursor position is ON, and when 0, OFF.	31 μ s
Cursor/Display Shift	0	0	0	0	0	1	S/C	R/L	×	×	Moves the cursor or the display without altering the DD RAM data. When S/C is 1, the display shifts, and when 0, the cursor moves. When R/L is 1, the direction is right, and when 0, left.	31 μ s
Set Function	0	0	0	0	1	DL	N	F	×	×	When DL is 1, the interface size is eight bits, and when 0, four bits. When N is 1, the display size is two lines, and when 0, a single line. When F is 1, the font size is 5 × 10 pixels, and when 0, 5 × 7 pixels.	31 μ s
Set CG RAM Address	0	0	0	1	CG RAM address					Sets the CG RAM address. Data read and writes after this instruction are to and from CG RAM.	31 μ s	
Set DD RAM Address	0	0	1	DD RAM address					Sets the DD RAM address. Data read and writes after this instruction are to and from DD RAM.	31 μ s		
Busy Flag/Address Read	0	1	BF	Address counter					Used during execution of other instructions, outputs the busy flag state and the address counter value. The address counter is used for both DD RAM and CG RAM.	0 μ s		
Data Write	1	0	Write data					Writes data to DD RAM or CG RAM.	31 μ s ($t_{ADD} = 4.7\mu$ s)			
Data Read	1	1	Read data					Reads data from DD RAM or CG RAM.	31 μ s ($t_{ADD} = 4.7\mu$ s)			
	I/D = 1: increment S = 1: accompanied by display shift S/C = 1: display shift R/L = 1: right shift DL = 1: 8-bit N = 1: two rows F = 1: 5 × 10-pixel characters BF = 1: internally operating					I/D = 0: decrement S/C = 0: cursor shift R/L = 0: left shift DL = 0: 4-bit N = 0: a row F = 0: 5 × 7-pixel characters BF = 0: open to instructions					DD RAM : display data RAM CG RAM : character generator RAM A_{CG} : CG RAM address A_{DD} : DD RAM address: corresponding to cursor address AC : address counter used for both DD RAM and CG RAM	

Note: *1. The execution time depends on the operating frequency. For example, if f_{CP} or $f_{OSC} = 270kHz$, the execution time is $31\mu s \times 320/270 = 37\mu s$.

Display Clear

	RS	R/W	DB ₇	DB ₀					
Code	0	0	0	0	0	0	0	0	0	1

Fills the DD RAM with space characters (20_H), returns the display to the unshifted position and sets the address counter to zero, returning the cursor to the top-left display position. The address counter increment/decrement mode is set to increment. The character blinking and display shift modes are not affected.

Note that if a custom character generator ROM is used, the space character must correspond to the 20_H character code for the display to be cleared correctly.

Cursor Home

	RS	R/W	DB ₇	DB ₀					
Code	0	0	0	0	0	0	0	0	1	*

* Don't care

Returns the display to the unshifted position and sets the address counter to zero, returning the cursor to the top-left display position. Does not alter the DD RAM data.

Set Entry Mode

	RS	R/W	DB ₇	DB ₀					
Code	0	0	0	0	0	0	0	1	I/D	S

Sets the cursor auto-increment direction and the display shift mode and direction. When I/D is 1, the address counter increments when data is read from or written to either the DD RAM or the CG RAM, thereby shifting the cursor right one character position. When I/D is 0, the address counter decrements, shifting the cursor left.

When S is 1, display shift is ON, and the display also shifts one character position to the right or left when data is written to the DD RAM so that the cursor position relative to the display is unchanged. No display shift occurs when data is read from the DD RAM or when data is read from or written to the CG RAM, although the address counter increments or decrements for all read and write operations. When S is 0, display shift is OFF.

Display ON/OFF

	RS	R/W	DB ₇	DB ₀					
Code	0	0	0	0	0	0	1	D	C	B

Sets the display, the cursor and character blinking ON or OFF.

When D is 1, the display is ON, and when 0, OFF. Setting the display ON or OFF does not alter the address counter or the DD RAM data.

When C is 1, the cursor is ON, and when 0, OFF. Setting the cursor ON or OFF does not affect the cursor auto-increment and display shift modes.

When B is 1, the cursor and the character at the cursor position blink, alternating between black (all pixels ON) and the displayed character as shown in the following figure. When f_{CP} or $f_{OSC} = 320\text{kHz}$, the blink interval is 320ms, and when f_{CP} or $f_{OSC} = 270\text{kHz}$, 379.2ms.

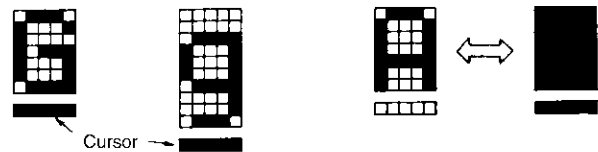

5 x 7-pixel character

5 x 10-pixel character

Alternating display

(a) Cursor display

(b) Character blinking display

Cursor/Display Shift

	RS	R/W	DB ₇	DB ₀					
Code	0	0	0	0	0	1	S/C	R/L	*	*

* Don't care

Shifts the cursor or the display either left or right as shown in the following table. A DD RAM write is not required.

When shifting a 2-line display, both rows shift simultaneously, but characters do not move from one row to another. Each time the display shifts, the characters in each row only move within the row.

S/C	R/L	Description
0	0	Decrements the address counter and shifts the cursor left. (-1 at AC)
0	1	Increments the address counter and shifts the cursor right. (+1 at AC)
1	0	Shifts the display left. The address counter does not change, and the cursor moves with the display.
1	1	Shifts the display right. The address counter does not change, and the cursor moves with the display.

Set Function

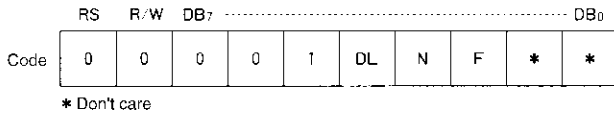

Sets the microcontroller interface bus size and the display mode. When DL is 1, the interface size is eight bits, and when 0, four bits. When the interface size is four bits, two reads or writes of the high-order bits of the data bus, DB4 toB7, are required.

N and F set the display mode as shown in the following table. N sets the number of lines in the display, and F, the font size. Note that a 2-line display cannot use the 5 × 10-pixel font size.

N	F	Display lines	Font size (pixels)	Duty
0	0	1	5 × 7	1/8
0	1	1	5 × 10	1/11
1	×	2	5 × 7	1/16

Caution :

The font size and number of lines cannot be changed once any other instruction is executed following the Set Function instruction.

Set CG RAM Address

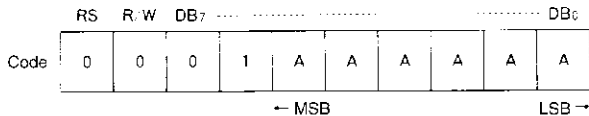

Loads the 6-bit character generator RAM address into the address counter. Data reads and writes after this instruction is executed are to and from the CG RAM.

Set DD RAM Address

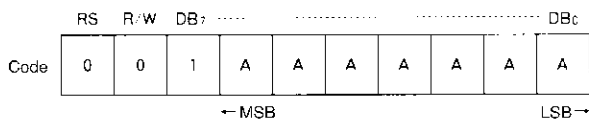

Loads the 7-bit display data RAM address into the address counter. Data reads and writes after this instruction is executed are to and from the DD RAM.

Busy Flag/Address Read

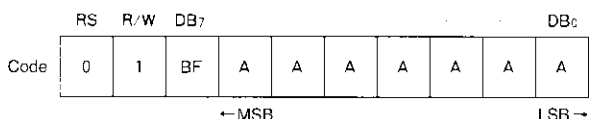

Outputs the busy flag state and the address counter value. The busy flag is used to check if the previous instruction

has finished executing. When BF is 1, the previous instruction is executing, and when 0, the instruction has completed. The next instruction cannot be received until BF is 0. The microcontroller should, therefore, confirm that BF is 0 before writing the next instruction.

The address counter is used for both the DD RAM and the CG RAM. The address output on DB0 to DB7 is the counter value before the currently executing instruction began.

Data Write

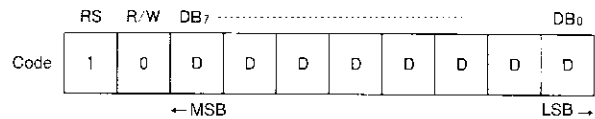

Writes the 8-bit data on DB0 to DB7 to either the DD RAM or the CG RAM, according to whether a Set DD RAM Address or a Set CG RAM Address instruction was executed previously. After writing, the address counter automatically increments or decrements according to the entry mode setting, and the display can also shift.

Data Read

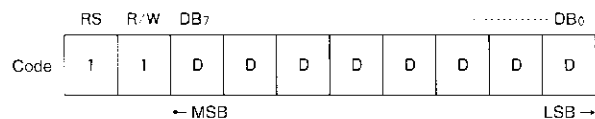

Outputs 8-bit data on DB0 to DB7 from either the DD RAM or the CG RAM, according to whether a Set DD RAM Address or a Set CG RAM Address instruction was executed previously. After the data is read, the address counter automatically increments or decrements according to the entry mode setting, but the display does not shift.

Note that a Set DD RAM Address or Set CG RAM Address instruction should be executed before executing this command. If a Data Read instruction is executed without first executing an address set instruction, the output data will not be valid. If the instruction is repeated, however, the output data will be valid data from the next address. Subsequent Data Read instructions will output valid data.

The output data will not be valid if this command is executed following a Data Write command, even though the address counter has just incremented or decremented.

A Cursor/Display Shift instruction has the same effect as a Set DD RAM Address instruction. If a Cursor/Display Shift instruction moves the cursor, an address set instruction does not have to be executed before the Data Read instruction, and the data is read from the DD RAM.

Microcontroller Interface

The LC7986C interfaces to both 4-bit and 8-bit microcontrollers.

8-bit interface

DB0 to DB7 are used for the 8-bit data bus. The timing sequence for instruction write, instruction execution, and busy flag checking is shown in the following figure.

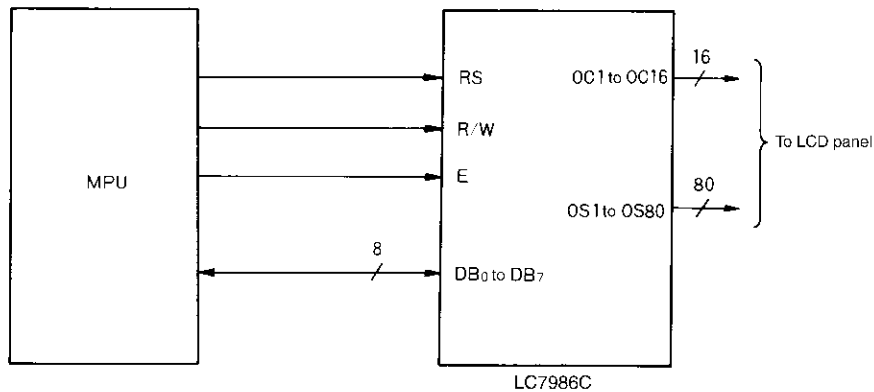
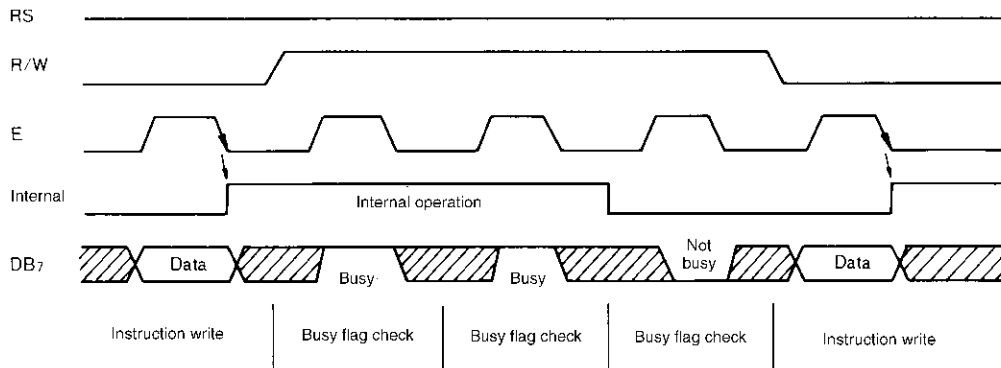

4-bit interface

The timing sequence for instruction write, instruction execution and busy flag checking is shown in the following figure. The busy flag is checked after transferring two 4-bit sets of data. The busy flag and address counter value are output as two 4-bit words. Checking the busy flag, therefore, requires two read cycles so the low-order four bits of the address counter value are flushed from the data buffer.

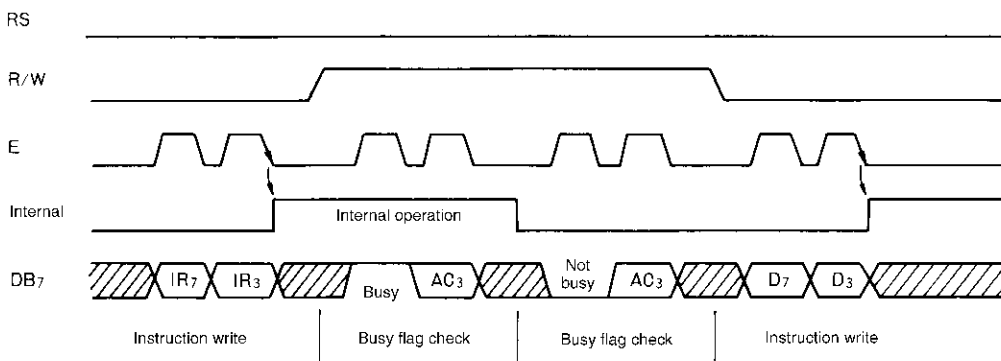

Note. IR7 and IR3 are the 7th and 3rd bit, respectively, of the instruction. AC3 is the 3rd bit of the address counter.

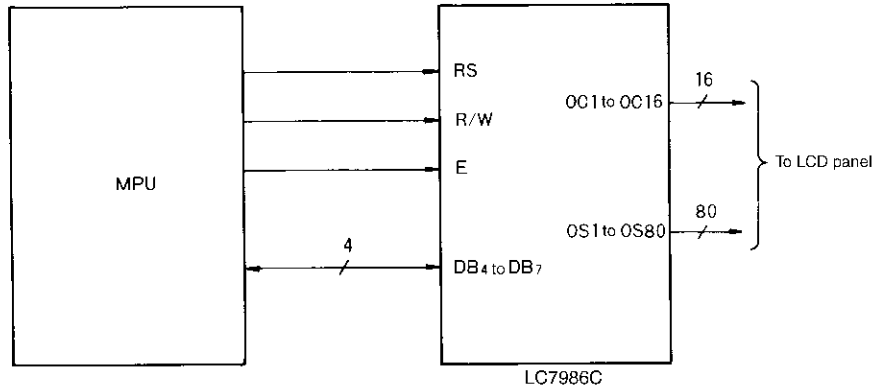

LCD Interface

The number of common signals and the duty cycle for each combination of font and display lines are shown in the following table. One common signal is required for each pixel-row in the character, and an additional common signal is required for the cursor row beneath the character.

Display lines	Font size	Common signals	Duty
1	5 × 7-pixel + cursor	8	1/8
1	5 × 10-pixel + cursor	11	1/11
2	5 × 7-pixel + cursor	16	1/16

Sample Application Circuits

1-line × 16-character, 1/4-bias and 1/8-duty Display with 5 × 7-pixel Font

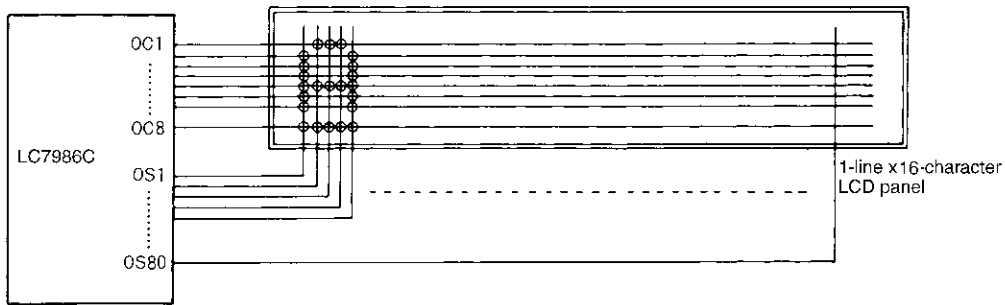

1-line × 16-character, 1/4-bias and 1/11-duty Display with 5 × 10-pixel Font

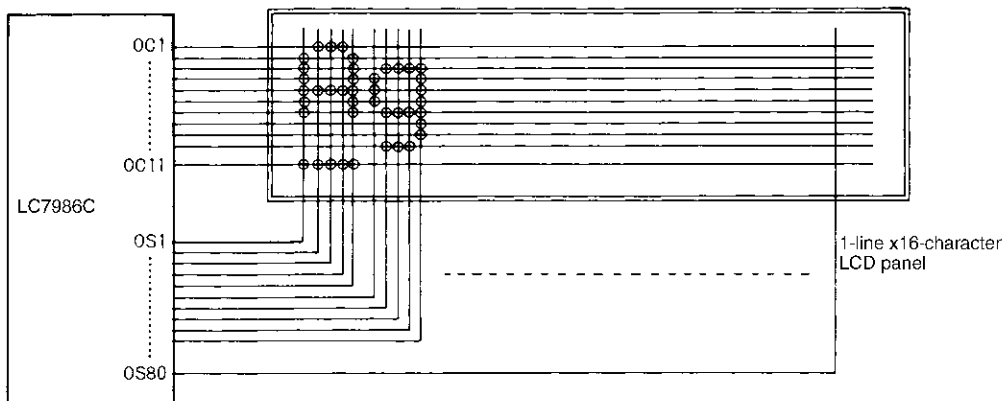

2-line × 16-character, 1/5-bias and 1/6-duty Display with 5 × 7-pixel Font

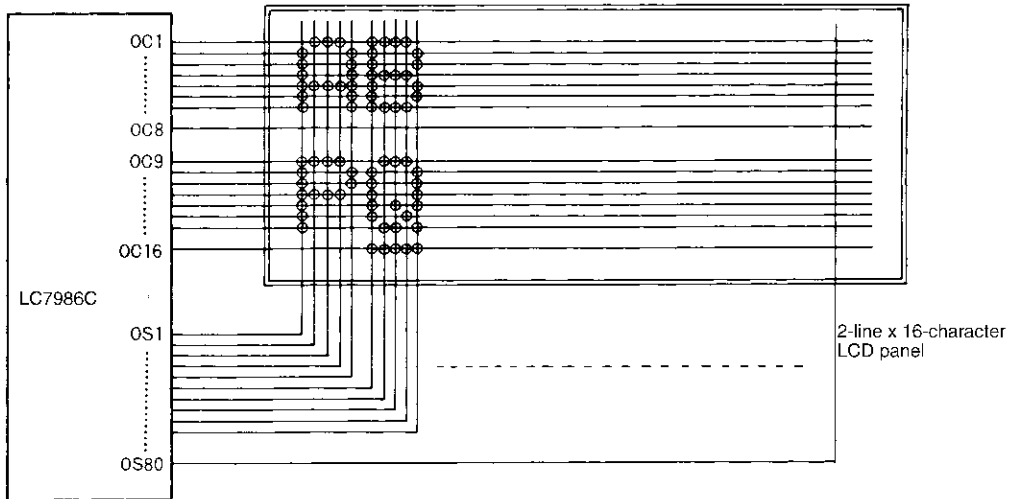

Connecting Unused Display Rows

Connecting unused LCD panel common pins to an unused LC7986C common output pin as shown in the following figure prevents crosstalk from the active drive signals affecting the display.

1-line × 16-character, 1/4-bias and 1/8-duty Display with 5 × 7-pixel Font

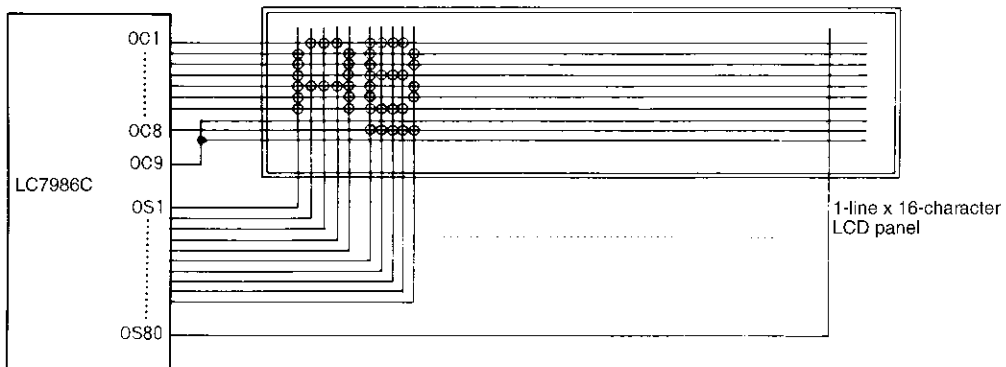

Alternative Display Connections

The LC7986C to LCD panel connections can be varied to match the LCD panel matrix as shown in the following sections.

1-line × 32-character, 1/5-bias and 1/16-duty Display with 5 × 7-pixel Font

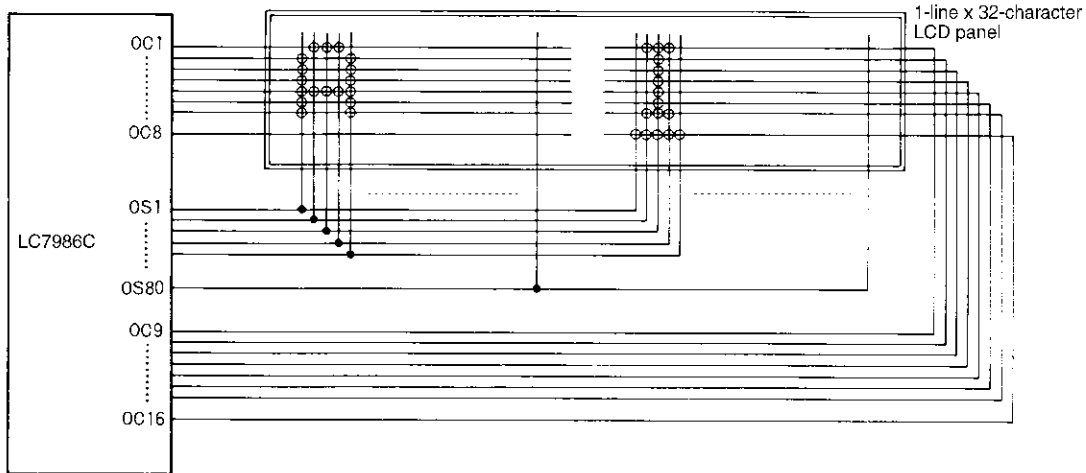

2-line × 8-character, 1/4-bias and 1/8-duty Display with 5 × 7-pixel Font

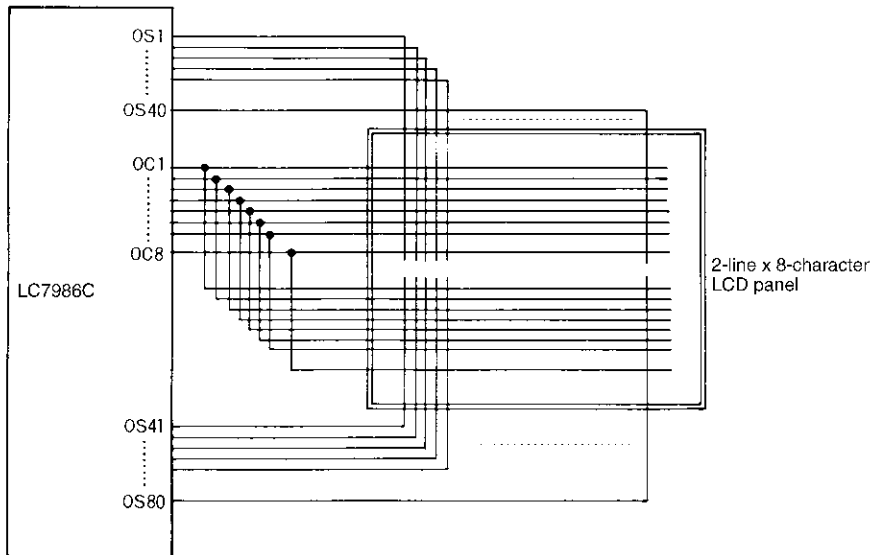

LCD driver power supply

The reference voltage levels required to generate the LCD drive waveforms are shown in the following table.

Voltages V_1 to V_5 are input on pins $V1$ to $V5$, respectively. The voltages can be produced using a voltage-divider resistor network. The voltages required depend upon the duty cycle. Connect V_{DD} to $V1'$, $V1$ to $V2'$, $V2$ to $V3'$, $V3$ to $V4'$, $V4$ to $V5'$ when using 1/5-bias drive. V_{LCD} is the LCD driver peak voltage, where $V_{LCD} = V_{DD} - V_5$.

Voltage	1/4 bias and 1/8 or 1/11 duty	1/5 bias and 1/16 duty
V_1	$V_{DD} - 0.25V_{LCD}$	$V_{DD} - 0.2V_{LCD}$
V_2	$V_{DD} - 0.5V_{LCD}$	$V_{DD} - 0.4V_{LCD}$
V_3	$V_{DD} - 0.5V_{LCD}$	$V_{DD} - 0.6V_{LCD}$
V_4	$V_{DD} - 0.75V_{LCD}$	$V_{DD} - 0.8V_{LCD}$
V_5	$V_{DD} - V_{LCD}$	$V_{DD} - V_{LCD}$

The LCD drive waveforms are shown in the following sections. The calculations assume a 320kHz clock frequency for a 4μs clock period.

A-type (A/B = HIGH)

1/8 duty LCD drive

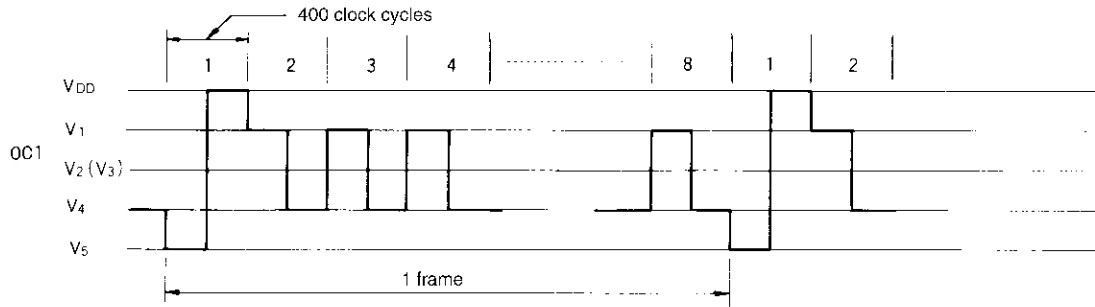

$$1 \text{ frame} = 3.125 (\mu\text{s}) \times 400 \times 8 = 10000 (\mu\text{s}) = 10 (\text{ms})$$

$$\text{Frame frequency} = \frac{1}{10 (\text{ms})} = 100 (\text{Hz})$$

1/11 duty LCD drive

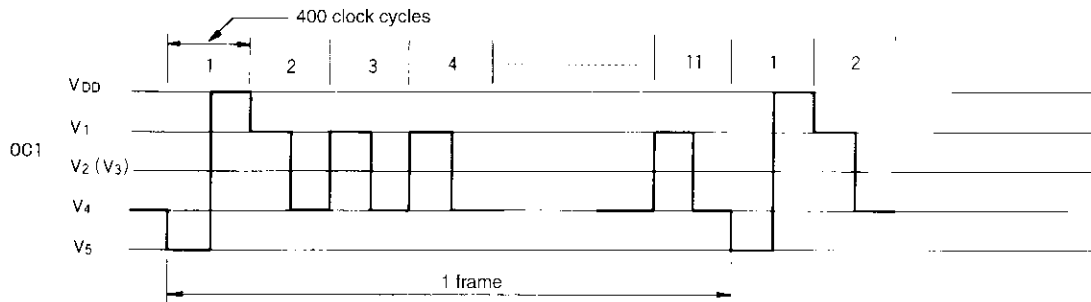

$$1 \text{ frame} = 3.125 (\mu\text{s}) \times 400 \times 11 = 13750 (\mu\text{s}) = 13.75 (\text{ms})$$

$$\text{Frame frequency} = \frac{1}{13.75 (\text{ms})} = 72.7 (\text{Hz})$$

1/16 duty LCD drive

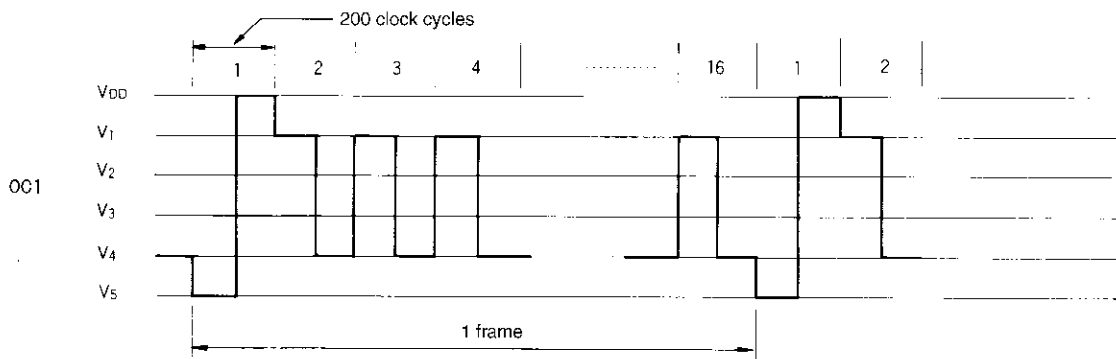

$$1 \text{ frame} = 3.125 (\mu\text{s}) \times 200 \times 16 = 10000 (\mu\text{s}) = 10 (\text{ms})$$

$$\text{Frame frequency} = \frac{1}{10 (\text{ms})} = 100 (\text{Hz})$$

B-type (A/B = LOW)

1/8 duty LCD drive

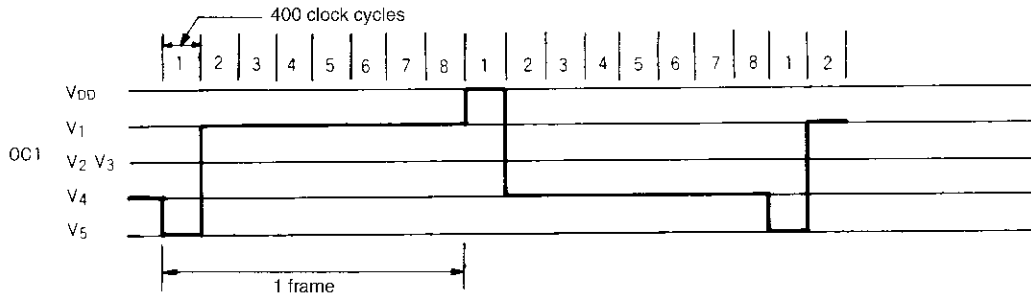

$$1 \text{ frame} = 3.125 \mu\text{s} \times 400 \times 8 = 10000 \mu\text{s} = 10 \text{ ms}$$

$$\text{Frame frequency} = \frac{1}{10 \text{ ms}} = 100 \text{ Hz}$$

1/11 duty LCD drive

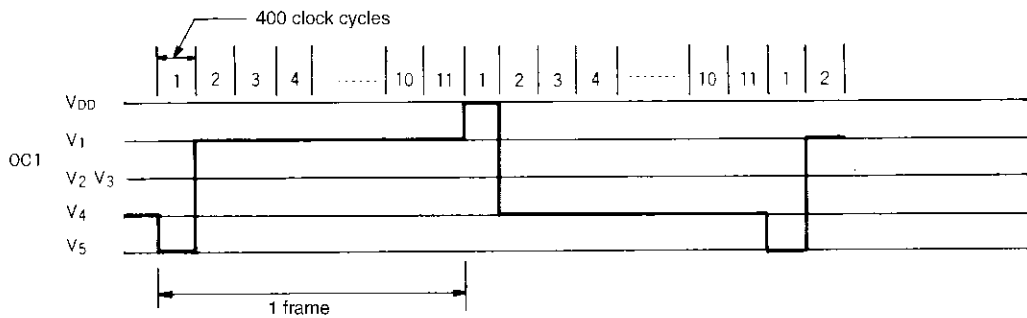

$$1 \text{ frame} = 3.125 \mu\text{s} \times 400 \times 11 = 13750 \mu\text{s} = 13.75 \text{ ms}$$

$$\text{Frame frequency} = \frac{1}{13.75 \text{ ms}} = 72.7 \text{ Hz}$$

1/16 duty LCD drive

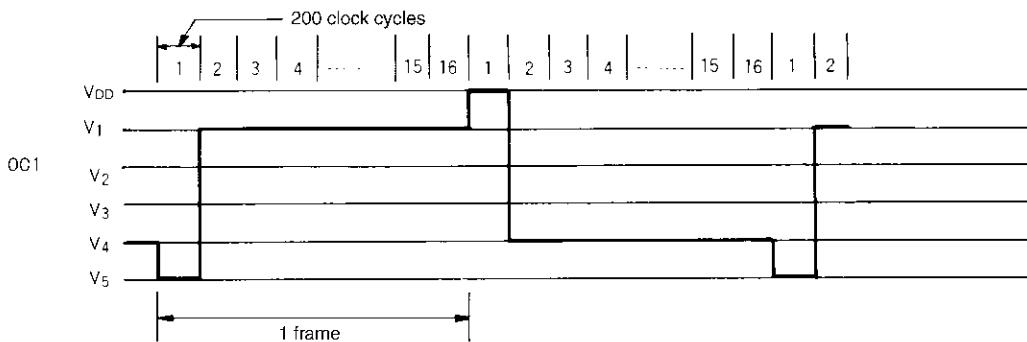

$$1 \text{ frame} = 3.125 \mu\text{s} \times 200 \times 16 = 10000 \mu\text{s} = 10 \text{ ms}$$

$$\text{Frame frequency} = \frac{1}{10 \text{ ms}} = 100 \text{ Hz}$$

LC7930N Interface

When using a single-line display, up to eight LC7930Ns, and when using a two-line display, up to three LC7930Ns can interface to the LC7986C using the circuit shown in the following figure. The LC7986C LOAD, CP, M and D

outputs connect directly to the LC7930Ns. Take care that the V1 to V5 voltage reference outputs are connected correctly to the LC7930Ns.

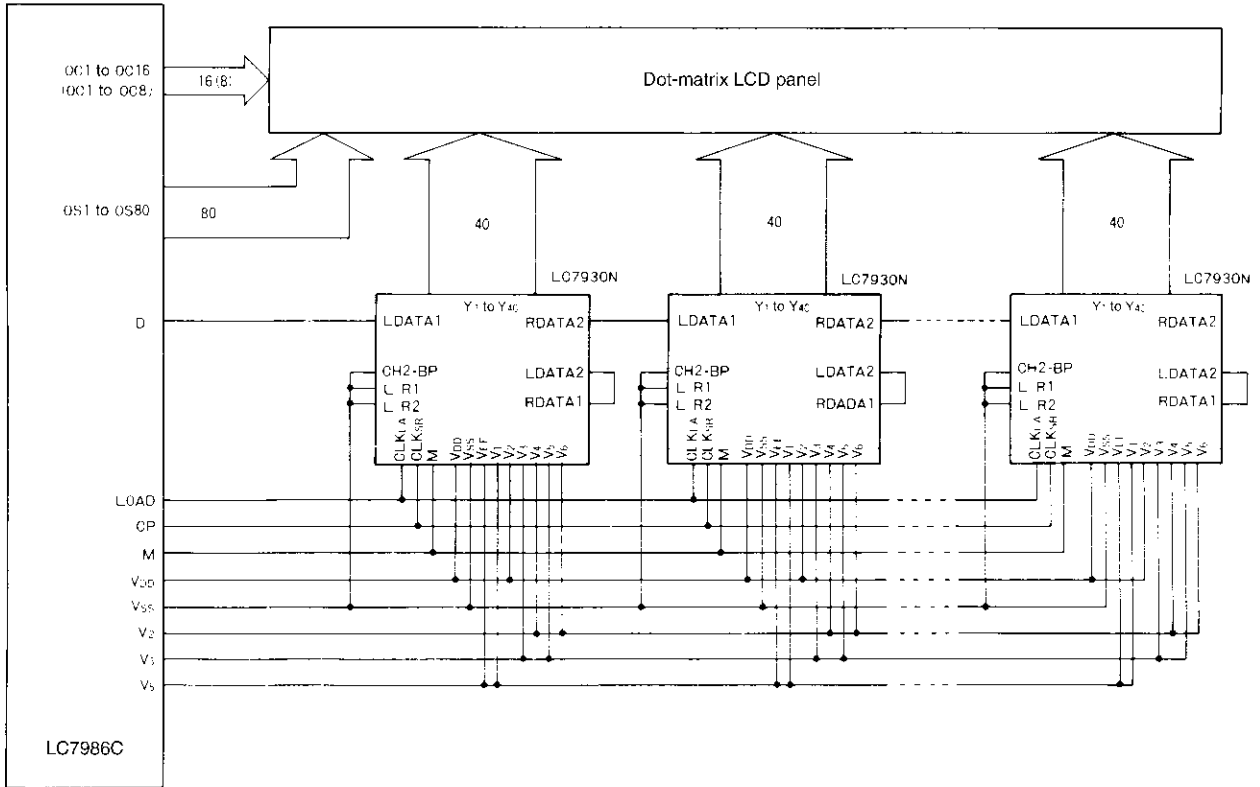

Examples

8-bit interface size, 1-line × 16-character display and internal reset circuit

The programming example is shown in the following table. This example assumes that the internal reset circuit initializes the LC7986C.

The Set Function instruction that is executed before the display is turned ON determines the operation of the device.

Since the DD RAM stores 80 characters, the display shift function can be used as shown in the example. Note that display shifts only change the display position and do not alter the DD RAM. Using the Cursor Home instruction, therefore, returns the display to its original position.

Instruction	Code										Display	Description
	RS	R/W	DB7	DB6	DB5	DB4	DB3	DB2	DB1	DB0		
Power-ON												The internal reset circuit initializes the LC7986C. The display is OFF.
Set Function	0	0	0	0	1	1	0	0	×	×		Sets 8-bit interface size, 1-line display size and 5 × 7-pixel character font. The number of display lines and the character font cannot be changed later.
Display ON/OFF	0	0	0	0	0	0	1	1	1	0		Turns the display ON and enables the cursor. The display is blank.
Set Entry Mode	0	0	0	0	0	0	0	1	1	0		Sets address auto-increment and automatic cursor right shift on writing to DD RAM or CG RAM. The display is not shifted.
Data Write	1	0	0	1	0	0	1	1	0	0		Writes 'L' to DD RAM, since DD RAM was selected when the LC7986C was initialized at power-ON. The cursor position increments and the cursor moves right.
Data Write	1	0	0	1	0	0	0	0	1	1		Writes 'C'.
Data Write	↓										↓	↓
Data Write	1	0	0	0	1	1	0	1	0	1		Writes '5'.
Set Entry Mode	0	0	0	0	0	0	0	1	1	1		Sets display shift on writing to DD RAM.
Data Write	1	0	0	0	1	0	0	0	0	0		Writes a space ' '.
Data Write	1	0	0	1	0	0	1	1	0	0		Writes 'L'.
Data Write	↓										↓	↓
Data Write	1	0	0	1	0	0	1	1	1	1		Writes 'O'.
Cursor/Display Shift	0	0	0	0	0	1	0	0	×	×		Shifts the cursor left.
Cursor/Display Shift	0	0	0	0	0	1	0	0	×	×		Shifts the cursor left.
Data Write	1	0	0	1	0	0	0	0	1	1		Writes 'C', the correct character. The display scrolls left.
Cursor/Display Shift	0	0	0	0	0	1	1	1	×	×		Shifts both the display and the cursor right.
Cursor/Display Shift	0	0	0	0	0	1	0	1	×	×		Shifts the cursor right.
Data Write	1	0	0	1	0	0	1	1	1	0		Writes 'N'.
Data Write	↓										↓	↓
Cursor Home	0	0	0	0	0	0	0	0	1	0		Sets both the display and the cursor position to 0.

8-bit interface size, 1-line × 16-character display and microcontroller initialization

The initialization sequence for an LC7986C using an 8-bit interface is shown in the following figure.

Be sure to take this initialization because in some power supply conditions the internal reset circuit does not operate.

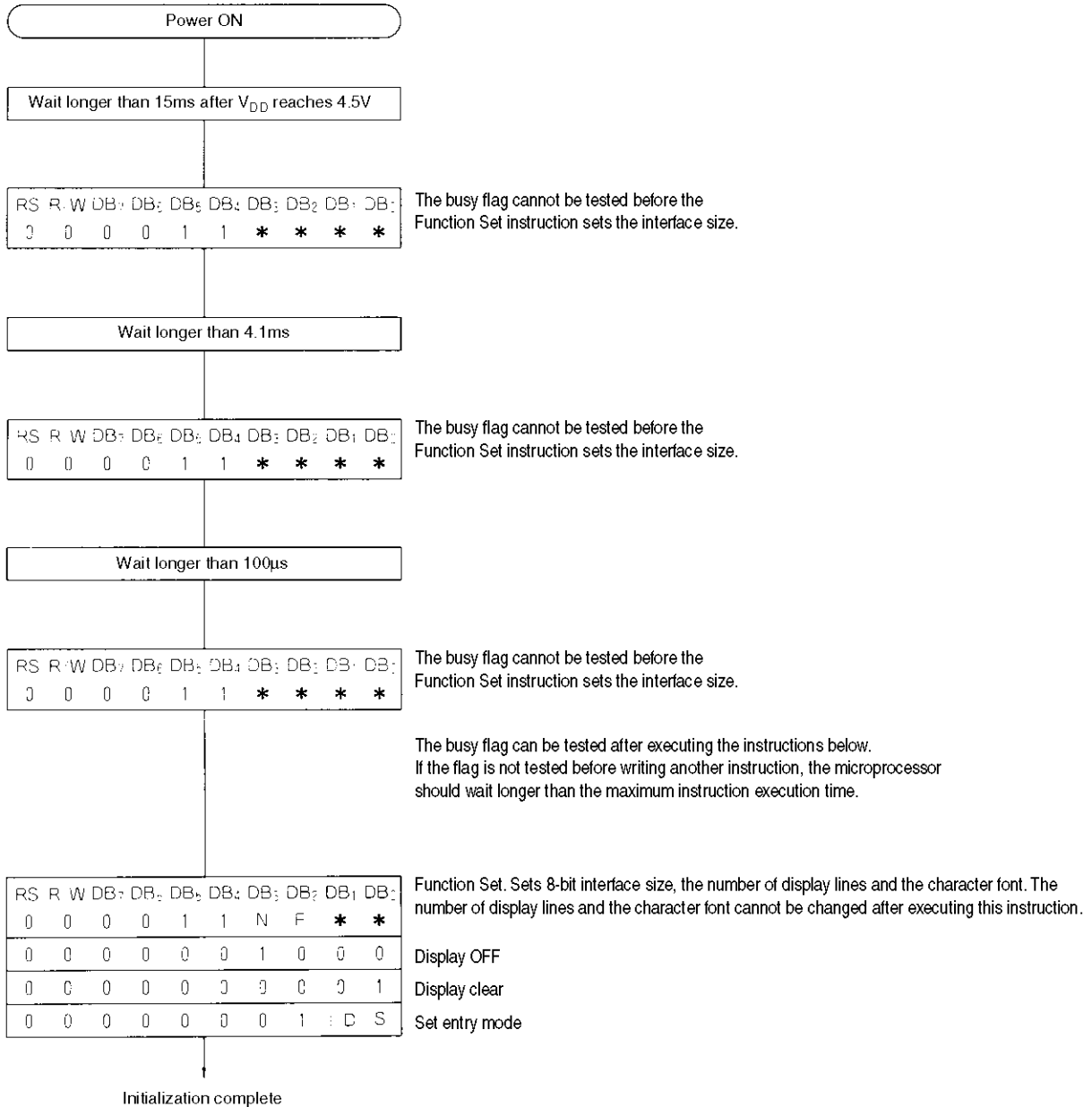



LC7986C

8-bit interface size, 2-line × 16-character display and internal reset circuit

The programming example is shown in the following table.

Note that each row uses 40 bytes of DD RAM. When the display is 16 characters long, to move the cursor from the first row to the second, the DD RAM address should be reset after the eighth character as shown in the example.

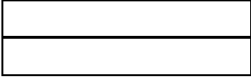
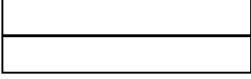
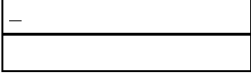
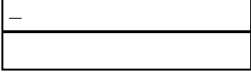
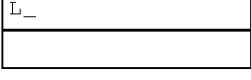
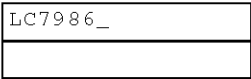
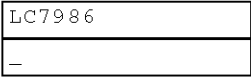
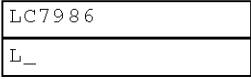
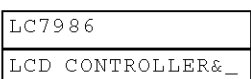
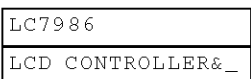
When shifting the display, both rows shift simultaneously but characters do not move from one row to another. Each time the display shifts, the characters in each row only move within the row.

Instruction	Code										Display	Description	
	RS	R/W	DB7	DB6	DB5	DB4	DB3	DB2	DB1	DB0			
Power-ON													The internal reset circuit initializes the LC7986C. The display is OFF.
Set Function	0	0	0	0	1	1	1	0	×	×			Sets 8-bit interface size, 2-line display size and 5 × 7-pixel character font.
Display ON/OFF	0	0	0	0	0	0	1	1	1	0			Turns the display ON and enables the cursor. The display is blank.
Set Entry Mode	0	0	0	0	0	0	0	1	1	0			Sets address auto-increment and automatic cursor right shift on writing to DD RAM or CG RAM. The display is not shifted.
Data Write	1	0	0	1	0	0	1	1	0	0			Writes 'L' to DD RAM, since DD RAM was selected when the LC7986C was initialized at power-ON. The cursor position increments and the cursor moves right.
Data Write	↓										↓	↓	
Data Write	1	0	0	0	1	1	0	1	0	1			Writes '5'.
Set DD RAM Address	0	0	1	1	0	0	0	0	0	0			Sets the DD RAM address to the first position in the second row.
Data Write	1	0	0	1	0	0	1	1	0	0			Writes 'L'.
Data Write	↓										↓	↓	
Data Write	1	0	0	1	0	0	1	1	1	1			Writes 'O'.
Set Entry Mode	0	0	0	0	0	0	0	1	1	1			Sets display shift on writing to DD RAM.
Data Write	1	0	0	1	0	0	1	1	1	0			Writes 'N'. The display scrolls left. The two lines scroll simultaneously.
Data Write	↓										↓	↓	
Cursor Home	0	0	0	0	0	0	0	0	1	0			Sets both the display and the cursor position to 0.

4-bit interface size, 1-line × 16-character display and microcontroller initialization

The initialization sequence for an LC7986C using a 4-bit interface is shown in the following figure.

The Function Set instruction is required to set the interface size. With a 4-bit interface size, two write accesses are required for each instruction. Since 8-bit interface size is selected when the LC7986C is initialized at power-ON,

the first write access is to an 8-bit interface on the LC7986C. DB0 to DB3 are not connected, however, and are not written. The Function Set instruction should therefore be repeated, writing DB4 to DB7 again and then DB0 to DB3, to initialize the device.

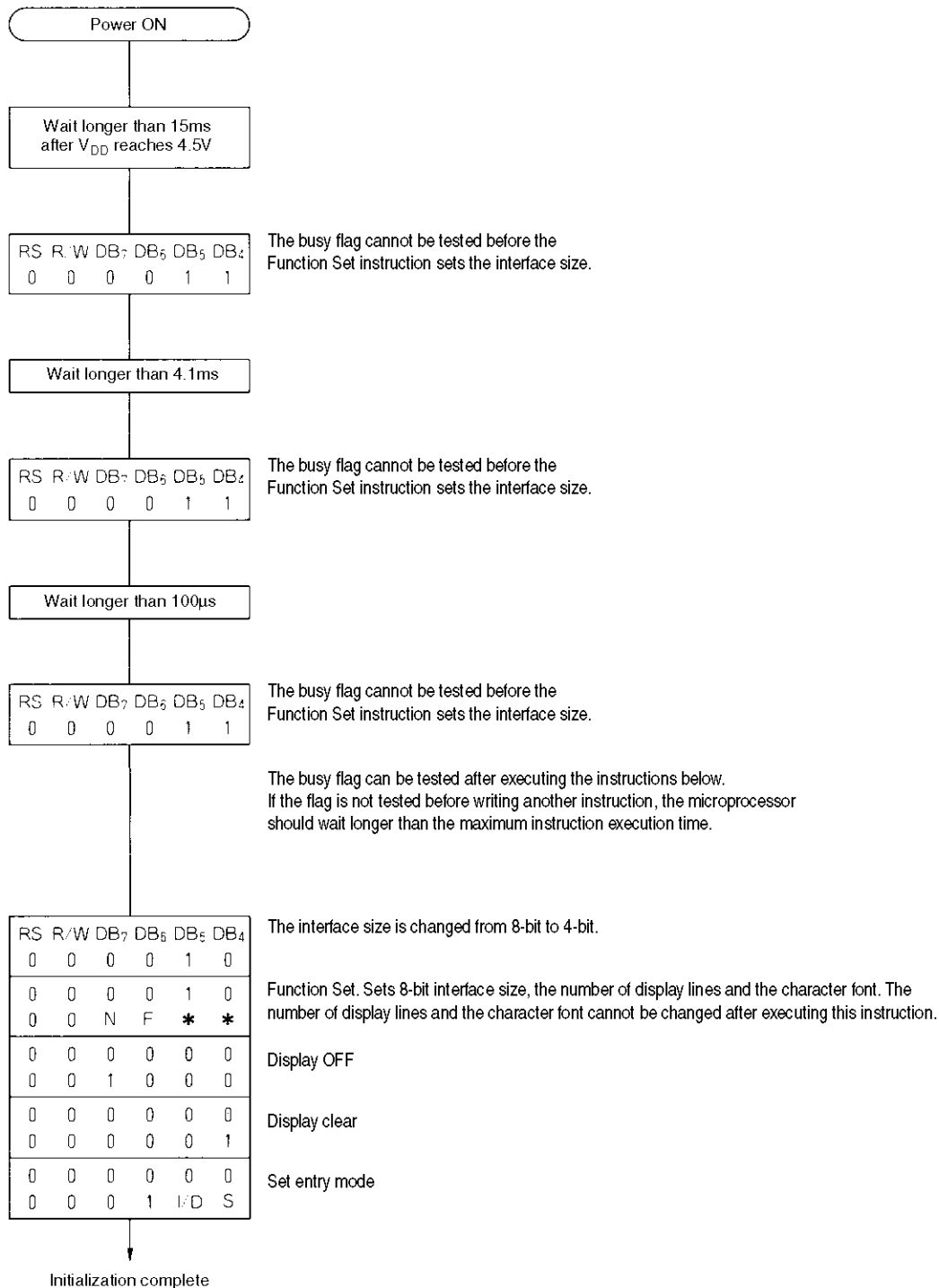

- No products described or contained herein are intended for use in surgical implants, life-support systems, aerospace equipment, nuclear power control systems, vehicles, disaster/crime-prevention equipment and the like, the failure of which may directly or indirectly cause injury, death or property loss.
- Anyone purchasing any products described or contained herein for an above-mentioned use shall:
 - ① Accept full responsibility and indemnify and defend SANYO ELECTRIC CO., LTD., its affiliates, subsidiaries and distributors and all their officers and employees, jointly and severally, against any and all claims and litigation and all damages, cost and expenses associated with such use:
 - ② Not impose any responsibility for any fault or negligence which may be cited in any such claim or litigation on SANYO ELECTRIC CO., LTD., its affiliates, subsidiaries and distributors or any of their officers and employees, jointly or severally.
- Information (including circuit diagrams and circuit parameters) herein is for example only; it is not guaranteed for volume production. SANYO believes information herein is accurate and reliable, but no guarantees are made or implied regarding its use or any infringements of intellectual property rights or other rights of third parties.

This catalog provides information as of July, 1997. Specifications and information herein are subject to change without notice.