



LA1828

Single-Chip Tuner IC for Portable Radio /Cassette Recorders with Manual Tuning

Functions

- AM: RF amplifier, mixer, oscillator, IF amplifier, detector, AGC, tuning display output
- FM-FE: RF amplifier, mixer, oscillator
- FM-IF: IF amplifier, quadrature detector, signal strength meter, tuning display output
- MPX: PLL stereo decoder, stereo display output, forced mono, internal VCO

Features

- Single-chip tuner with AM, FM-FE/FM-IF, MPX circuitry
- Built-in adjustment-free MPX-VCO (noceramic oscillator required)
- Reduced FM-FE oscillation level
- FM stereo indication and AM/FM tuning indication outputs can directly drive LEDs

Package Dimensions

unit:mm

3067-DIP24S

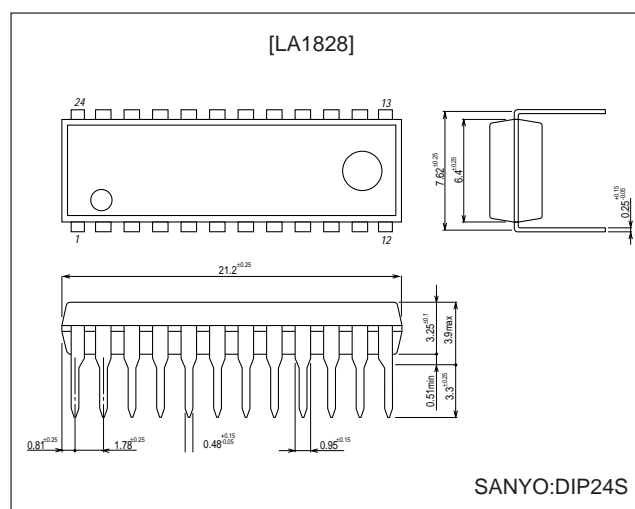

Specifications

Maximum Ratings at Ta = 25°C

Parameter	Symbol	Conditions	Ratings	Unit
Maximum supply voltage	V_{CCmax}		7.0	V
Indicator drive current	I_{LED}	pins 8, 9	20	mA
Allowable power dissipation	$Pd max$	$T_a \leq 70^\circ C$	300	mW
Operating temperature	T_{opr}		-20 to +70	°C
Storage temperature	T_{stg}		-40 to +125	°C

Operating Conditions at Ta = 25°C

Parameter	Symbol	Conditions	Ratings	Unit
Recommended supply voltage	V_{CC}		4.5	V
Operating supply voltage range	V_{CCOP}		2.5 to 6.0	V

LA1828

Operating Characteristics at $T_a = 25^\circ\text{C}$, $V_{cc} = 4.5\text{V}$, in specified test circuit, using Yamaichi Electronics socket IC-179-2

Parameter	Symbol	Conditions	Ratings			Unit
			min	typ	max	
[FM-FE characteristics]: $f_c = 98\text{ MHz}$, $f_m = 1\text{ kHz}$, 30% mod.						
Local oscillator voltage	V_{OSC}	$f_{OSC} = 108.7\text{ MHz}$, pin 20 output	40	80	160	mVrms
		*Measured with FET buffer (-10 dB gain)				
3 dB sensitivity	3dB LS	60 dB μ , 30% mod. output, -3 dB input		13		dB μ
Effective sensitivity	Qs	Input for S/N = 30 dB		12		dB μ
[FM-IF monaural characteristics]: $f_c = 10.7\text{ MHz}$, $f_m = 1\text{ kHz}$, 100% mod.						
Quiescent current	I_{CCO} (FM)	No input	8	16	23	mA
Demodulator output	V_O	100 dB μ , pin 16 output	130	190	260	mVrms
Signal-to-noise ratio	S/N	100 dB μ , pin 16 output	62	70		dB
Total harmonic distortion (mono)	THD	100 dB μ , pin 16 output		0.4	1.2	%
3 dB sensitivity	3 dB LS	100 dB μ , 100% mod. output, -3 dB input	21	32	42	dB μ
TU-LED sensitivity	SD-ON			33		dB μ
[FM-IF stereo characteristics]: $f_c = 10.7\text{ MHz}$, $f_m = 1\text{ kHz}$, L+R = 90%, pilot = 10%						
Separation	SEP	100 dB μ , L-mod, pin 16/pin 17 output	25	40		dB
ST-LED sensitivity	ST-ON	100 dB μ , pilot modulation for pin 8 voltage < 0.5V	1.5	3.5	6.3	%
Total harmonic distortion (main)	THD	100 dB μ , main modulation, pin 16 output		0.5	1.2	%
[AM characteristics]: $f_c = 1000\text{ kHz}$, $f_m = 1\text{ kHz}$, 30% mod.						
Quiescent current	I_{CCO} (AM)	No input	5	8.5	15	mA
Demodulator output	V_{O1}	23 dB μ , pin 16 output	18	40	70	mVrms
	V_{O2}	80 dB μ , pin 16 output	50	85	130	mVrms
Signal-to-noise ratio	S/N1	23 dB μ , pin 16 output	15	20		dB
	S/N2	80 dB μ , pin 16 output	47	53		dB
Total harmonic distortion	THD1	80 dB μ , pin 16 output		0.5	1.3	%
	THD2	107 dB μ , pin 16 output		0.5	1.5	%
TU-LED sensitivity	SD-ON			26		dB μ

Pin Description and Quiescent Voltage at $V_{cc} = 4.5\text{V}$

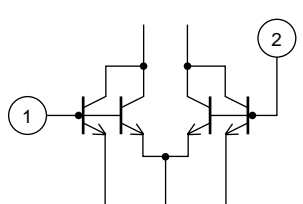
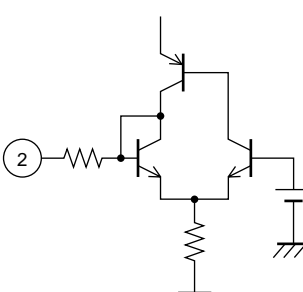
Pin number	Function	Quiescent voltage (V)		Equivalent circuit	Remarks
		AM	FM		
1	AM RF input	1.3	1.3	 <p style="text-align: center;">A10247</p>	AM antenna coil connected between pins 1 and 2 (reg)
2	Reg	1.3	1.3	 <p style="text-align: center;">A10248</p>	$V_{reg} = 1.3\text{V}$

Continued from preceding page

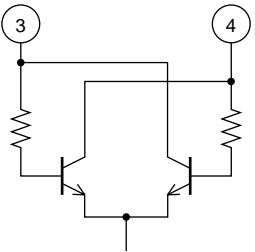
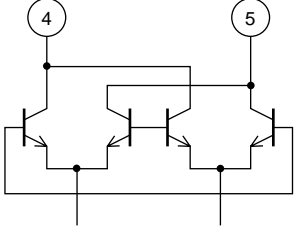
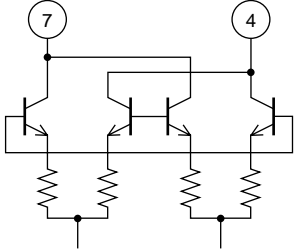
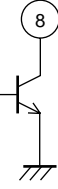
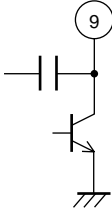
Pin number	Function	Quiescent voltage (V)		Equivalent circuit	Remarks
		AM	FM		
3	AM-OSC	4.5	4.5	 <p>A10249</p>	Oscillator coil connected between pins 3 and 4 (V_{CC1})
4	V_{CC1}	4.5	4.5		AM/FM-IN/MPX block V_{CC}
5	FM mixer output	4.5	4.5	 <p>A10250</p>	Mixer coil connected between pins 5 and 4 (V_{CC1})
6	GND1	0	0		AM/FM-IN/MPX section ground
7	AM mixer output	4.5	4.5	 <p>A10251</p>	Mixer coil connected between pins 7 and 4 (V_{CC1})
8	Tu-LED output	4.5	4.5	 <p>A10252</p>	Active low Open-collector output can directly drive LED (I_C max = 20 mA)
9	ST-LED output and AM-IF output	4.5	4.5	 <p>A10253</p>	Active low Open-collector output can directly drive LED (I_C max = 20 mA) In AM operation, AM-IF signal (450 kHz) is output here.

LA1828

Continued from preceding page

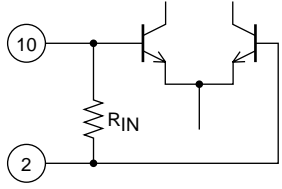
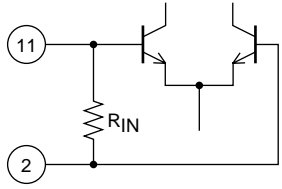
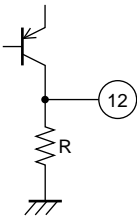
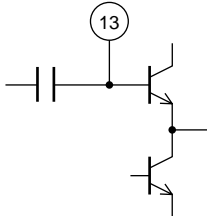
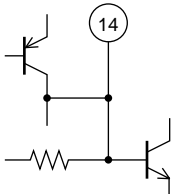
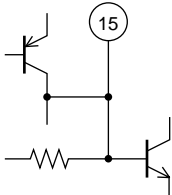
Pin number	Function	Quiescent voltage (V)		Equivalent circuit	Remarks
		AM	FM		
10	FM-IF input	1.3	1.3	 <p style="text-align: right;">A10254</p>	$R_{IN} = 330 \Omega$
11	AM-IF input	1.3	1.3	 <p style="text-align: right;">A10255</p>	$R_{IN} = 2 \text{ k}\Omega$
12	AM-AGC output and FM S meter output	0.7	0.2	 <p style="text-align: right;">A10256</p>	Internal load impedance $R = 16.6 \text{ k}\Omega$
13	FM detector	4.5	4.5	 <p style="text-align: right;">A10257</p>	Detector coil connected between pins 13 and 4 (V_{CC1})
14	Pilot tone detector filter and forced mono switching	2.9	3.8	 <p style="text-align: right;">A10258</p>	Mono mode is forced on by connecting pin 14 to ground.
15	Phase comparator filter and AM/FM switching	0	3.8	 <p style="text-align: right;">A10259</p>	FM reception mode is enabled when pin 15 is open. AM reception mode is enabled when pin 15 is connected to ground.

Continued on next page

LA1828

Continued from preceding page

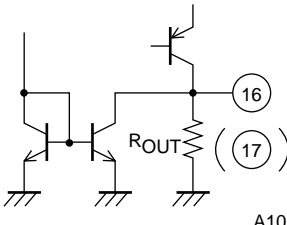
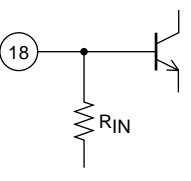
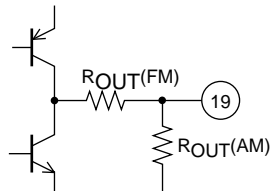
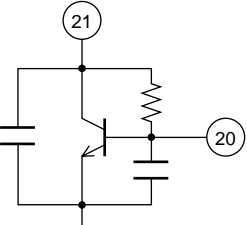
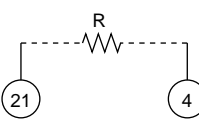
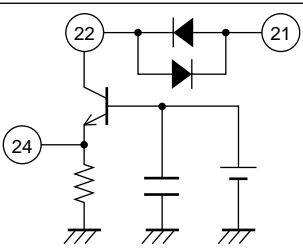
Pin number	Function	Quiescent voltage (V)		Equivalent circuit	Remarks
		AM	FM		
16 17	L output R output	1.4	1.4	 <p style="text-align: right;">A10260</p>	$R_{OUT} = 7.5 \text{ k}\Omega$
18	MPX input	1.3	1.3	 <p style="text-align: right;">A10261</p>	$R_{IN} = 50 \text{ k}\Omega$
19	FM detector output and AM detector output	0.5	1.5	 <p style="text-align: right;">A10262</p>	Output impedance AM: $R_{OUT} = 50 \text{ k}\Omega$ FM: $R_{OUT} = 500 \Omega$ Capacitance between pin 19 and ground should be optimized for the best separation characteristics.
20	FM-OSC	4.5	4.4	 <p style="text-align: right;">A10263</p>	Colpitts oscillator circuit FM oscillator coil connected to pin 20.
21	V_{CC2}	4.5	4.4	 <p style="text-align: right;">A10264</p>	FM-FE block V_{CC} Power is supplied from pin 4 (V_{CC1}) via external resistor (10Ω).
22 24	FM-RF output FM-RF input	4.5 0	4.4 1.0	 <p style="text-align: right;">A10265</p>	FM RF coil connected between pins 22 and 21 (V_{CC2}). $R_{IN} = 1.8 \text{ k}\Omega$
23	GND2	0	0		FM-FE block ground

Coil specifications (bottom view)

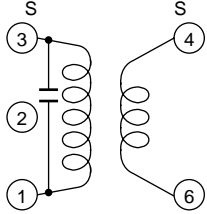
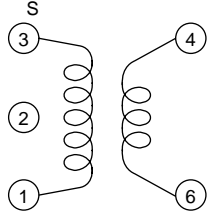
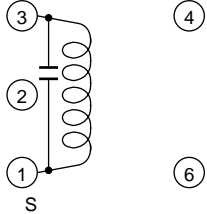
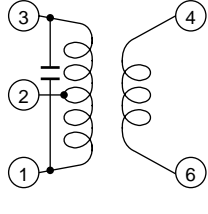
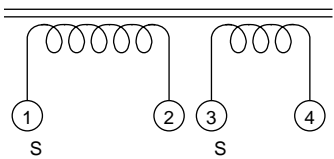
<p>• FM-BPF: SA-309 (Sumida) 88 to 108 MHz</p>	
<p>• FM-RF: SA-149 (Sumida) 3.6 mm dia., air core, 0.6 mm wire, 4 1/2 T</p>	
<p>• FM-OSC: SA-151 (Sumida) 3.6 mm dia., air core, 0.6 mm wire, 3 1/2 T</p>	
<p>• FM-Mix: SA-165 (Sumida)</p>  <p>④ - ⑥ 2T ③ - ① 12T 0.12 UEW $f_0 = 10.7$ MHz $Q_0 \geq 50$ With 100 pF internal capacitor</p> <p>A10395</p>	<p>• AM-OSC: SA-181 (Sumida)</p>  <p>⑥ - ④ 37T ③ - ① 74T 0.06 UEW $f_0 = 796$ kHz $Q_0 \geq 80$ $L = 140$ μH</p> <p>A10269</p>
<p>• FM-Det: SA-1134 (Sumida)</p>  <p>① - ③ 12T 0.10 UEW $f_0 = 10.7$ MHz $Q_0 \geq 70$ With 82 pF internal capacitor</p> <p>A10267</p>	<p>• AM-IFT: SA-1136 (Sumida)</p>  <p>③ - ② 122T ④ - ⑥ 9T ② - ① 62T 0.06 UEW $f_0 = 450$ kHz $Q_0 \geq 65$ With 180 pF internal capacitor</p> <p>A10270</p>
<p>• FM-IF filter: SFE10.7MS2 (Murata)</p>	<p>• AM-IF filter: SFU450B (Murata)</p>
<p>• Poly-varicon: FT-2217 (Toko) or PVC-22KTL (Mitsumi)</p>	
<p>• MW bar antenna: TYA-1005 (Mitsumi)</p>  <p>① - ② 68T ③ - ④ 9T $f_0 = 796$ kHz $Q_0 \geq 230$ $L = 260$ μH</p> <p>A10394</p>	

• FM-Mix: YT-30224 (Mitsumi) for DUT

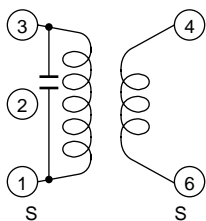

A10266

⑥ - ④ 2T
 ① - ③ 8T
 0.12 UEW
 $f_0 = 10.7 \text{ MHz}$
 $Q_0 = 80$
 With 150 pF
 internal capacitor

• AM-OSC: HW-50425 (Mitsumi) for DUT

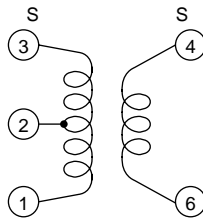

A10271

③ - ② 2T
 ④ - ⑥ 9T
 ② - ① 86T
 $Q_0 \geq 80$
 $L = 270 \mu\text{H}$

• FM-Det: YT-30103 (Mitsumi) for DUT

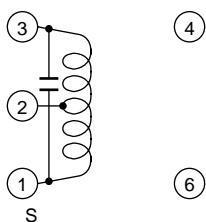

A10268

① - ③ 10T
 $f_0 = 10.7 \text{ MHz}$
 $Q_0 = 90$
 With 82 pF
 internal capacitor

• AM-IFT: YD-1073-1 (Mitsumi) for DUT

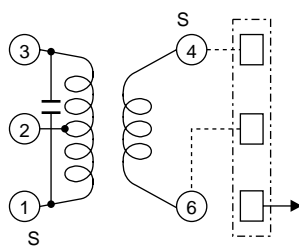

A10272

① - ② 58T
 ④ - ⑥ 7T
 ② - ③ 94T
 $f_0 = 450 \text{ kHz}$
 With 180 pF
 internal capacitor

Block Diagram

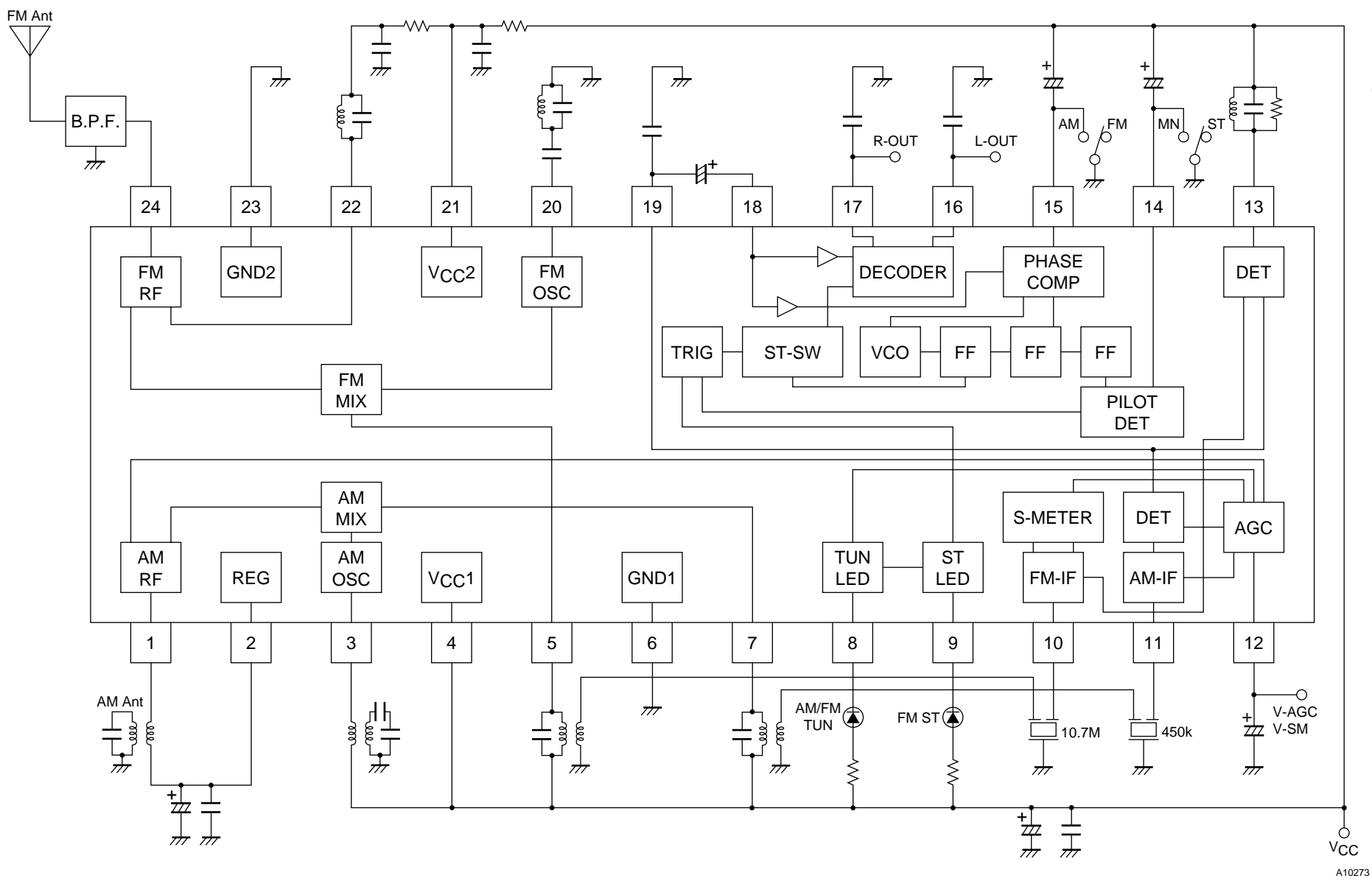

Test Circuit

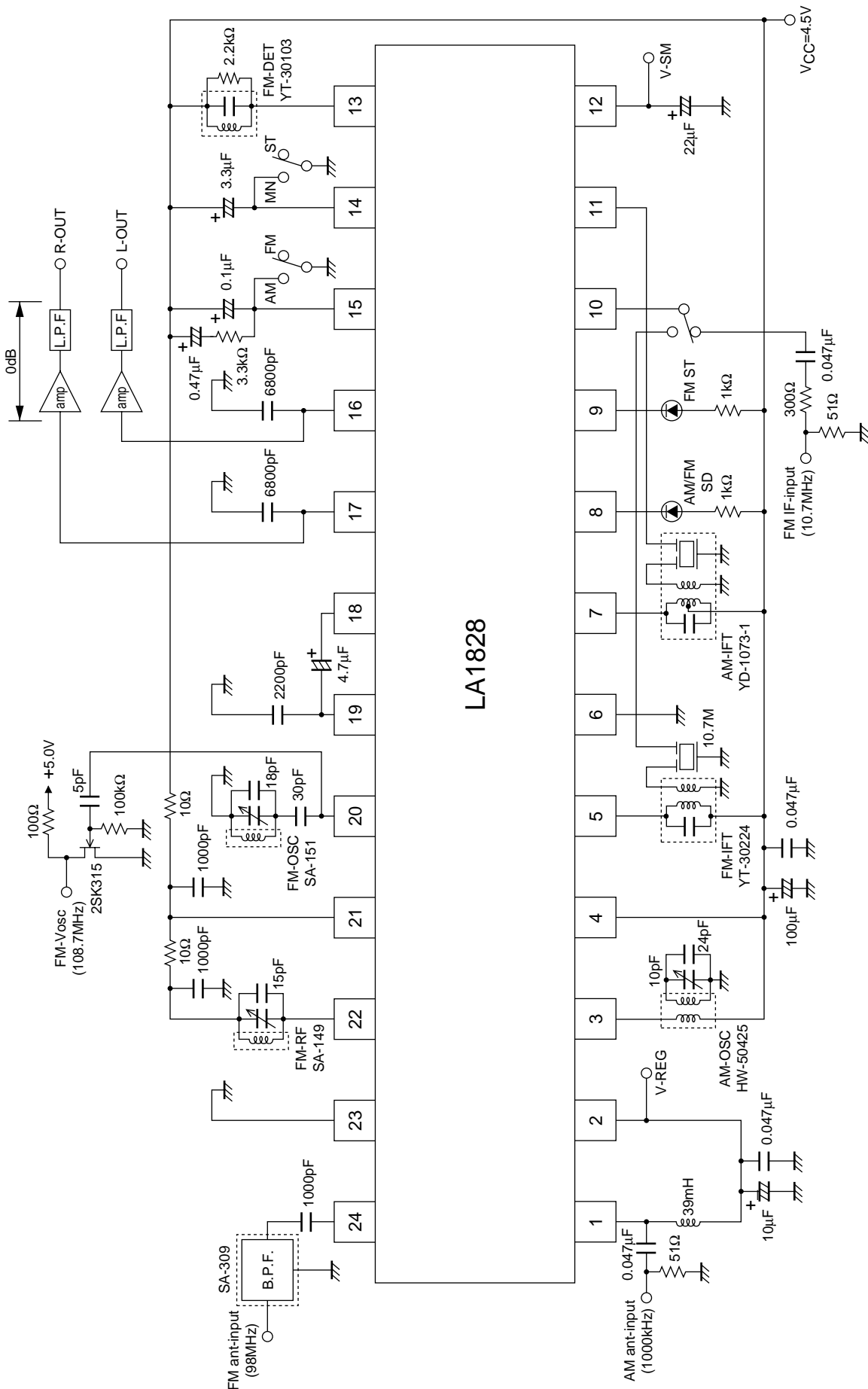

A10274

Sample Application Circuit

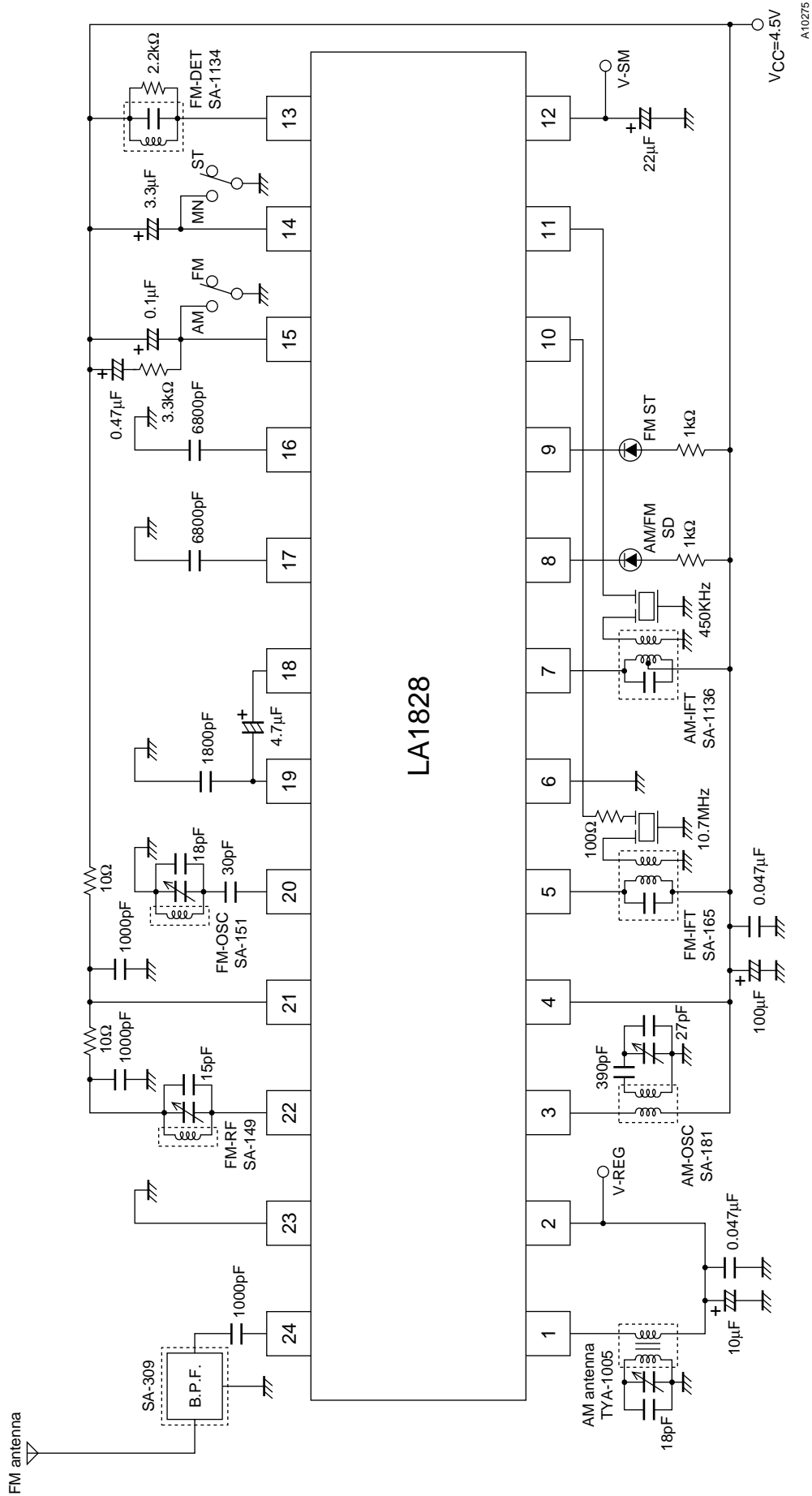

A10275

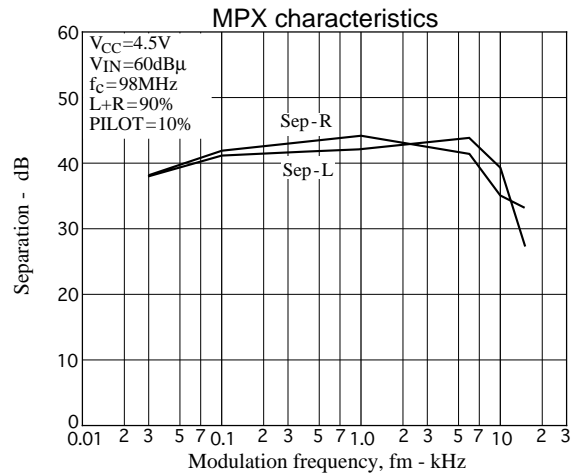
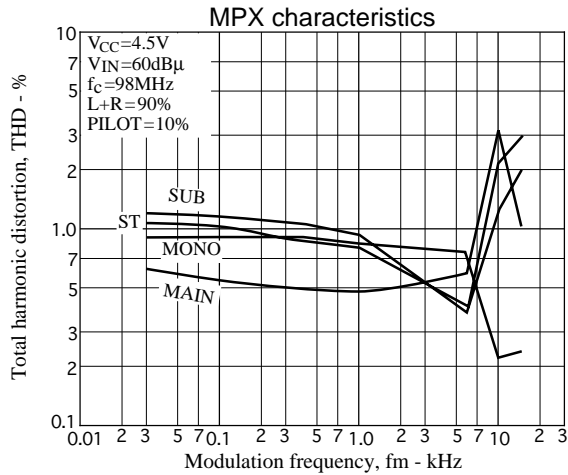
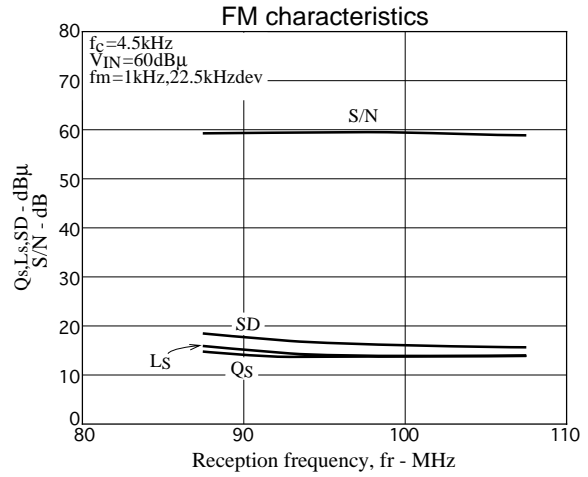
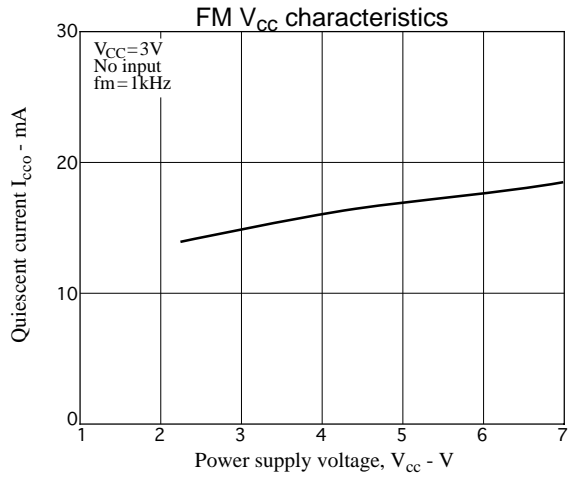
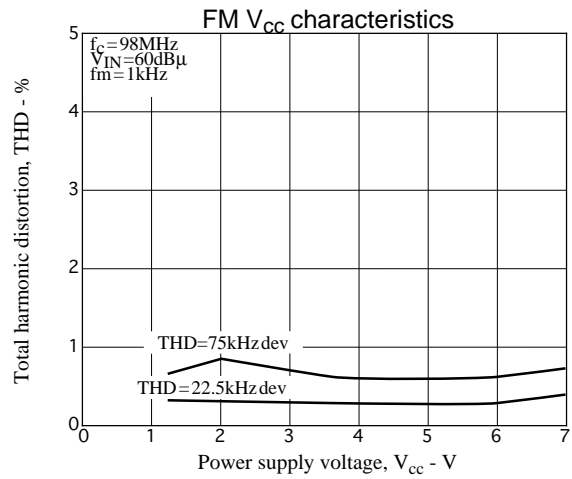
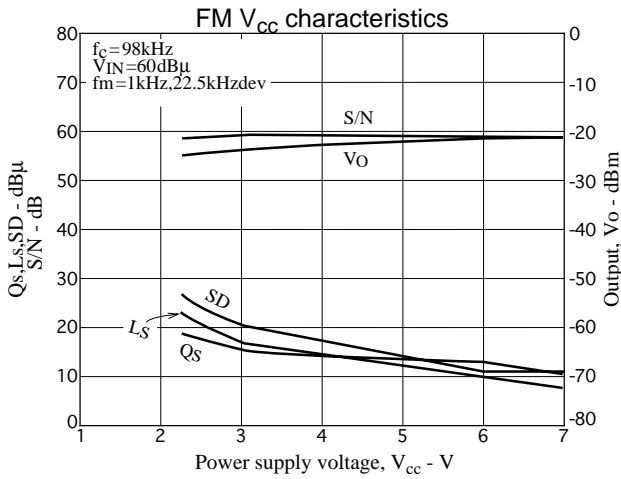
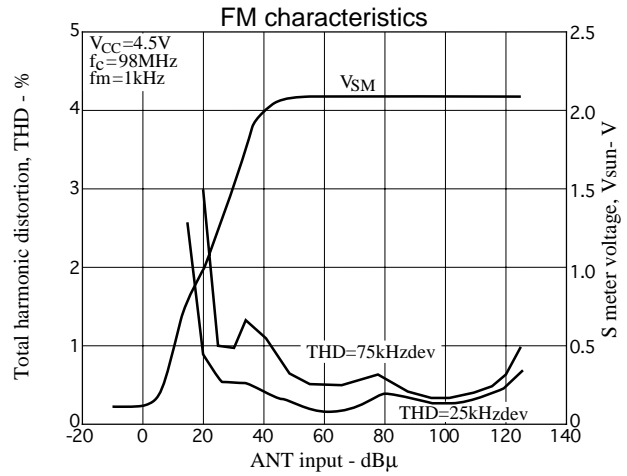
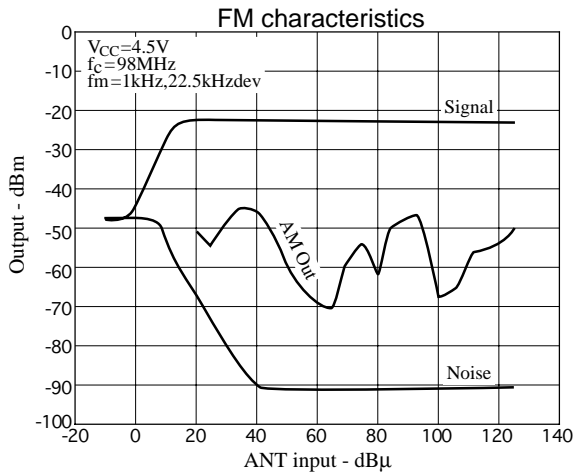

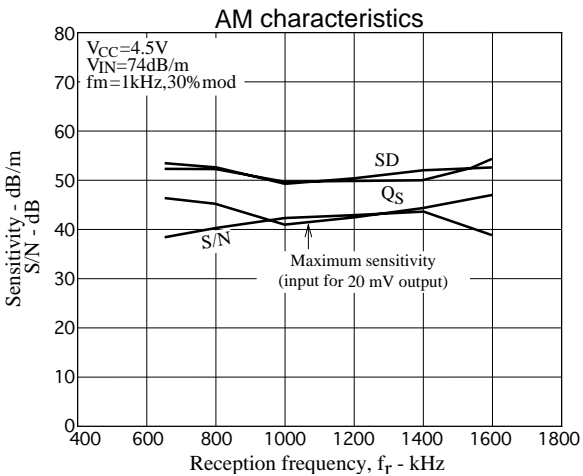
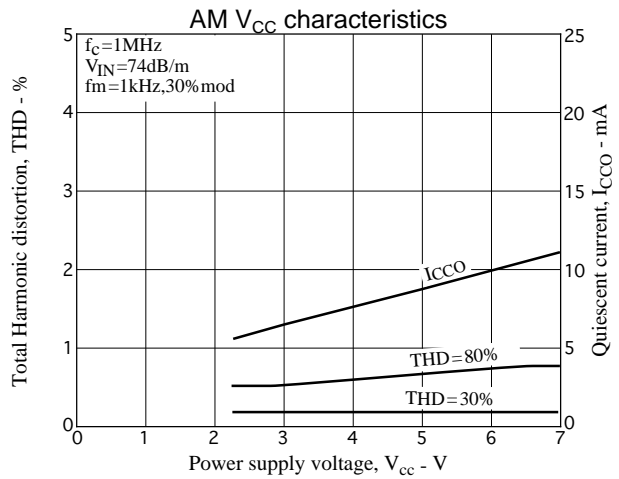
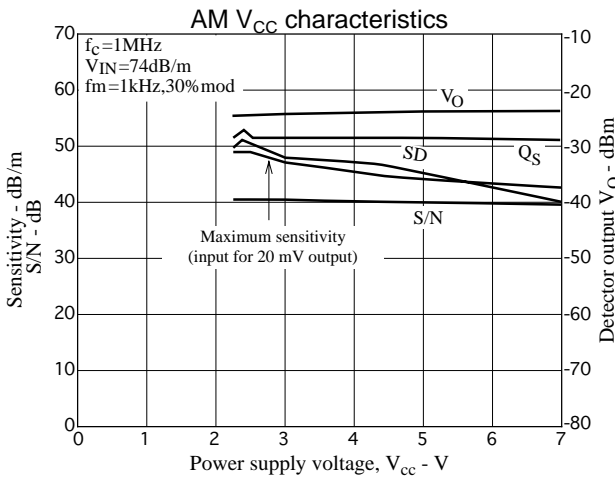
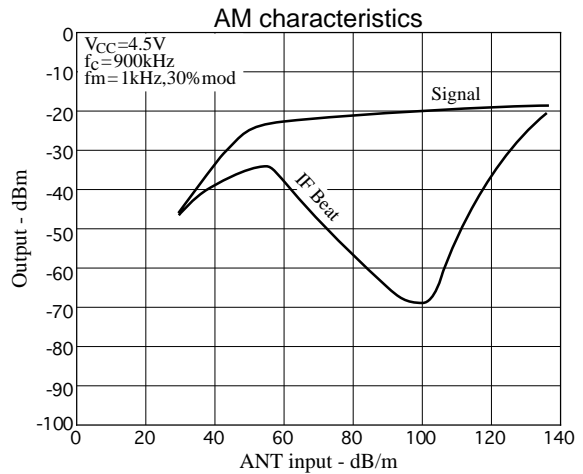
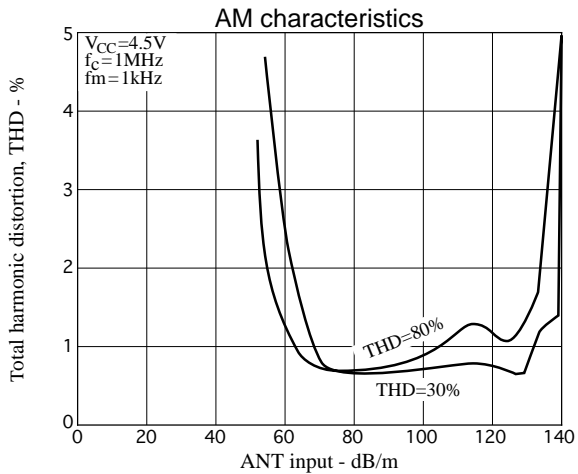
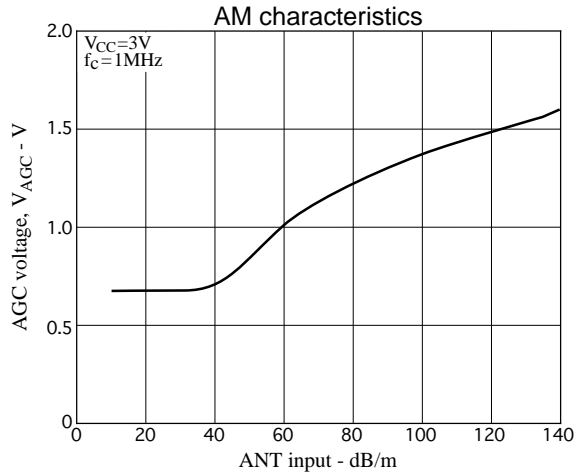
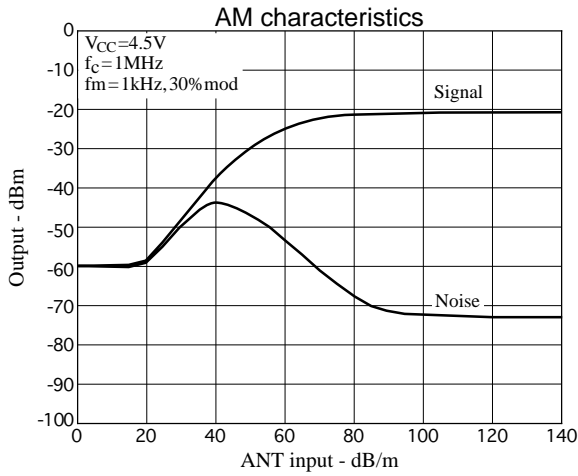

- No products described or contained herein are intended for use in surgical implants, life-support systems, aerospace equipment, nuclear power control systems, vehicles, disaster/crime-prevention equipment and the like, the failure of which may directly or indirectly cause injury, death or property loss.
- Anyone purchasing any products described or contained herein for an above-mentioned use shall:
 - ① Accept full responsibility and indemnify and defend SANYO ELECTRIC CO., LTD., its affiliates, subsidiaries and distributors and all their officers and employees, jointly and severally, against any and all claims and litigation and all damages, cost and expenses associated with such use:
 - ② Not impose any responsibility for any fault or negligence which may be cited in any such claim or litigation on SANYO ELECTRIC CO., LTD., its affiliates, subsidiaries and distributors or any of their officers and employees jointly or severally.
- Information (including circuit diagrams and circuit parameters) herein is for example only; it is not guaranteed for volume production. SANYO believes information herein is accurate and reliable, but no guarantees are made or implied regarding its use or any infringements of intellectual property rights or other rights of third parties.

This catalog provides information as of May, 1998. Specifications and information herein are subject to change without notice.