



# FP102

PNP Epitaxial Planar Silicon Transistor/  
Composite Schottky Barrier Diode

## DC-DC Converter Applications

### Features

- Composite type with a PNP transistor and a Schottky barrier diode contained in one package, facilitating high-density mounting.
- The FP102 is formed with 2chips, one being equivalent to the 2SB1396 and the other the SB07-03C, placed in one package.

### Package Dimensions

unit:mm  
2088A

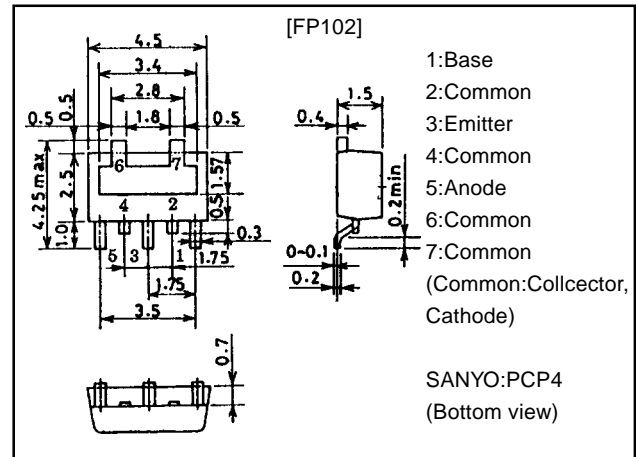

### Specifications

#### Absolute Maximum Ratings at Ta = 25°C

Parameter	Symbol	Conditions	Ratings	Unit
[TR]				
Collector-to-Base Voltage	$V_{CB0}$		-15	V
Collector-to-Emitter Voltage	$V_{CE0}$		-11	V
Emitter-to-Base Voltage	$V_{EB0}$		-7	V
Collector Current	$I_C$		-3	A
Collector Current (Pulse)	$I_{CP}$		-5	A
Base Current	$I_B$		-600	mA
Collector Dissipation	$P_C$	Mounted on ceramic board (250mm <sup>2</sup> ×0.8mm)	1.3	W
Junction Temperature	$T_J$		150	°C
[SBD]				
Repetitive Peak Reverse Voltage	$V_{RRM}$		30	V
Non-repetitive Peak Reverse Surge Voltage	$V_{RSM}$		35	V
Average Rectified Current	$I_O$		700	mA
Surge Forward Current	$I_{FSM}$	50Hz sine wave, 1cycle	5	A
Junction Temperature	$T_J$		-55 to +125	°C
Storage Temperature	$T_{stg}$		-55 to +125	°C

Marking: 102

Continued on next page.

### Electrical Connection

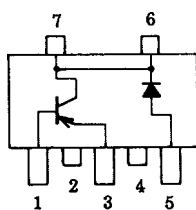

- 1:Base  
2:Common  
3:Emitter  
4:Common  
5:Anode  
6:Common  
7:Common  
(Common:Collector, Cathode)  
(Top view)

# FP102

Continued from preceding page.

## Electrical Characteristics at Ta=25°C

Parameter	Symbol	Conditions	Ratings			Unit
			min	typ	max	
[TR]						
Collector Cutoff Current	$I_{CBO}$	$V_{CB}=-12V, I_E=0$			-0.1	$\mu A$
Emitter Cutoff Current	$I_{EBO}$	$V_{EB}=-6V, I_C=0$			-0.1	$\mu A$
DC Current Gain	$h_{FE1}$	$V_{CE}=-2V, I_C=-0.5A$	140		560	
	$h_{FE2}$	$V_{CE}=-2V, I_C=-3A$	70			
Gain-Bandwidth Product	$f_T$	$V_{CE}=-2V, I_C=-0.3A$		400		MHz
Output Capacitance	$C_{ob}$	$V_{CB}=-10V, f=1MHz$		26		pF
C-E Saturation Voltage	$V_{CE(sat)}$	$I_C=-1.5A, I_B=-30mA$		-0.22	-0.4	V
B-E Saturation Voltage	$V_{BE(sat)}$	$I_C=-1.5A, I_B=-30mA$		-0.9	-1.2	V
C-B Breakdown Voltage	$V_{(BR)CBO}$	$I_C=-10\mu A, I_E=0$	-15			V
C-E Breakdown Voltage	$V_{(BR)CEO}$	$I_C=-1mA, R_{BE}=\infty$	-11			V
E-B Breakdown Voltage	$V_{(BR)EBO}$	$I_E=-10\mu A, I_C=0$	-7			V
Turn-ON Time	$t_{on}$	See specified Test Circuit		25		ns
Storage Time	$t_{stg}$	See specified Test Circuit		200		ns
Fall Time	$t_f$	See specified Test Circuit		10		ns
[SBD]						
Reverse Voltage	$V_R$	$I_R=300\mu A$	30			V
Forward Voltage	$V_F$	$I_F=700mA$			0.55	V
Reverse Current	$I_R$	$V_R=15V$			80	$\mu A$
Interterminal Capacitance	$C$	$V_R=10V, f=1MHz$		28		pF
Reverse Recovery Time	$t_{rr}$	$I_F=I_R=100mA$ , See specified Test Circuit			10	ns
Thermal Resistance	$R_{thj-a}$	Mounted on ceramic board (250mm <sup>2</sup> ×0.8mm)		120		°C/W

## Switching Time Test Circuit

(TR)

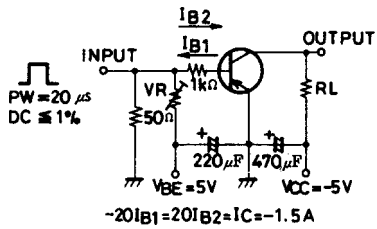

(SBD)

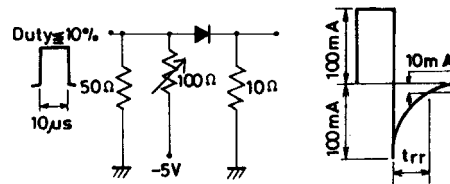

# FP102

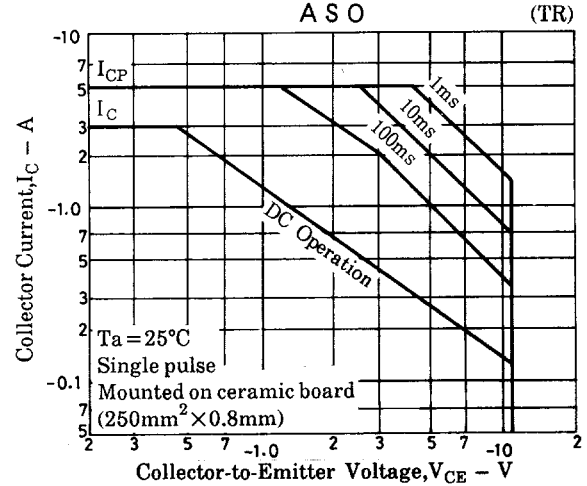
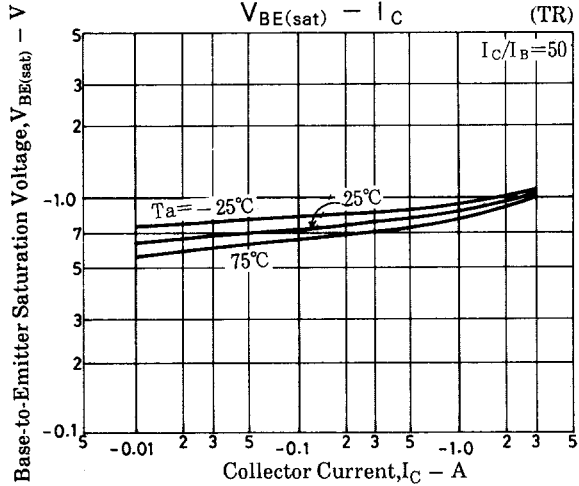
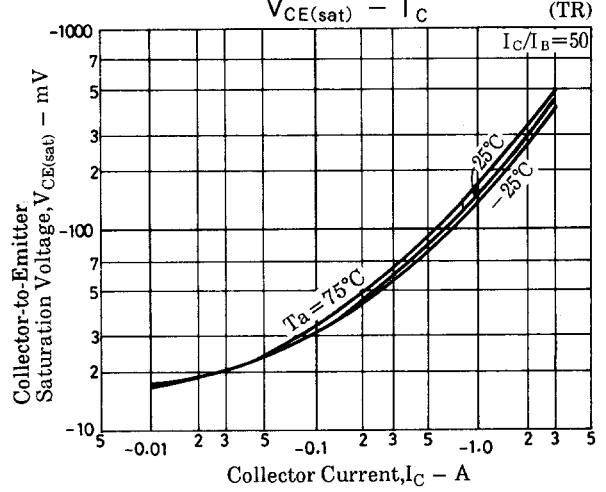
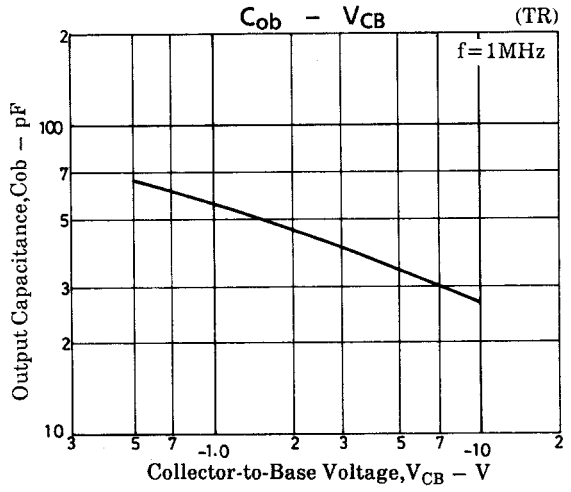
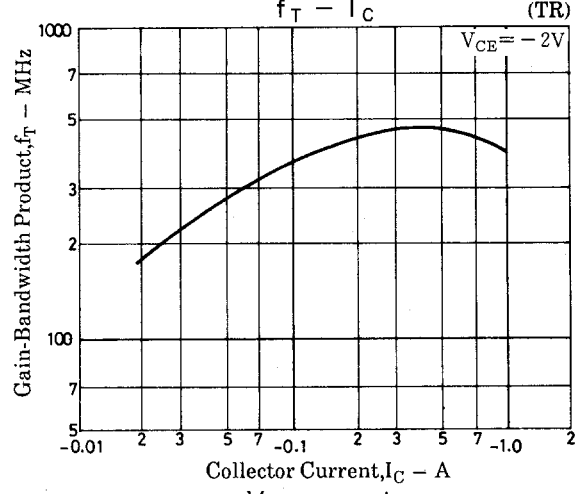
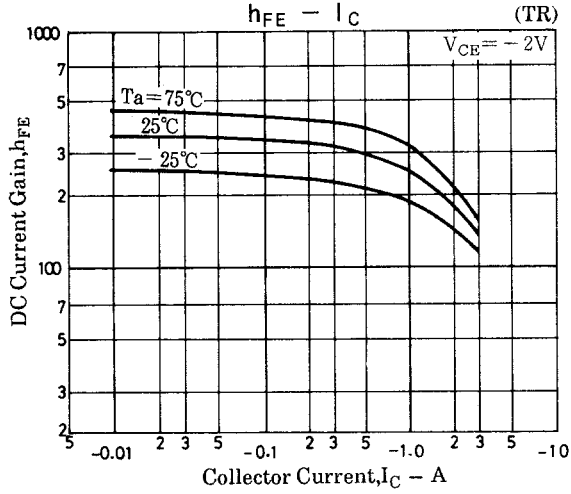
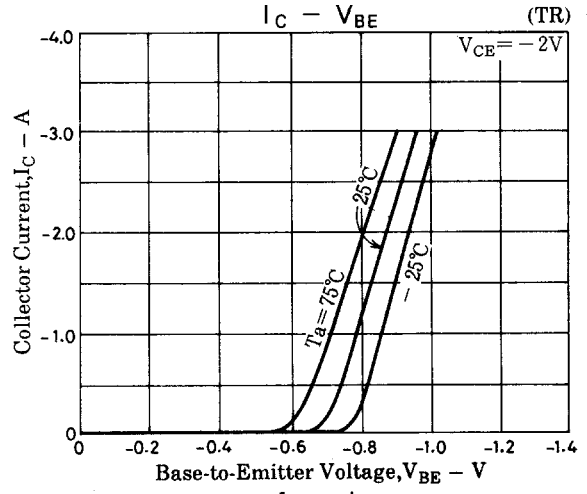
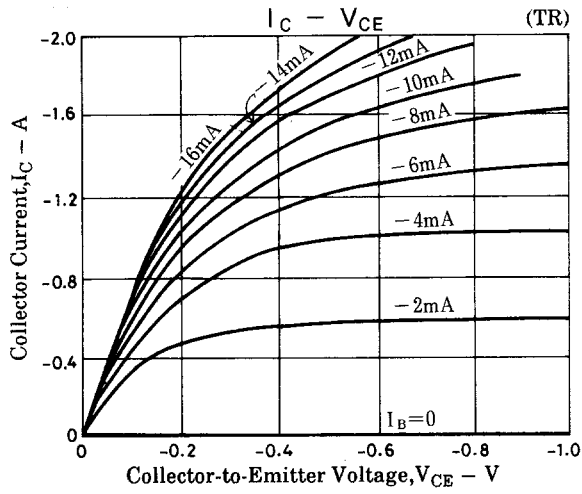

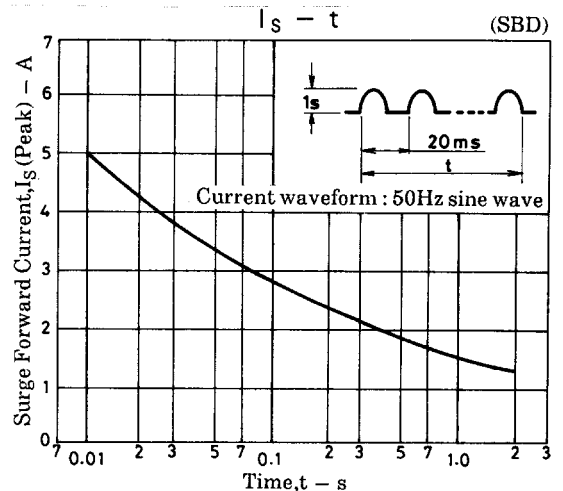
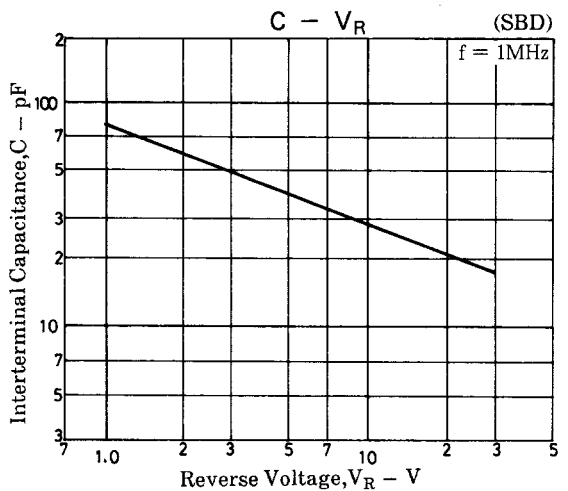
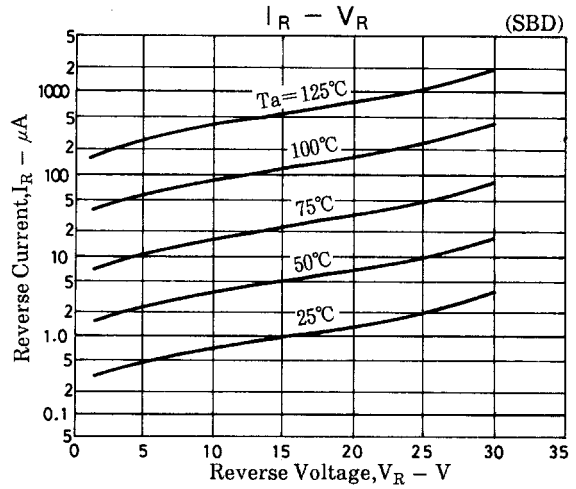
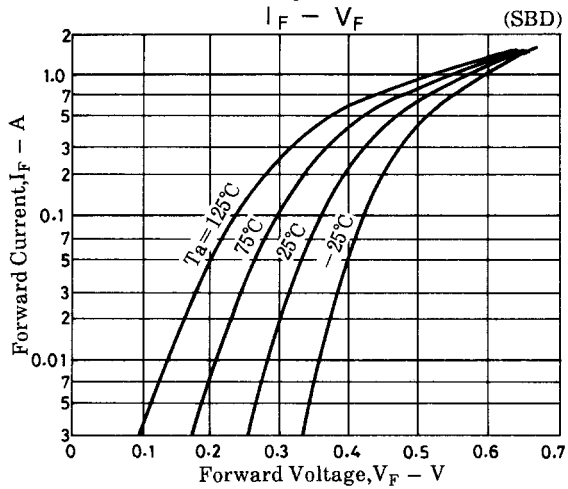
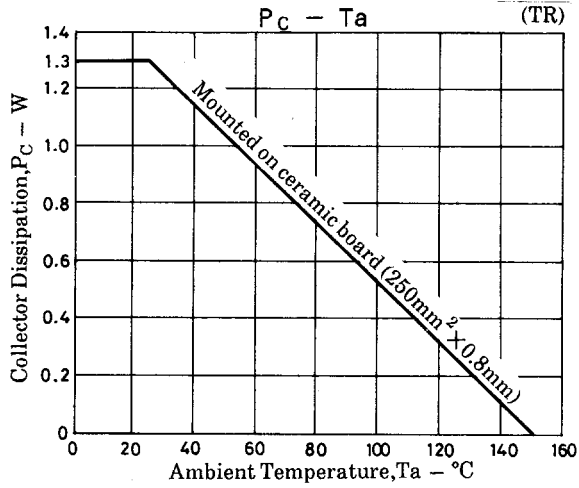

■ No products described or contained herein are intended for use in surgical implants, life-support systems, aerospace equipment, nuclear power control systems, vehicles, disaster/crime-prevention equipment and the like, the failure of which may directly or indirectly cause injury, death or property loss.

■ Anyone purchasing any products described or contained herein for an above-mentioned use shall:

- ① Accept full responsibility and indemnify and defend SANYO ELECTRIC CO., LTD., its affiliates, subsidiaries and distributors and all their officers and employees, jointly and severally, against any and all claims and litigation and all damages, cost and expenses associated with such use:
- ② Not impose any responsibility for any fault or negligence which may be cited in any such claim or litigation on SANYO ELECTRIC CO., LTD., its affiliates, subsidiaries and distributors or any of their officers and employees jointly or severally.

■ Information (including circuit diagrams and circuit parameters) herein is for example only; it is not guaranteed for volume production. SANYO believes information herein is accurate and reliable, but no guarantees are made or implied regarding its use or any infringements of intellectual property rights or other rights of third parties.

This catalog provides information as of May, 1998. Specifications and information herein are subject to change without notice.