



Ultrahigh-Speed Switching Applications

Features

- Low ON resistance.
- 2.5V drive.

Package Dimensions

unit:mm

2129

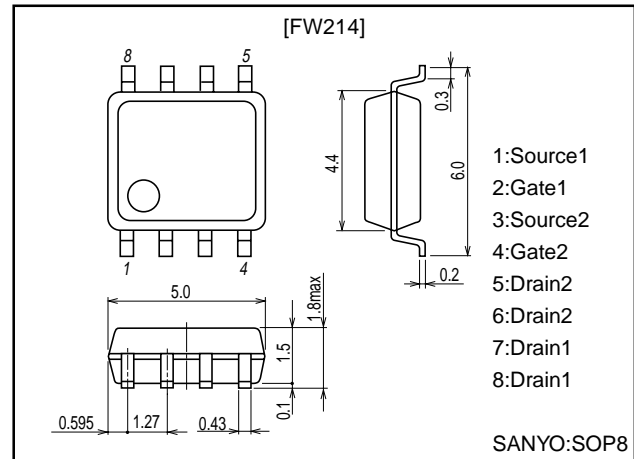

Specifications

Absolute Maximum Ratings at Ta = 25°C

Parameter	Symbol	Conditions	Ratings	Unit
Drain-to-Source Voltage	V_{DSS}		20	V
Gate-to-Source Voltage	V_{GSS}		± 10	V
Drain Current (DC)	I_D		5	A
Drain Current (pulse)	I_{DP}	$PW \leq 10\mu s$, duty cycle $\leq 1\%$	48	A
Allowable Power Dissipation	P_D	Mounted on ceramic board (1200mm ² ×0.8mm) 1unit	1.7	W
Total Dissipation	P_T	Mounted on ceramic board (1200mm ² ×0.8mm)	2.0	W
Channel Temperature	T_{ch}		150	°C
Storage Temperature	T_{stg}		-55 to +150	°C

Electrical Characteristics at Ta = 25°C

Parameter	Symbol	Conditions	Ratings			Unit
			min	typ	max	
D-S Breakdown Voltage	$V_{(BR)DSS}$	$I_D=1mA$, $V_{GS}=0$	20			V
Zero Gate Voltage Drain Current	I_{DSS}	$V_{DS}=20V$, $V_{GS}=0$			100	μA
Gate-to-Source Leak Current	I_{GSS}	$V_{GS}=\pm 8V$, $V_{DS}=0$			± 10	μA
Cutoff Current	$V_{GS(off)}$	$V_{DS}=10V$, $I_D=1mA$	0.4		1.3	V
Forward Transfer Admittance	$ y_{fs} $	$V_{DS}=10V$, $I_D=5A$	8	13		S
Static Drain-to-Source ON-State Resistance	$R_{DS(on)1}$	$I_D=5A$, $V_{GS}=4V$		38	50	m Ω
	$R_{DS(on)2}$	$I_D=2A$, $V_{GS}=2.5V$		50	70	m Ω
Input Capacitance	C_{iss}	$V_{DS}=10V$, $f=1MHz$		500		pF
Output Capacitance	C_{oss}	$V_{DS}=10V$, $f=1MHz$		280		pF
Reverse Transfer Capacitance	C_{rss}	$V_{DS}=10V$, $f=1MHz$		150		pF
Turn-ON Delay Time	$t_{d(on)}$	See specified Test Circuit		20		ns
Rise Time	t_r	See specified Test Circuit		250		ns
Turn-OFF Delay Time	$t_{d(off)}$	See specified Test Circuit		70		ns
Fall Time	t_f	See specified Test Circuit		130		ns
Total Gate Charge	Q_g	$V_{DS}=10V$, $V_{GS}=10V$, $I_D=5A$		22		nC
Gate-to-Source Charge	Q_{gs}	$V_{DS}=10V$, $V_{GS}=10V$, $I_D=5A$		3		nC
Gate-to-Drain ("Miller") Charge	Q_{gd}	$V_{DS}=10V$, $V_{GS}=10V$, $I_D=5A$		3		nC
Diode Forward Voltage	V_{SD}	$I_S=5A$, $V_{GS}=0$	1.0	1.2		V

Switching Time Test Circuit

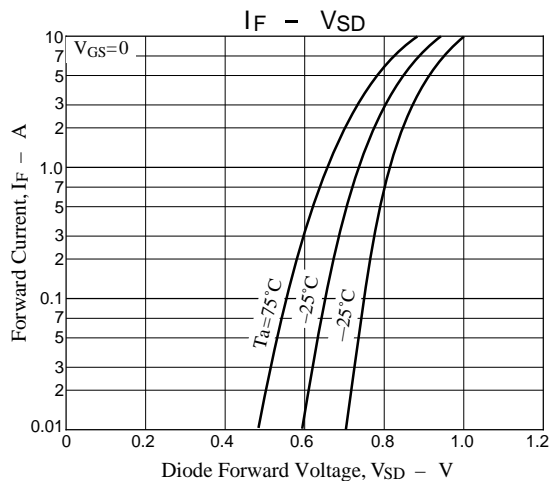
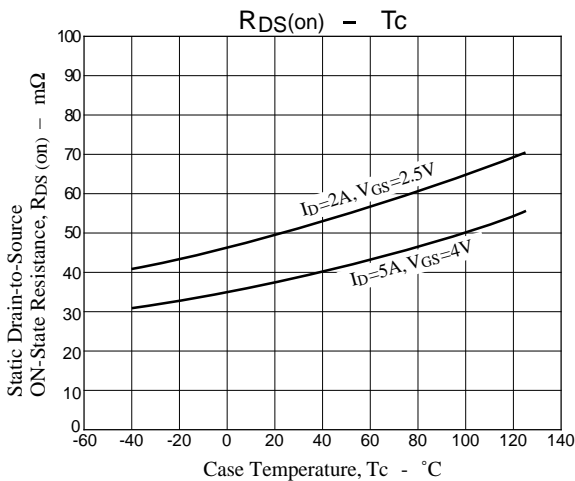
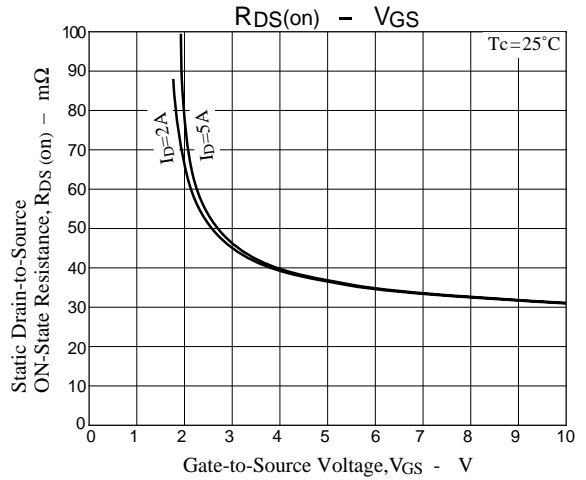
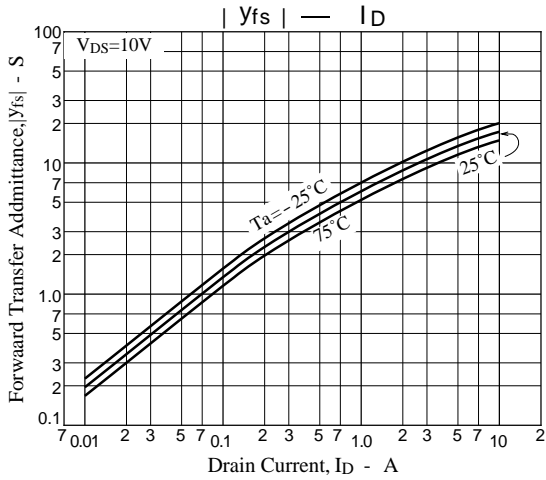
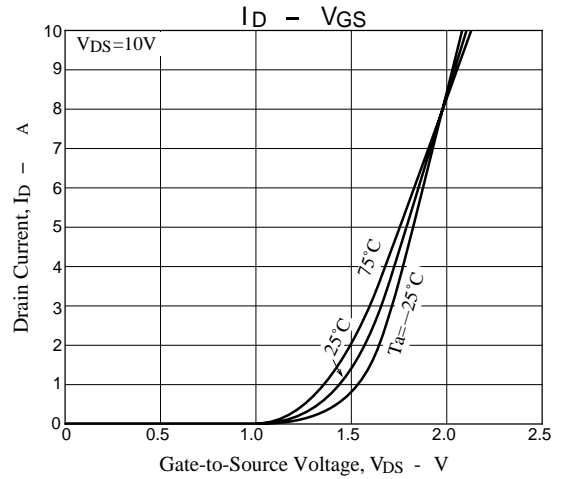
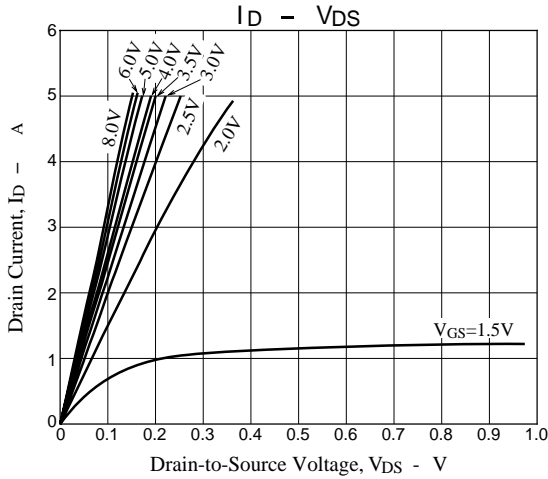
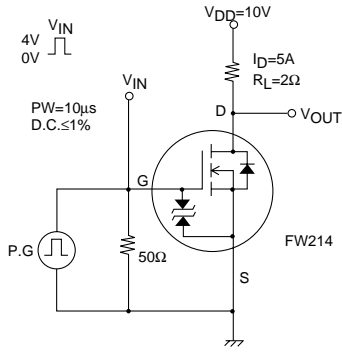

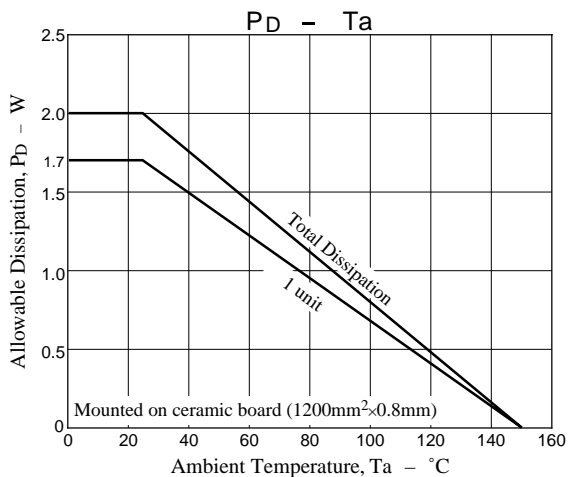
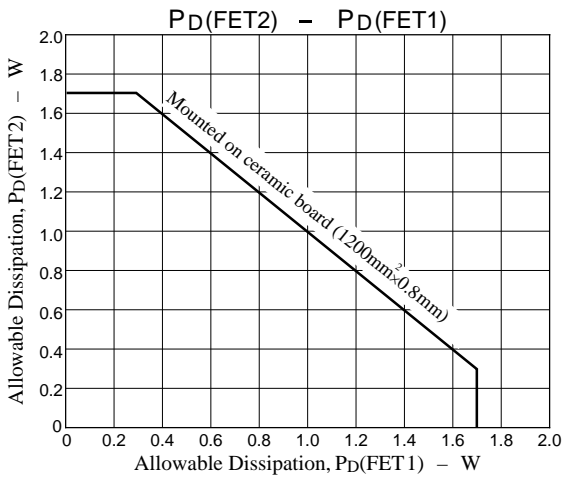
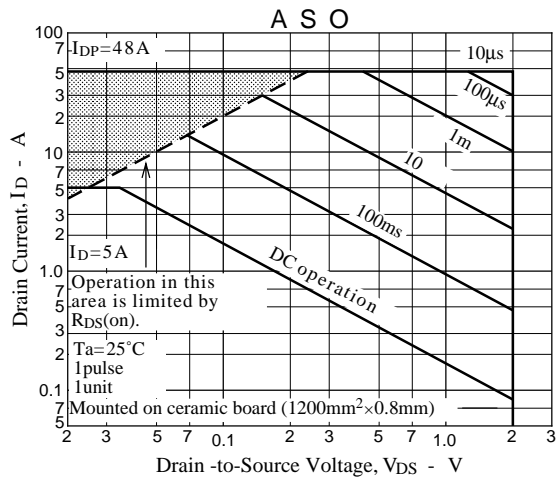
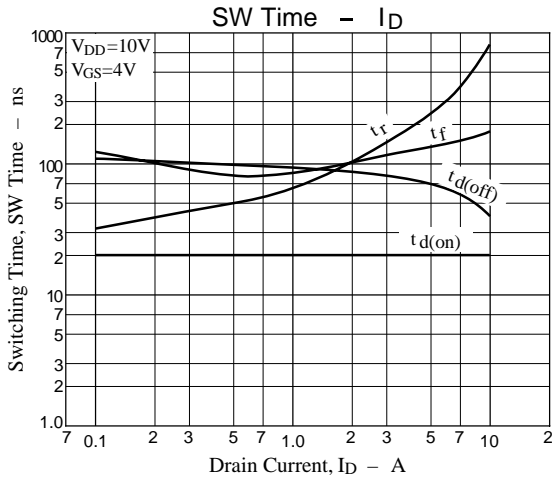
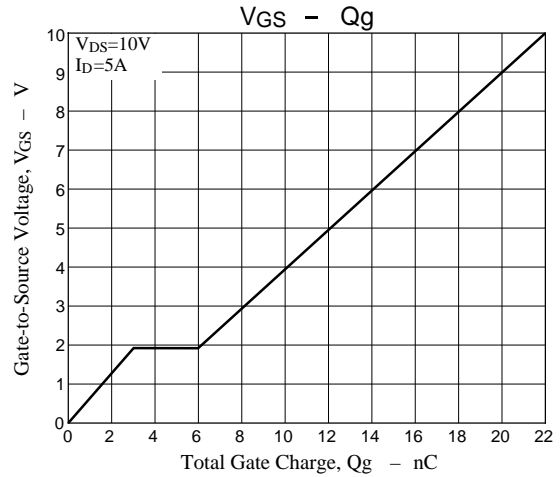
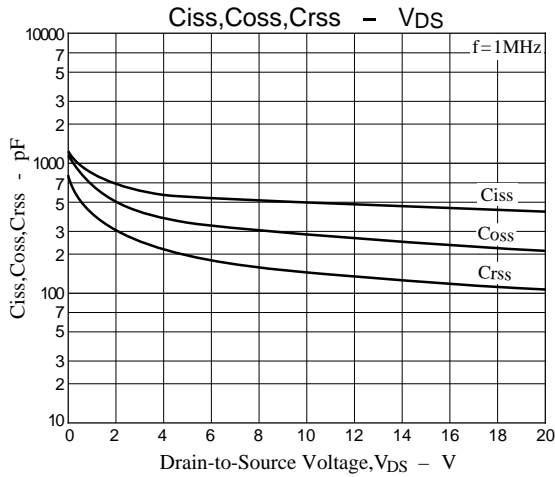

■ No products described or contained herein are intended for use in surgical implants, life-support systems, aerospace equipment, nuclear power control systems, vehicles, disaster/crime-prevention equipment and the like, the failure of which may directly or indirectly cause injury, death or property loss.

■ Anyone purchasing any products described or contained herein for an above-mentioned use shall:

- ① Accept full responsibility and indemnify and defend SANYO ELECTRIC CO., LTD., its affiliates, subsidiaries and distributors and all their officers and employees, jointly and severally, against any and all claims and litigation and all damages, cost and expenses associated with such use:
- ② Not impose any responsibility for any fault or negligence which may be cited in any such claim or litigation on SANYO ELECTRIC CO., LTD., its affiliates, subsidiaries and distributors or any of their officers and employees jointly or severally.

■ Information (including circuit diagrams and circuit parameters) herein is for example only; it is not guaranteed for volume production. SANYO believes information herein is accurate and reliable, but no guarantees are made or implied regarding its use or any infringements of intellectual property rights or other rights of third parties.

This catalog provides information as of May, 1998. Specifications and information herein are subject to change without notice.