



## 2SA1415/2SC3645

### High-Voltage Switching, Predriver Applications

#### Features

- Adoption of FBET process.
- High breakdown voltage ( $V_{CEO}=160V$ ).
- Excellent linearity of  $h_{FE}$  and small  $C_{ob}$ .
- Fast switching speed.
- Very small size marking it easy to provide high-density, small-sized hybrid ICs.

#### Package Dimensions

unit:mm

2038

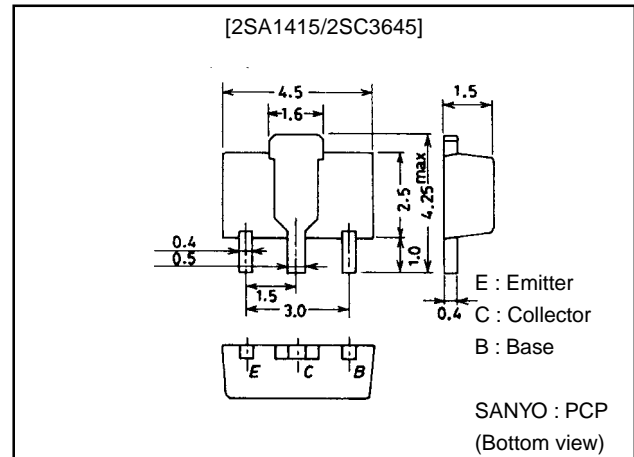

() : 2SA1415

#### Specifications

##### Absolute Maximum Ratings at $T_a = 25^\circ C$

Parameter	Symbol	Conditions	Ratings	Unit
Collector-to-Base Voltage	$V_{CBO}$		(-)180	V
Collector-to-Emitter Voltage	$V_{CEO}$		(-)160	V
Emitter-to-Base Voltage	$V_{EBO}$		(-)5	V
Collector Current	$I_C$		(-)140	mA
Collector Current (Pulse)	$I_{CP}$		(-)200	mA
Collector Dissipation	$PC1$		500	mW
	$PC2$	Mounted on ceramic board (250mm <sup>2</sup> ×0.8mm)	1.3	W
Junction Temperature	$T_j$		150	$^\circ C$
Storage Temperature	$T_{stg}$		-55 to +150	$^\circ C$

##### Electrical Characteristics at $T_a = 25^\circ C$

Parameter	Symbol	Conditions	Ratings			Unit
			min	typ	max	
Collector Cutoff Current	$I_{CBO}$	$V_{CB}=(-)80V, I_E=0$			(-)100	nA
Emitter Cutoff Current	$I_{EBO}$	$V_{EB}=(-)4V, I_C=0$			(-)100	nA
DC Current Gain	$h_{FE}$	$V_{CE}=(-)5V, I_C=(-)10mA$	100*		400*	
Gain-Bandwidth Product	$f_T$	$V_{CE}=(-)10V, I_C=(-)10mA$		150		MHz
Output Capacitance	$C_{ob}$	$V_{CB}=(-)10V, f=1MHz$		(4.0)		pF
				3.0		pF
Collector-to-Emitter Saturation Voltage	$V_{CE(sat)}$	$I_C=(-)50mA, I_B=(-)5mA$		(-0.14)	(-0.4)	V
				0.07	0.3	V
Turn-ON Time	$t_{on}$	See specified Test Circuit.		0.1		$\mu s$
Storage Time	$t_{stg}$	See specified Test Circuit.		1.5		$\mu s$
Fall Time	$t_f$	See specified Test Circuit.		0.1		$\mu s$

\* : The 2SA1415/2SC3645 are classified by 10mA  $h_{FE}$  as follows :

100	R	200	140	S	280	200	T	400
-----	---	-----	-----	---	-----	-----	---	-----

Marking 2SA1415 : AA                       $h_{FE}$  rank : R, S, T  
 2SC3645 : CA

# 2SA1415/2SC3645

## Switching Time Test Circuit

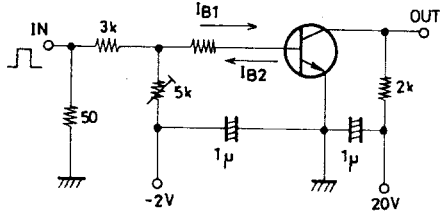

$$I_C = 10I_{B1} = 10I_{B2} = 10\text{mA}$$

(For PNP, the polarity is reversed)

Unit (resistance :  $\Omega$ , capacitance : F)

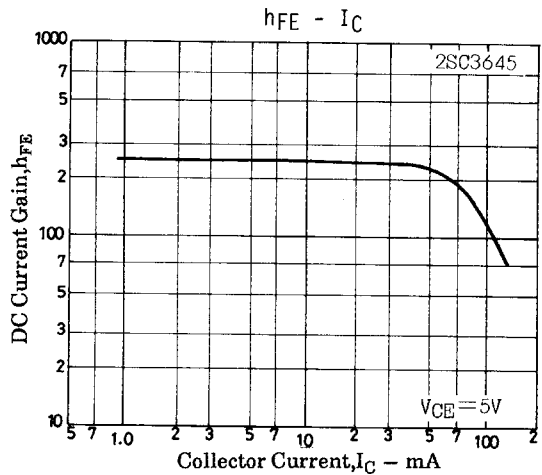
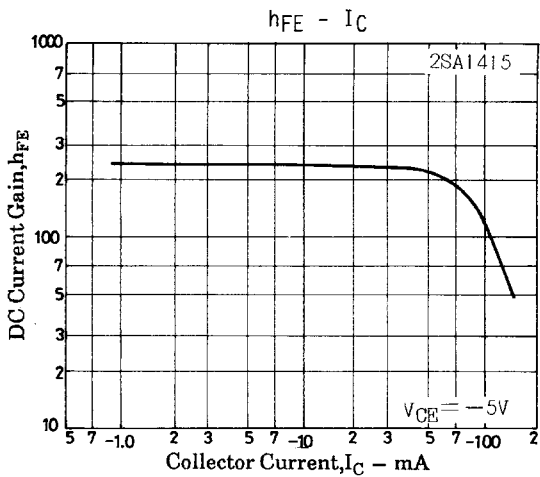
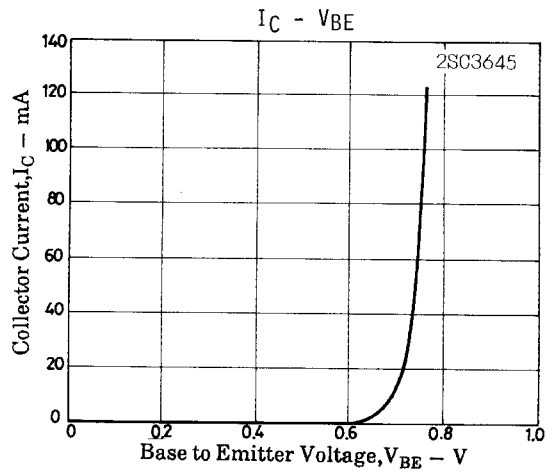
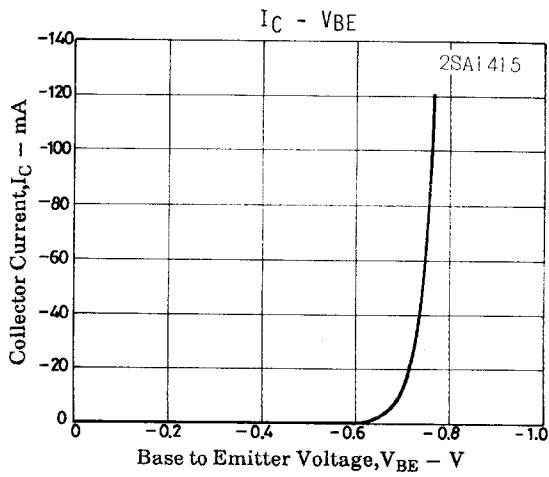
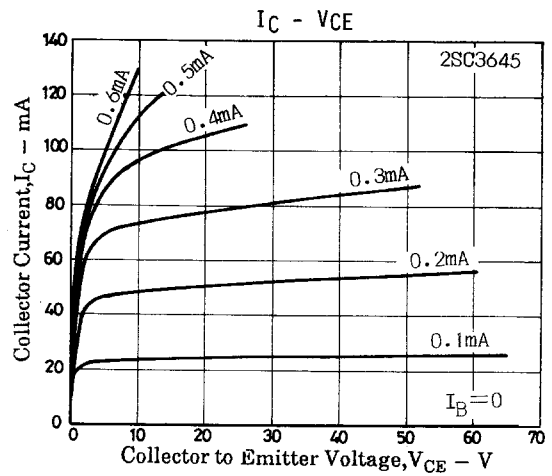
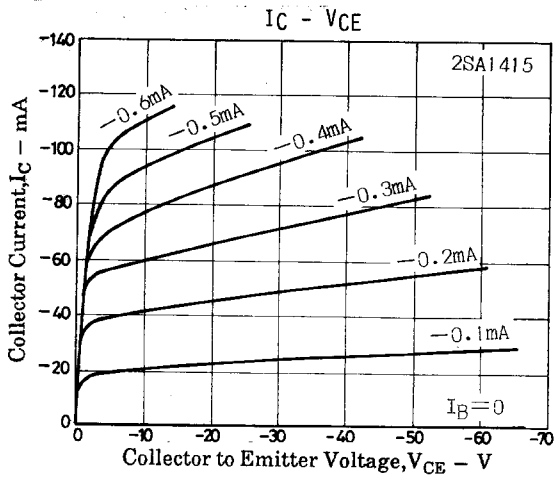

# 2SA1415/2SC3645

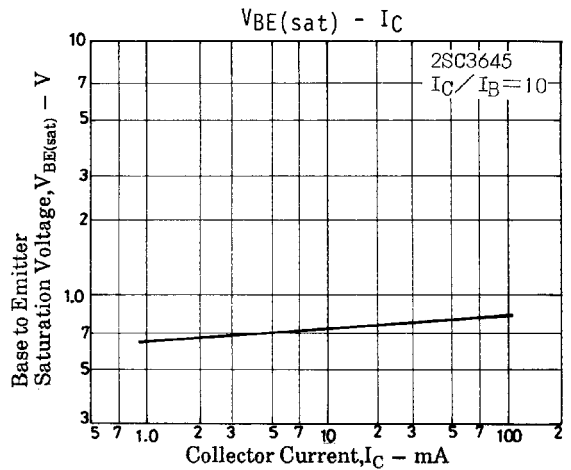
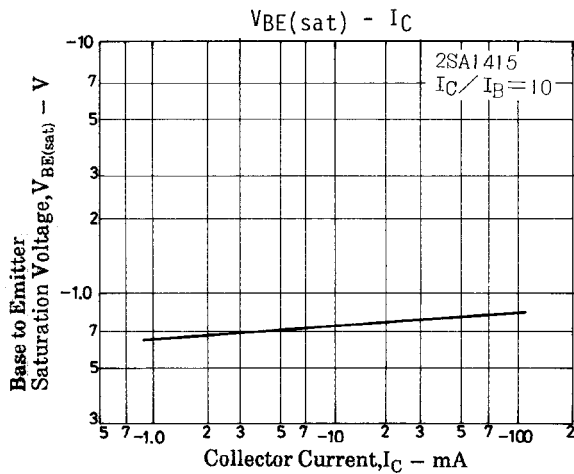
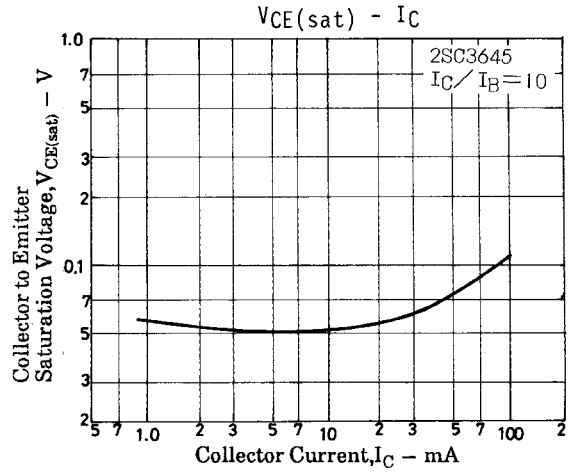
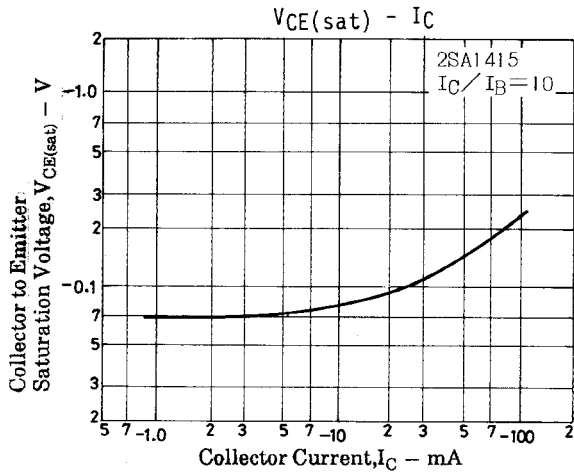
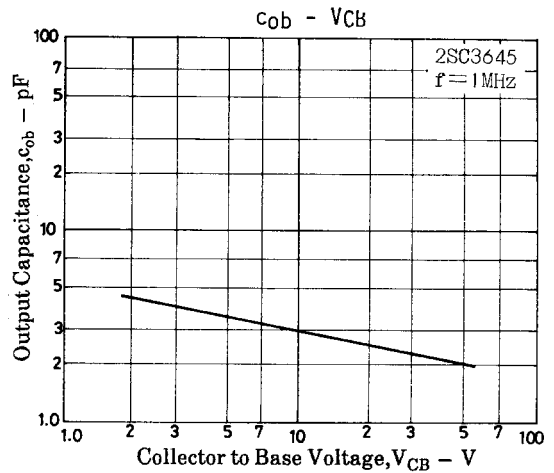
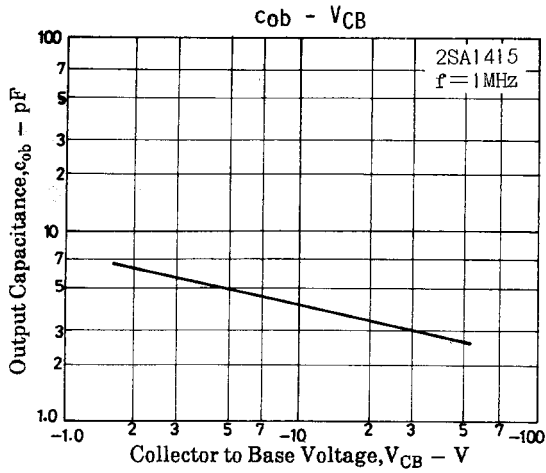
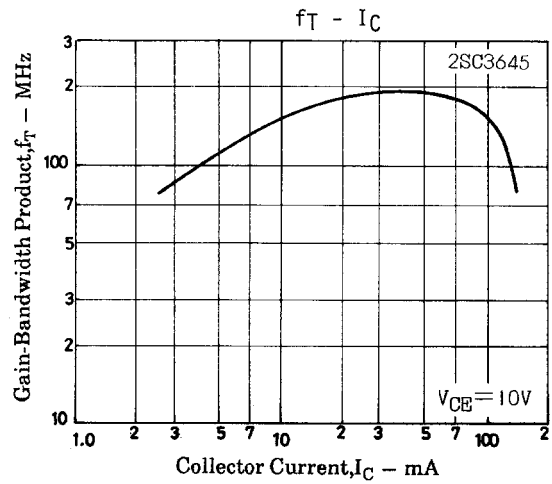
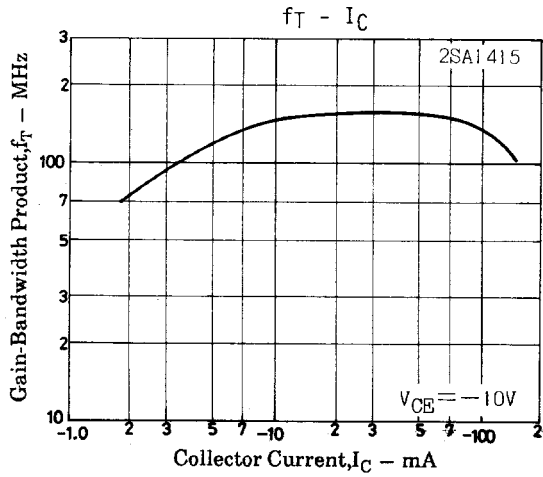

## 2SA1415/2SC3645

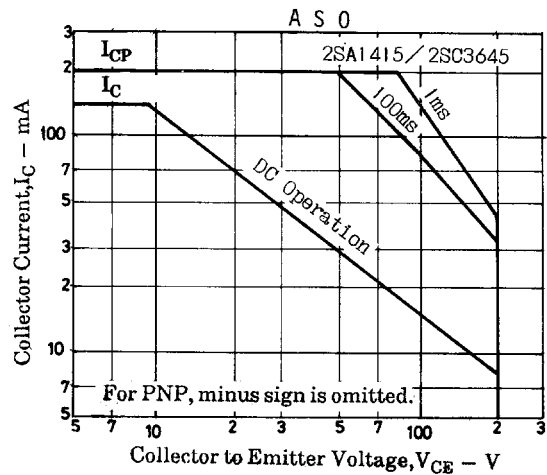
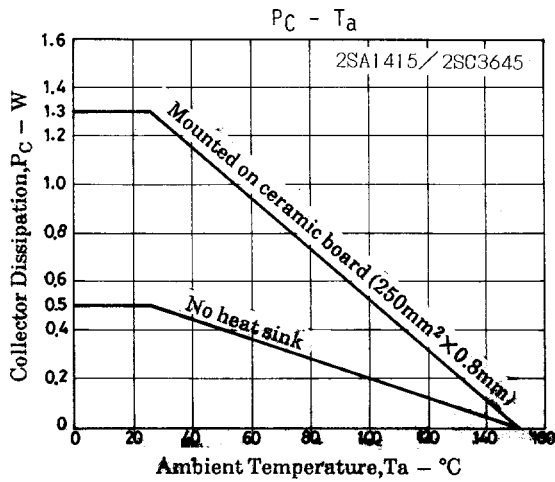

- No products described or contained herein are intended for use in surgical implants, life-support systems, aerospace equipment, nuclear power control systems, vehicles, disaster/crime-prevention equipment and the like, the failure of which may directly or indirectly cause injury, death or property loss.
- Anyone purchasing any products described or contained herein for an above-mentioned use shall:
  - ① Accept full responsibility and indemnify and defend SANYO ELECTRIC CO., LTD., its affiliates, subsidiaries and distributors and all their officers and employees, jointly and severally, against any and all claims and litigation and all damages, cost and expenses associated with such use:
  - ② Not impose any responsibility for any fault or negligence which may be cited in any such claim or litigation on SANYO ELECTRIC CO., LTD., its affiliates, subsidiaries and distributors or any of their officers and employees jointly or severally.
- Information (including circuit diagrams and circuit parameters) herein is for example only; it is not guaranteed for volume production. SANYO believes information herein is accurate and reliable, but no guarantees are made or implied regarding its use or any infringements of intellectual property rights or other rights of third parties.

This catalog provides information as of July, 1998. Specifications and information herein are subject to change without notice.