

Thick-film Hybrid Integrated Circuit (HIC)

<b>SANYO</b>	No. 4218	<b>STK4199MK2</b>
	<b>3-channel AF Power Amplifier (<math>\pm</math> Dual Power Supply)</b> 25 W + 50 W + 25 W	

## Overview

Recent audio-visual television sets generate more impressive images by making the images higher in quality. To do this, large screens providing high-quality images are essential. Along with this, the sound must also be powerful, and full of ambience and presence. To faithfully reproduce a powerful sound field, distortion-free bass output is indispensable. Because human ears can perceive left-right directionality only for frequencies above 200 Hz, a three-dimensional (3D) system using one woofer speaker is generally employed. Also, the Dolby Surround System, used in many movie theaters, exists as a system for reproducing a spatial sound field with presence. To achieve satisfying results in audio-visual televisions, these specifications require amplifiers for a correspondingly high number of channels. To meet these needs, the STK4199MK2 is a hybrid IC that provides power amplifiers for three channels (25 W + 50 W + 25 W) in a single package.

## Package Dimensions 4108

(unit : mm)

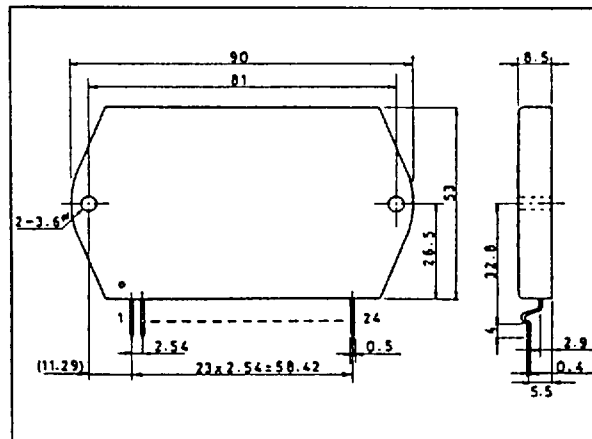

## Applications

- 3D surround amplifier
- 3D super woofer amplifier

## Features

- Uses substrate with IMST (insulated metal substrate technology)
- The  $\pm$  dual power supply provides a wide frequency band ( $f = 20$  Hz to 50 kHz)
- Easy dolby surround configuration
- Easy 3D amplifier configuration

The information (including circuits and circuit constants) given in this material is only for purpose of example, and should not be taken as any assurance for volume production set design. While we have made every effort to assure the accuracy and reliability of this information, no responsibility is assumed by Sanyo for any infringements of intellectual property or other rights of third parties. In the event that the items described in this document are strategic materials as defined by the Foreign Exchange and Foreign Trade Control Act, export licensing will be required for export.

Specifications and information herein are subject to change without notice.

**SANYO Electric Co., Ltd. Semiconductor Business Headquarters**

TOKYO OFFICE Tokyo Bldg., 1-10, 1 Chōme, Ueno, Taitō-ku, TOKYO JAPAN

STK4199MK2

Maximum Ratings at Ta = 25°C

Parameter	Symbol	Conditions	Value	Unit
Maximum supply voltage	V <sub>CC</sub> max	L,Rch	±39	V
		Cch	±52.5	V
Thermal resistance	θ <sub>j-c</sub>	L,Rch per power transistors	2.6	°C/W
		Cch per power transistors	1.8	°C/W
Junction temperature	T <sub>j</sub>		150	°C
Operating substrate temperature	T <sub>c</sub>		125	°C
Storage temperature	T <sub>stg</sub>		-30 to +125	°C
Permissible load short time	t <sub>s</sub>	L,Rch V <sub>CC</sub> =±26V, R <sub>L</sub> =8Ω, f=50Hz, P <sub>O</sub> =25W	2	sec
		Cch V <sub>CC</sub> =±35V, R <sub>L</sub> =8Ω, f=50Hz, P <sub>O</sub> =50W	2	sec

Operating Characteristics at Ta = 25°C, R<sub>L</sub> = 8Ω, R<sub>g</sub> = 600Ω, V<sub>G</sub> = 40dB, R<sub>L</sub> (non-inductive)

Parameter	Symbol	Conditions	min	typ	max	Unit
Output power	P <sub>O</sub> (1)	V <sub>CC</sub> =±26V, f=20 to 20kHz, THD=0.4%, L,Rch	25			W
		V <sub>CC</sub> =±35V, f=20 to 20kHz, THD=0.4%, Cch	50			W
		V <sub>CC</sub> =±22V, f=1kHz, THD=1.0%, L,Rch, R <sub>L</sub> =4Ω	25			W
		V <sub>CC</sub> =±31V, f=1kHz, THD=1.0%, Cch, R <sub>L</sub> =4Ω	55			W
Total harmonic distortion	THD(1)	V <sub>CC</sub> =±26V, f=1kHz, P <sub>O</sub> =1.0W, L,Rch			0.3	%
		V <sub>CC</sub> =±35V, f=1kHz, P <sub>O</sub> =1.0W, Cch			0.3	%
Frequency response	f <sub>L</sub> , f <sub>H</sub> (1)	V <sub>CC</sub> =±26V, P <sub>O</sub> =1.0W, THD=0 dB, L,Rch	20		50k	Hz
		V <sub>CC</sub> =±35V, P <sub>O</sub> =1.0W, THD=0 dB, Cch	20		50k	Hz
Input impedance	r <sub>i</sub> (1)	V <sub>CC</sub> =±26V, f=1kHz, P <sub>O</sub> =1.0W, L,Rch		55		kΩ
		V <sub>CC</sub> =±35V, f=1kHz, P <sub>O</sub> =1.0W, Cch		55		kΩ
Output noise voltage	V <sub>NO</sub> (1)	V <sub>CC</sub> =±31V, R <sub>g</sub> =10kΩ, L,Rch			1.2	mVrms
		V <sub>CC</sub> =±42V, R <sub>g</sub> =10kΩ, Cch			1.2	mVrms
Quiescent current	I <sub>CCO</sub> (1)	V <sub>CC</sub> =±31V, L,Rch	20	40	100	mA
		V <sub>CC</sub> =±42V, Cch	10	20	50	mA
Midpoint voltage	V <sub>N</sub> (1)	V <sub>CC</sub> =±31V, L,Rch	-70	0	+70	mV
		V <sub>CC</sub> =±42V, Cch	-70	0	+70	mV

Notes

- Use rated power supply for test unless otherwise specified. However, the L and R channels use ±V<sub>CC</sub>(1) power supply, and the C channel uses ±V<sub>CC</sub>(2) power supply.
- When measuring permissible load short time and output noise voltage use transformer power supply indicated below.
- Output noise voltage is represented by the peak value rms (VTVM) for mean reading. Use an AC stabilized power supply (50 Hz) on the primary side to eliminate the effect of AC flicker noise.

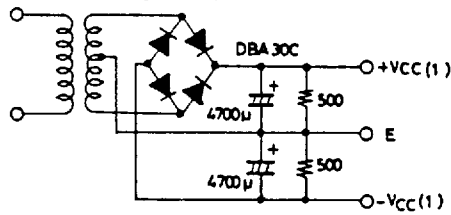

Specified Transformer Power Supply (PR-25 Equivalent)

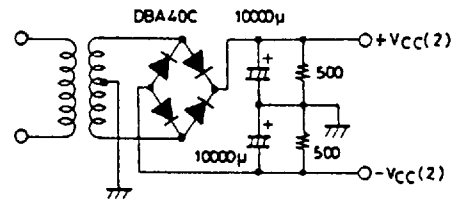

Specified Transformer Power Supply (MG-200 Equivalent)

Equivalent Circuit

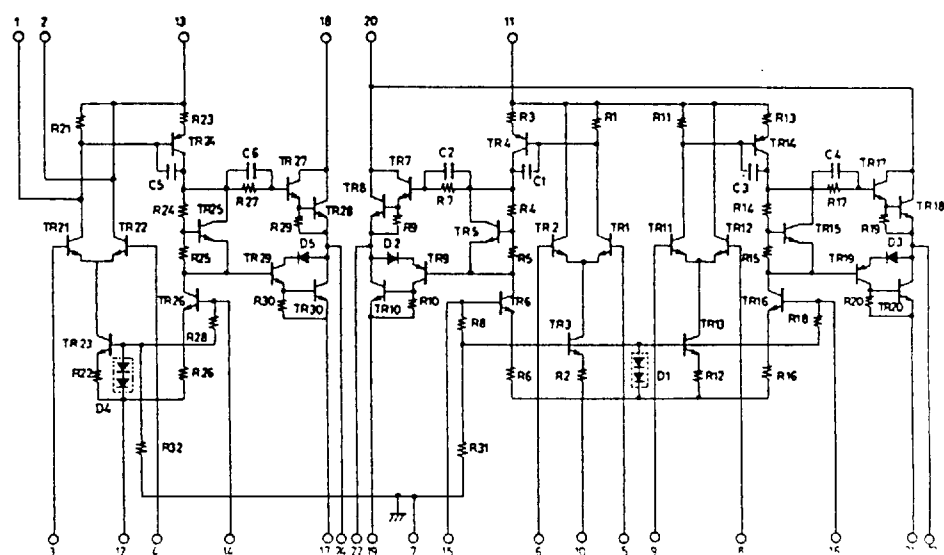

STK4199MK2

Application Circuit

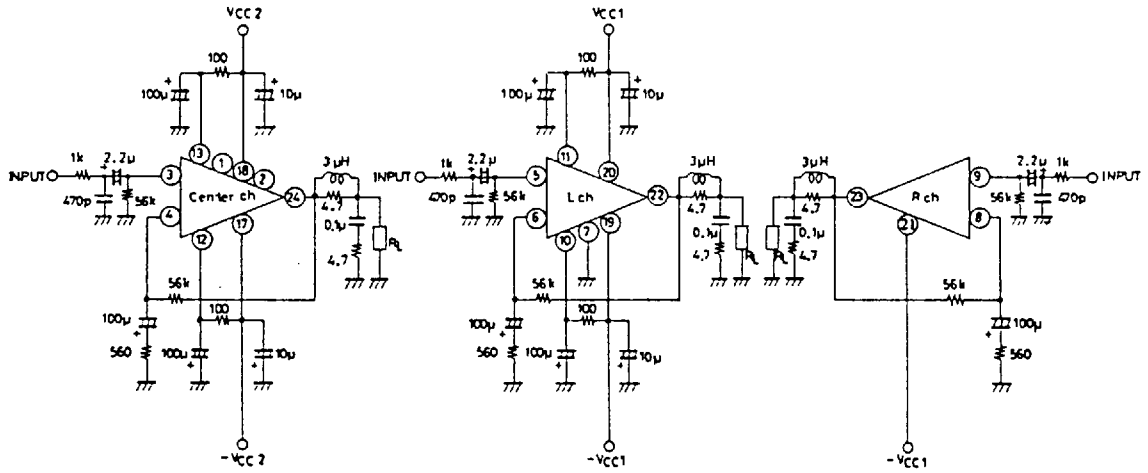

PCB Pattern

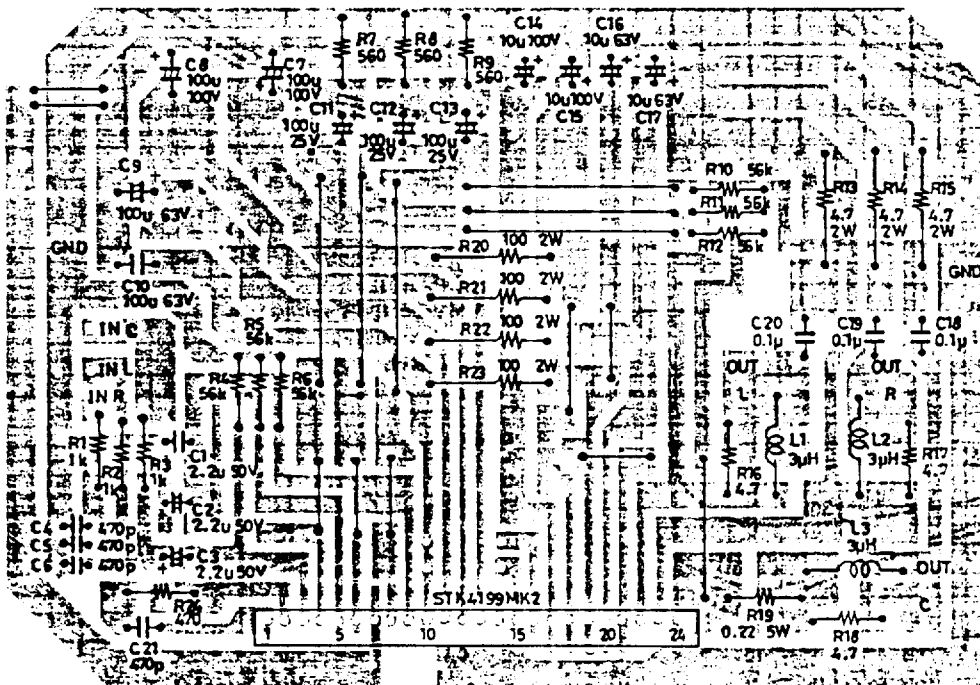

STK4199MK2

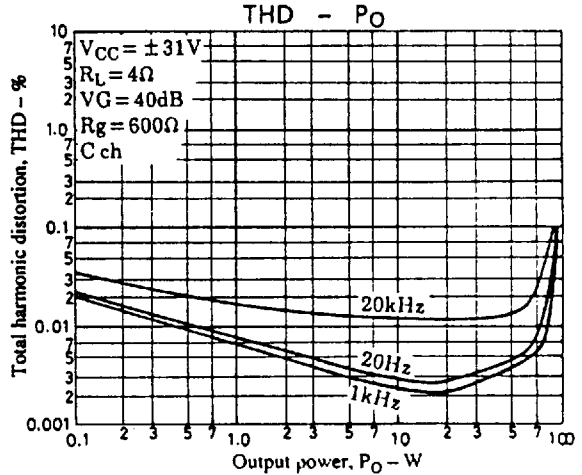
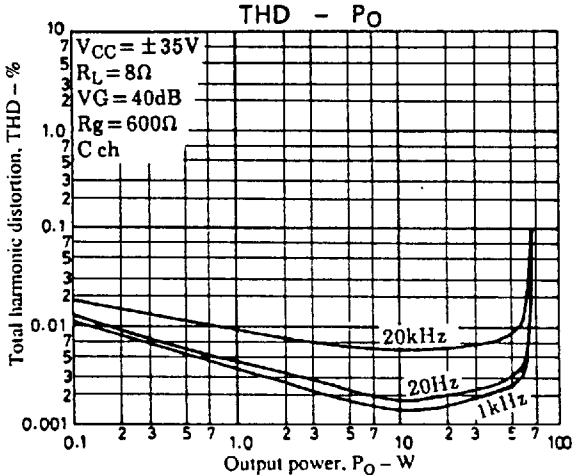
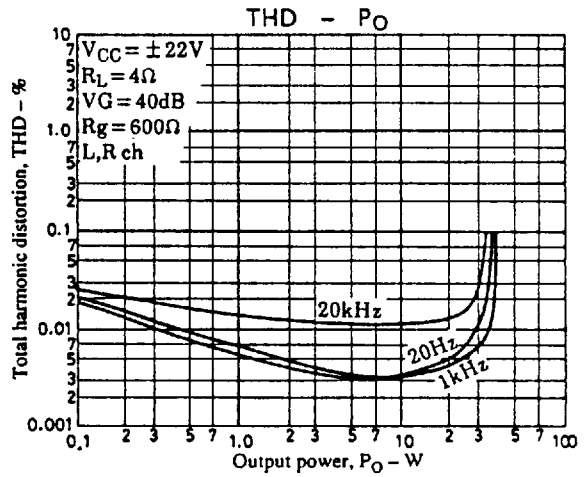
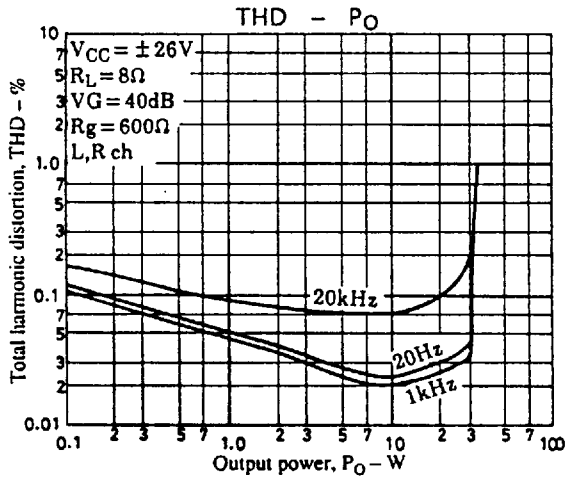
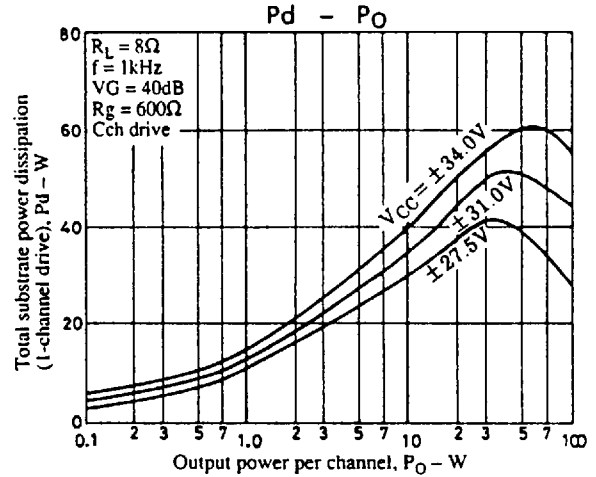
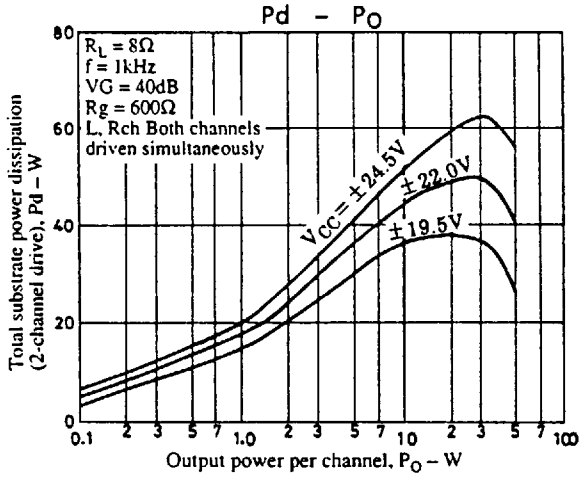
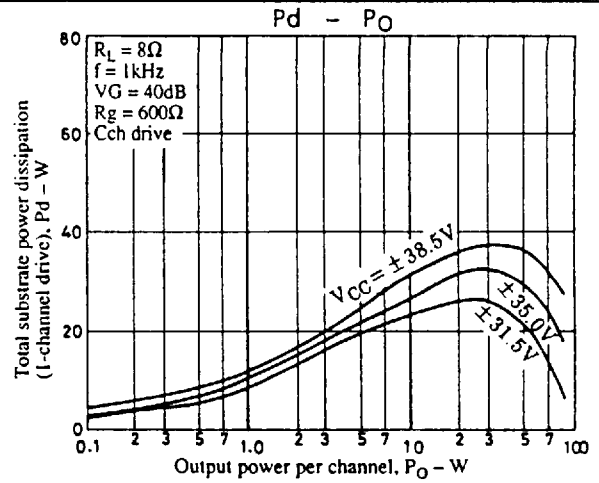
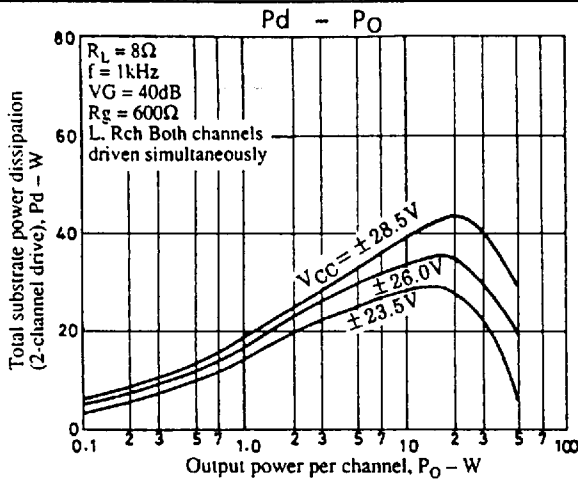

STK4199MK2

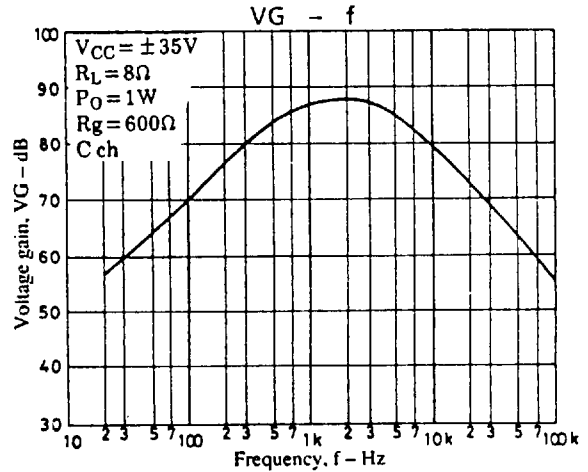
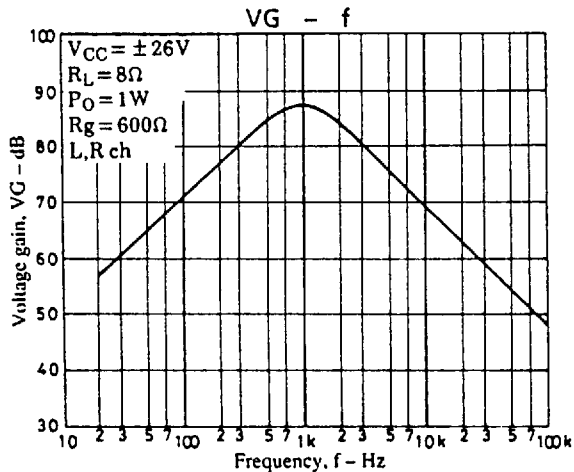
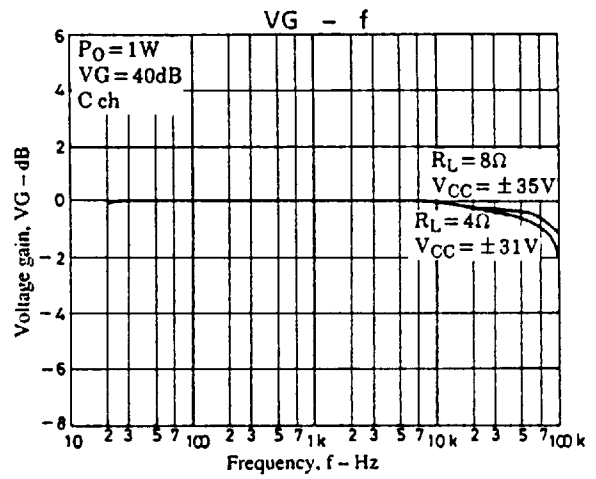
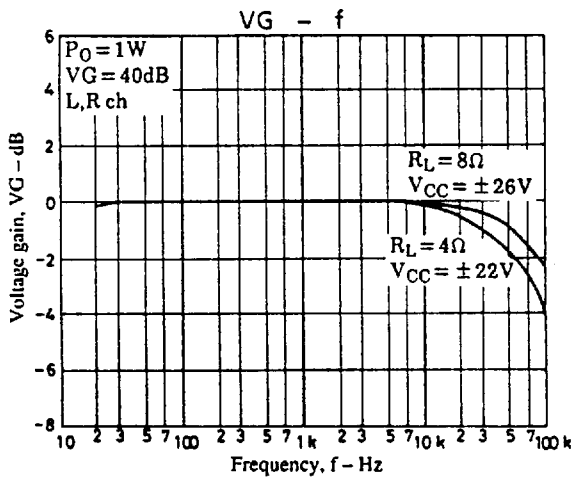
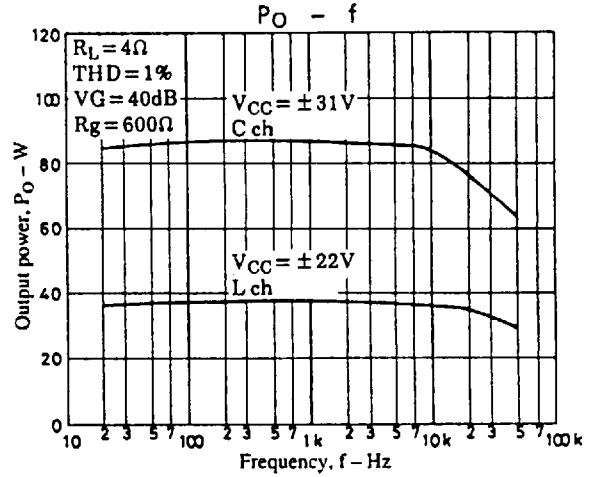
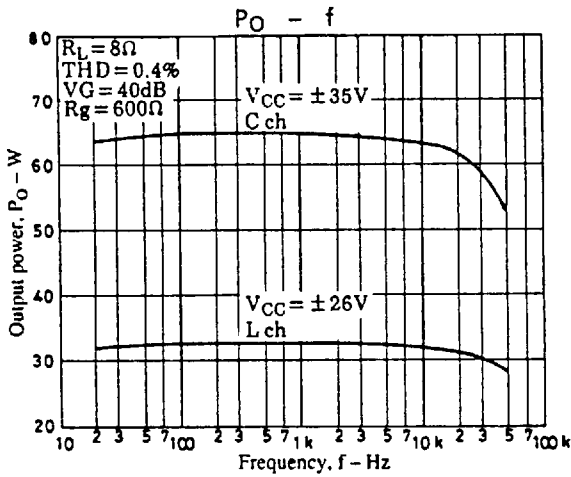
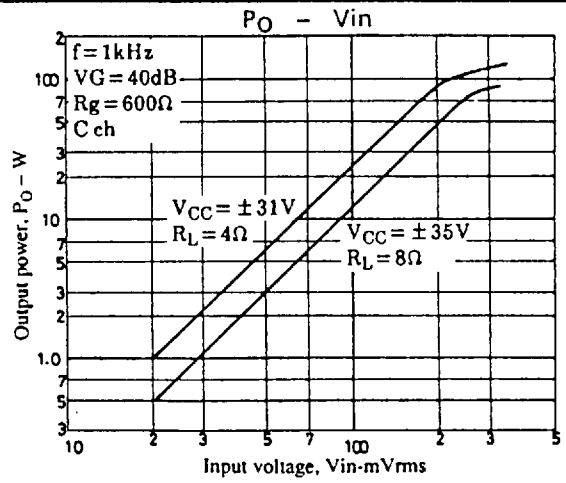
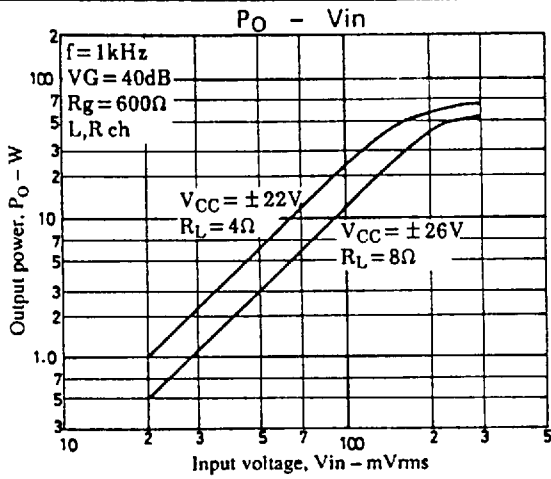

STK4199MK2

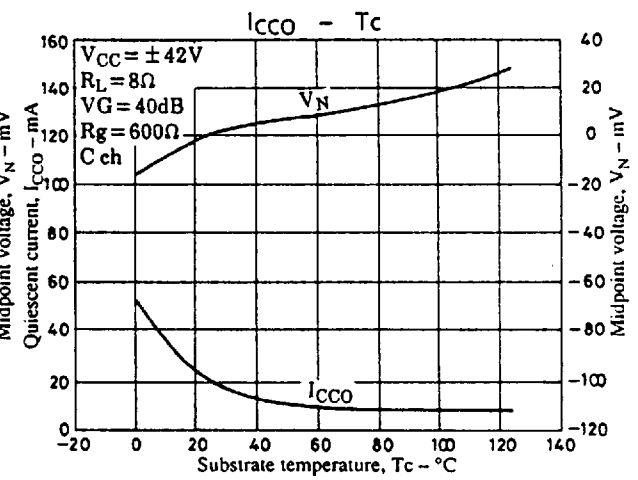
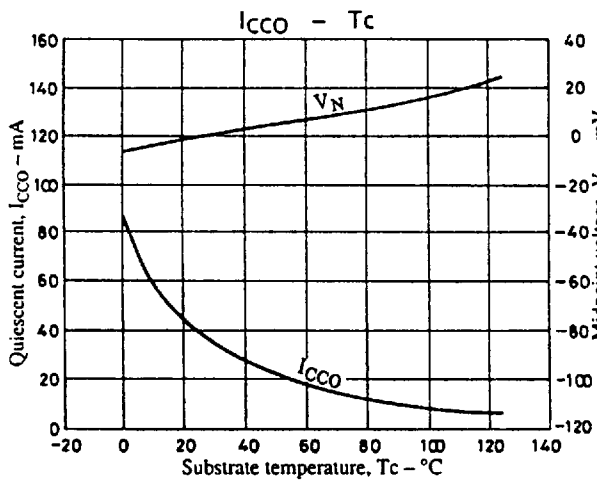
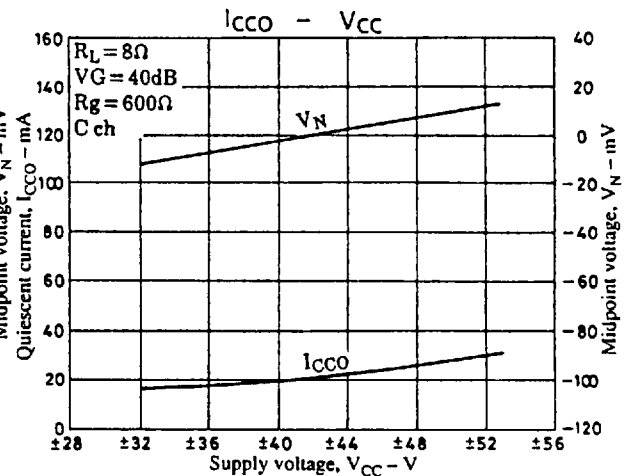
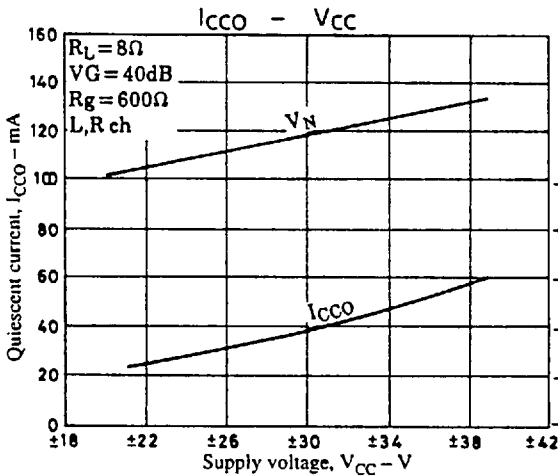
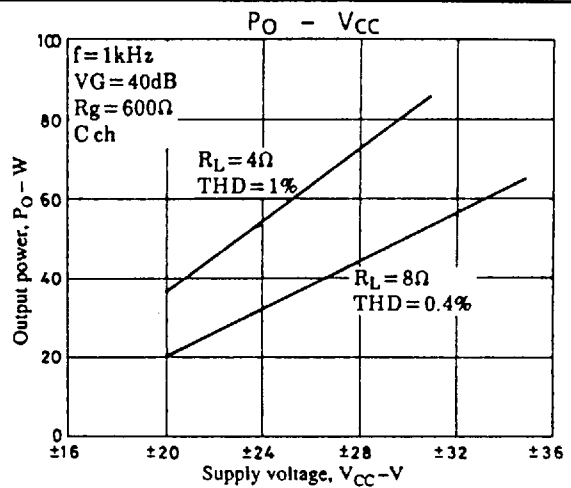
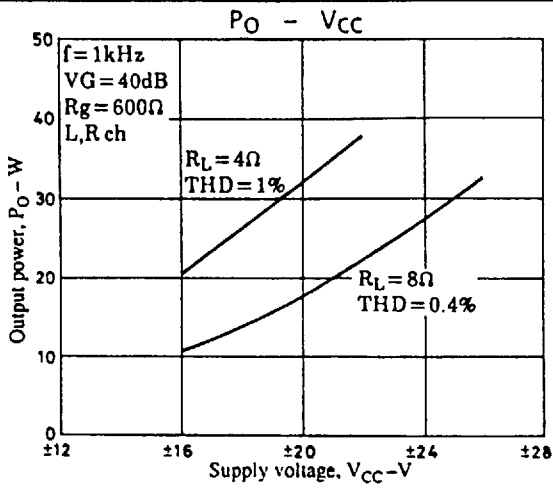

6

STK4199MK2

Pin Compatibility with Other Series

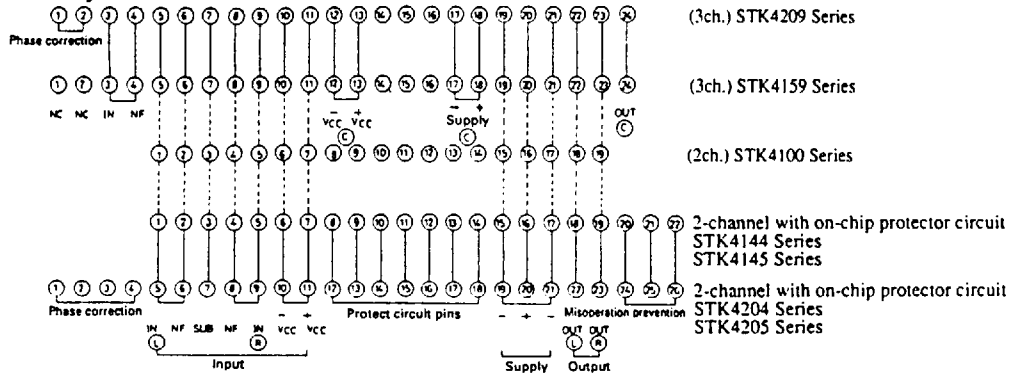

Explanation of pin compatibility

- STK4100 Series ← → STK4159 Series, STK4209 Series
- STK4100 Series ← → STK4144, STK4145 Series, STK4204, STK4205 Series

Note: Protect circuits for 2- and 3-channel chips are not compatible.

STK4199MK2 Heat Radiation Design Considerations

The radiator thermal resistance  $\theta_{c-a}$  required for substrate power dissipation  $P_d$  in the STK4199MK2 is determined as:

Condition 1: IC substrate temperature  $T_c$  not to exceed 125°C.

$$\text{Total } P_d \times \theta_{c-a} + T_a < 125^\circ\text{C} \dots\dots\dots (1)$$

$T_a$  : Set assured ambient temperature.  
Total  $P_d$  :  $Lch P_d + Rch P_d + Cch P_d$

Condition 2: Power transistor junction temperature  $T_j$  not to exceed 150°C.

$$\text{Total } P_d \times \theta_{c-a} + (Lch P_d + Rch P_d) / N \times \theta_{j-c} + T_a < 150^\circ\text{C} \dots\dots\dots (2)$$

$$\text{Total } P_d \times \theta_{c-a} + Cch P_d / N' \times \theta'_{j-c} + T_a < 150^\circ\text{C} \dots\dots\dots (3)$$

- $N$  : The number of Lch, Rch power transistors
  - $N'$  : The number of Cch power transistors
  - $\theta_{j-c}$  : The thermal resistance per Lch, Rch power transistor chip
  - $\theta'_{j-c}$  : The thermal resistance per Cch power transistor chip
- However, power transistor power consumption is  $P_d$  equally divided by  $N$  units.

Expressions (1), (2), and (3) can be rewritten based on  $\theta_{c-a}$  to yield:

$$\theta_{c-a} < (125 - T_a) / \text{Total } P_d \dots\dots\dots (1')$$

$$\theta_{c-a} < (150 - T_a) / \text{Total } P_d - (Lch P_d + Rch P_d) \times \theta_{j-c} / (\text{Total } P_d \times N) \dots\dots\dots (2')$$

$$\theta_{c-a} < (150 - T_a) / \text{Total } P_d - Cch P_d \times \theta'_{j-c} / (\text{Total } P_d \times N') \dots\dots\dots (3')$$

The value that simultaneously satisfies all three expressions is the thermal resistance required of the radiator. From expressions (1)', (2)', and (3)', the required radiator thermal resistance can be determined once the following specifications are known:

- Supply voltage  $V_{CC}$
- Load resistance  $R_L$
- Assured ambient temperature  $T_a$

The total substrate power consumption when STK4199MK2  $V_{CC}$  for the L and R channels is  $\pm 26$  V,  $V_{CC}$  for the C channel is  $\pm 35$  V, and  $R_L$  is 8  $\Omega$ , for a continuous sine wave signal, is a maximum of 35.5 W for the L plus R channels and 35.5 W for the C channel (Figs. 1 and 2). In general, when this sort of continuous signal is used for estimation of power consumption, the  $P_d$  used is 1/10th of  $P_O$  max (slight variation depending on safety standard).

$$\begin{aligned} Lch P_d + Rch P_d &= 24.5W \quad (1/10 P_O \text{ max} = \text{during } 2.5W) \\ Cch P_d &= 22W \quad (1/10 P_d \text{ max} = \text{during } 5.0W) \\ \text{Total } P_d &= Lch P_d + Rch P_d + Cch P_d = 46.5W \end{aligned}$$

The STK4199MK2 has four power transistors for the L and R channels ( $N$ ) and two for the C channel ( $N'$ ), so the thermal resistance per L and R channel transistor ( $\theta_{j-c}$ ) is 2.6°C / W and 1.8°C / W per C channel transistor ( $\theta'_{j-c}$ ). With an assured ambient temperature  $T_a$  of 50°C, the required radiator thermal resistance  $\theta_{c-a}$  would be:

$$\begin{aligned} \text{From expression (1)'} \quad \theta_{c-a} &< (125 - 50) / 46.5 < 1.612 \\ \text{From expression (2)'} \quad \theta_{c-a} &< (150 - 50) / 46.5 - 24.5 \times 2.6 / (46.5 \times 4) < 1.808 \\ \text{From expression (3)'} \quad \theta_{c-a} &< (150 - 50) / 46.5 - 22 \times 1.8 / (46.5 \times 2) < 1.724 \end{aligned}$$

To satisfy both, 1.339°C / W is the required radiator thermal resistance. This design example is based on a fixed voltage supply, and will require verification within your specific set environment.