



LA1833N, 1833NM

System-on-Chip Tuner IC for Home Stereo Systems

Overview

The LA1833N/NM is an AM/FM IF and MPX system-on-chip IC that supports electronic tuning for home stereo systems. It is optimal for use in auto-seek systems that use SD (station detect) and IF counting in parallel.

Functions

- AM: RF amplifier, mixer, oscillator, IF amplifier, detector, AGC, SD, oscillator buffer, IF buffer, and stereo IF output
- FM IF: IF amplifier, quadrature detector, S meter, SD, S-curve detector, IF buffer
- MPX: PLL stereo decoder, stereo indicator, forced mono, VCO stop, audio muting, adjacent channel interference reduction function, pilot canceller

Features

- Improvements over the LA1832
 - The MPX VCO circuit has been integrated on the same IC (no ceramic element required)
 - Built-in adjacent channel interference reduction function (114 kHz, 190 kHz)
 - Built-in pilot canceler function (19 kHz)
 - AM and FM output levels can be set independently
 - Improved FM reception characteristics (IF beating improved)
- Other features
 - Pin arrangement nearly identical to that of the LA1832
 - AM coil specifications can be the same as those used for the LA1832.
 - ST operating dynamic range improved over that of the LA1833

— FM total harmonic distortion detuning characteristics and signal-to-noise ratio improved over those of the LA1833

Package Dimensions

unit: mm

3112A-MFP24S

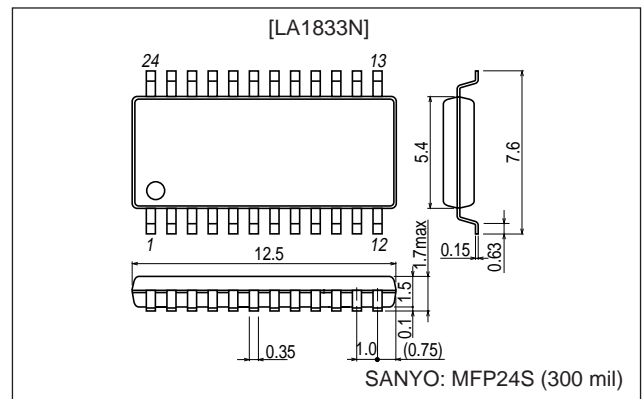

unit: mm

3067A-DIP24S

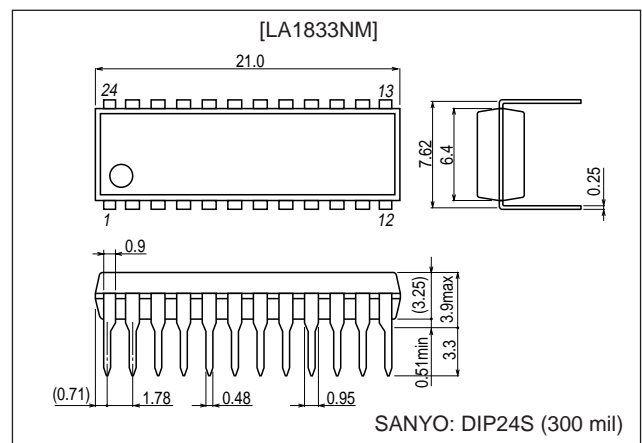

■ Any and all SANYO products described or contained herein do not have specifications that can handle applications that require extremely high levels of reliability, such as life-support systems, aircraft's control systems, or other applications whose failure can be reasonably expected to result in serious physical and/or material damage. Consult with your SANYO representative nearest you before using any SANYO products described or contained herein in such applications.

■ SANYO assumes no responsibility for equipment failures that result from using products at values that exceed, even momentarily, rated values (such as maximum ratings, operating condition ranges, or other parameters) listed in products specifications of any and all SANYO products described or contained herein.

SANYO Electric Co., Ltd. Semiconductor Company

TOKYO OFFICE Tokyo Bldg., 1-10, 1 Chome, Ueno, Taito-ku, TOKYO, 110-8534 JAPAN

LA1833N, 1833NM

Specifications

Maximum Ratings at Ta = 25°C

Parameter	Symbol	Conditions	Ratings	Unit
Maximum supply voltage	V _{CC} max		9	V
Allowable power dissipation	Pd max	(LA1833N)	400	mW
		(LA1833NM) (Ta ≤ 45°C)	400	mW
		(LA1833NM) (Ta = 70°C)	270	mW
Operating temperature	Topr		-20 to +70	°C
Storage temperature	Tstg		-40 to +125	°C

Operating Conditions at Ta = 25°C

Parameter	Symbol	Conditions	Ratings	Unit
Recommended supply voltage	V _{CC}		5	V
Operating supply voltage range	V _{CC} op		4 to 8	V

Electrical Characteristics at V_{CC} = 5 V, in the specified test circuit

Parameter	Symbol	Conditions	Ratings			Unit
			min	typ	max	
[FM Mono Characteristics: fc = 10.7 MHz, fm = 1 kHz]						
Current drain	I _{CCO-FM}	No input	18	28	38	mA
Demodulator output	V _{O-FM}	100 dBμ, 100% mod. The pin 13 output	210	330	420	mVrms
Channel balance	C.B-mono	100 dBμ, 100% mod. The ratio (pin 13 output)/(pin 14 output)	-1.5	0	1.5	dB
Total harmonic distortion (mono)	THD-FM	100 dBμ, 100% mod. The pin 13 output		0.5	1.5	%
Signal-to-noise ratio	S/N-FM	100 dBμ, 100% mod. The pin 13 output	70	78		dB
AM rejection ratio	AMR	100 dBμ, AM = 30% mod. fm = 1 kHz	45	63		dB
Input limiting voltage	-3dB _L S	100 dBμ, 100% mod. The pin 13 output Referenced to the output, when the input is down by -3 dB		34	42	dBμ
SD LED on sensitivity	SD-On-FM		32	42	52	dBμ
IF counter buffer output	V _{IFBuff-FM}	100 dBμ, the pin 10 output	200	275	400	mVrms
Muting attenuation	Mute Att	100 dBμ, 100% mod. fm = 1 kHz		76		dB
[Stereo Characteristics: fc = 10.7 MHz, 100 dBμ, fm = 1 kHz, L + R = 90%, pilot = 10%]						
Separation	Sep	Left channel modulated, the ratio (pin 13 output)/(pin 14 output)	28	42		dB
Stereo on level	ST-on	The pilot modulation level such that V7 becomes less than 0.7 V	1.5	3.5	5.5	%
Total harmonic distortion (main)	THD-main	L + R modulation, the pin 13 output		0.7	1.5	%
Adjacent channel interference rejection ratio	Brej-3rd	fs = 113 kHz, Vs = 90%, Pilot = 10%; the pin 13 output with respect to an L - R modulated 1 kHz demodulator output		36		dB
Adjacent channel interference rejection ratio	Brej-5th	fs = 189 kHz, Vs = 90%, Pilot = 10%; the pin 13 output with respect to an L - R modulated 1 kHz demodulator output		41		dB
Carrier leakage	CL	L + R = 90%, De-emph asis 50 μs, Pilot = 10%	38	44		dB
[AM Characteristics: fc = 1000 kHz, fm = 1 kHz]						
Current drain	I _{CCO-AM}	No input	11	22	33	mA
Detector output	V _{O-AM} (1)	23 dBμ, 30% modulation. The pin 13 output	40	80	160	mVrms
Detector output	V _{O-AM} (2)	80 dBμ, 30% modulation. The pin 13 output	90	160	230	mVrms
Signal-to-noise ratio	S/N-AM (1)	23 dBμ, 30% modulation. The pin 13 output	16	21		dB
	S/N-AM (2)	80 dBμ, 30% modulation. The pin 13 output	48	54		dB
Total harmonic distortion	THD-AM (1)	80 dBμ, 30% modulation. The pin 13 output		0.4	1.1	%
	THD-AM (2)	100 dBμ, 30% modulation. The pin 13 output		0.5	1.3	%
SD LED on sensitivity	SD-On-AM		14	24	34	dBμ
Local oscillator buffer output	V _{OSC-AM}	No input, the pin 24 output	140	200		mVrms
IF counter buffer output	V _{IFBuff-AM}	80 dBμ, no modulation, the pin 10 output	140	285	400	mVrms

LA1833N, 1833NM

Pin Descriptions

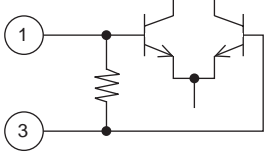
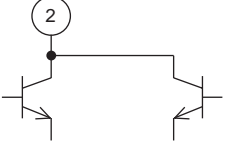
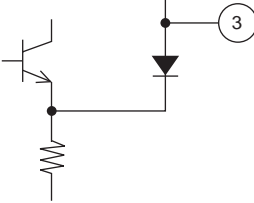
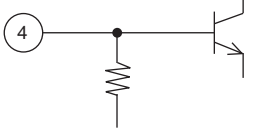
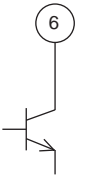
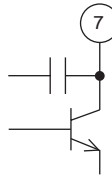
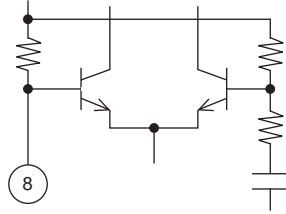
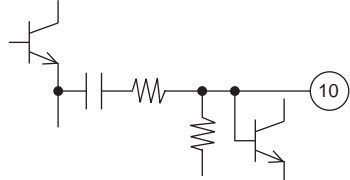
Pin No.	Pin	Voltage (V)	Functional description	Equivalent circuit
1	FM IF input	Vreg	The input impedance, r_i , is 330 Ω	 <p>ILA00220</p>
2	AM MIX output	V _{CC}	The mixer coil is connected between pins 2 and 9	 <p>ILA00221</p>
3	REG	2.1	Vreg = 2.1 V	 <p>ILA00222</p>
4	AM IF input	Vreg	The input impedance, r_i , is 2 k Ω	 <p>ILA00223</p>
5	GND	0		
6	Tu-LED	V _{CC}	These are active-low open-collector outputs. Set up the current flowing in to these pins to exceed 100 μ A.	  <p>ILA00224</p>
7	ST-LED Also functions as the AM stereo IF output			
8	FM-DET	V _{CC} - 2.1	Recommended ceramic discriminators FCD1070MA11UK2L (TDK) CDA10.7MG86N (Murata Mfg. Co., Ltd.)	 <p>ILA00225</p>
9	V _{CC}	5.0		
10	AM/FM IF counter output Also functions as a control switch Also functions as the muting switch	0	V ₁₀ ≤ 0.5 V: Reception state (normal) 1.4 V ≤ V ₁₀ ≤ 2.2 V: Muting on state. V ₁₀ ≥ 3.5 V: Muting on and IF counter on (seek state).	 <p>ILA00226</p>

Continued on next page.

LA1833N, 1833NM

Continued from preceding page.

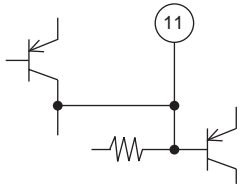
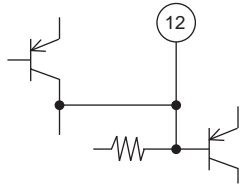
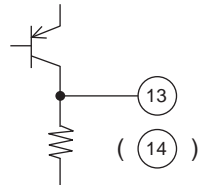
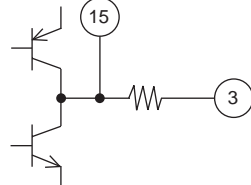
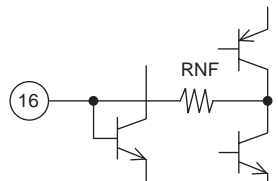
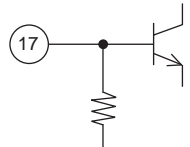
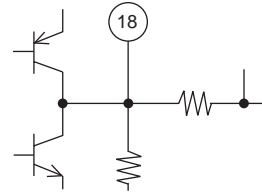
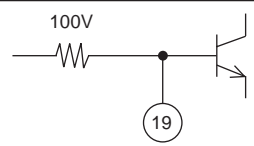
Pin No.	Pin	Voltage (V)	Functional description	Equivalent circuit
11	Phase comparator filter connection Also functions as the FM/AM switching input	$V_{CC} - 1.0$	The IC switches to AM mode if a current in excess of $200 \mu\text{A}$ flows from this pin	 <p style="text-align: right;">ILA00227</p>
12	Pilot detector filter connection Also functions as the forced mono setting Also functions as the VCO stop control	$V_{CC} - 1.0$	The IC switches to forced mono mode if a current in excess of $50 \mu\text{A}$ flows from this pin. The VCO circuit is stopped if a current in excess of $200 \mu\text{A}$ flows from this pin.	 <p style="text-align: right;">ILA00228</p>
13 14	Left output Right output	1.8	The output impedance, r_o , is $3.3 \text{ k}\Omega$	 <p style="text-align: right;">ILA00229</p>
15	Pilot canceller output	V_{reg}		 <p style="text-align: right;">ILA00230</p>
16	Decoder input	V_{reg}	Inverting input $R_{NF} = 20 \text{ k}\Omega$	 <p style="text-align: right;">ILA00231</p>
17	PLL input	V_{reg}	The input impedance, r_i , is $20 \text{ k}\Omega$	 <p style="text-align: right;">ILA00232</p>
18	FM demodulator output	V_{reg}	The output impedance, r_o , is $2.3 \text{ k}\Omega$. The separation can be adjusted by changing the value of the capacitor connected between this pin and ground.	 <p style="text-align: right;">ILA00233</p>
19	AM detector output	0 (FM) 1.5 (AM)	The output impedance, r_o , is $10 \text{ k}\Omega$	 <p style="text-align: right;">ILA00234</p>

Continued on next page.

LA1833N, 1833NM

Continued from preceding page.

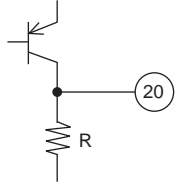
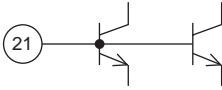
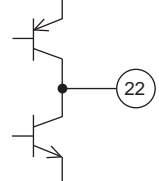
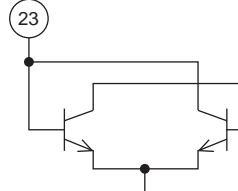
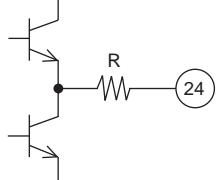
Pin No.	Pin	Voltage (V)	Functional description	Equivalent circuit
20	S meter Also functions as the AM AGC	0.2 (FM) 0.9 (AM)	Internal load resistor $R = 13.9 \text{ k}\Omega$. The SD response speed during seek operations is set by the value of the external capacitor connected to pin 20.	 <p>ILA00235</p>
21	AM RF-IN	V_{reg}	Pin 21 and pin 22 (the AFC voltage) are used at the same potential	 <p>ILA00236</p>
22	AFC	V_{reg}	The FM SD bandwidth can be adjusted by an external resistor connected between pin 22 and pin 3 (the regulator voltage). Note: A bandwidth of 180 kHz or higher is appropriate for the FM SD bandwidth.	 <p>ILA00237</p>
23	OSC	V_{CC}	The oscillator coil is connected between pin 23 and pin 9 (the V_{CC} voltage). Note: The oscillator coil impedance (secondary side) must be at least $5 \text{ k}\Omega$.	 <p>ILA00238</p>
24	Oscillator buffer Also functions as the FM SD adjustment	$V_{CC} - 1.4$	The FM SD sensitivity can be adjusted with an external resistor on pin 24. $R = 200 \Omega$ Note: The resistance of the pin 24 external resistor must be at least $3.3 \text{ k}\Omega$.	 <p>ILA00239</p>

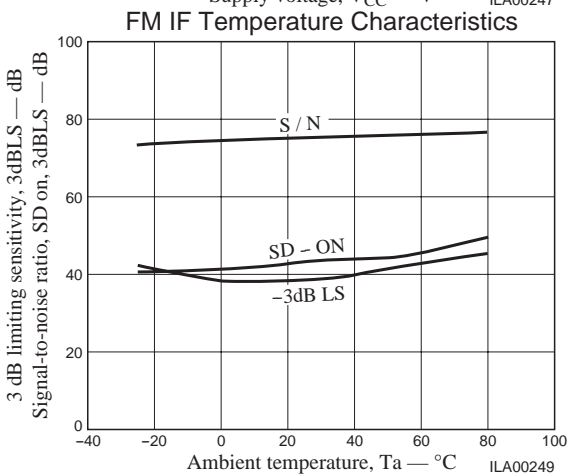
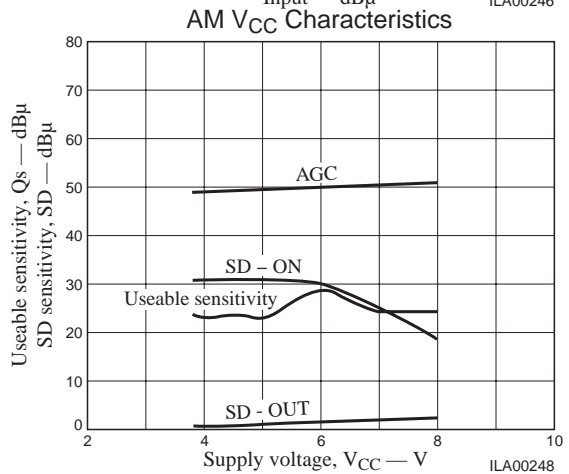
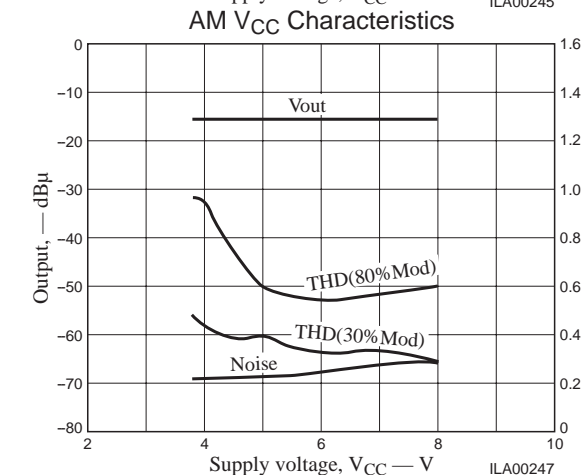
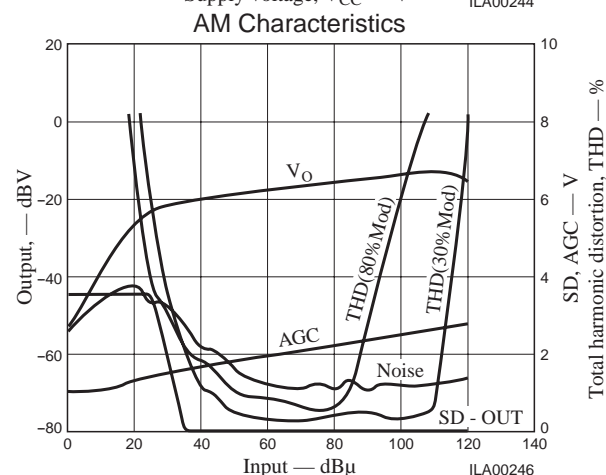
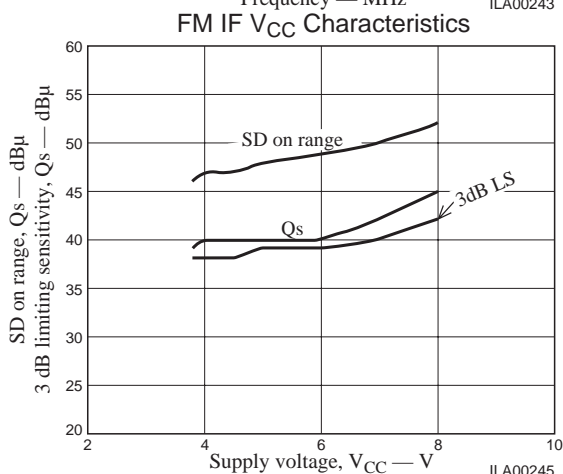
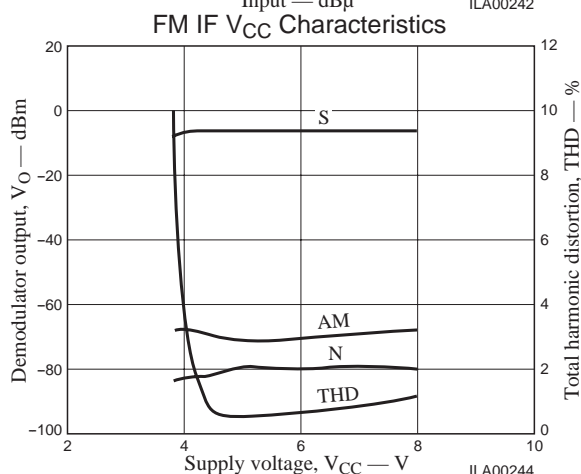
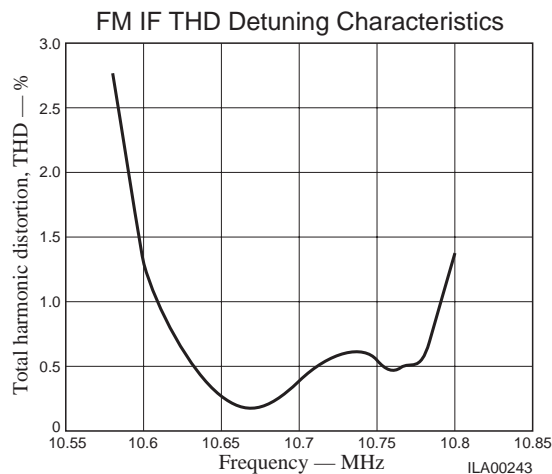
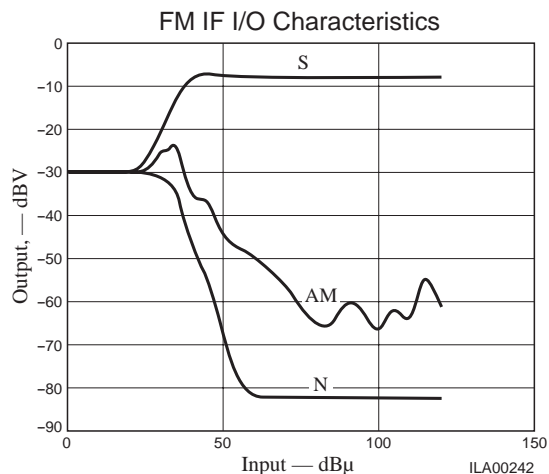

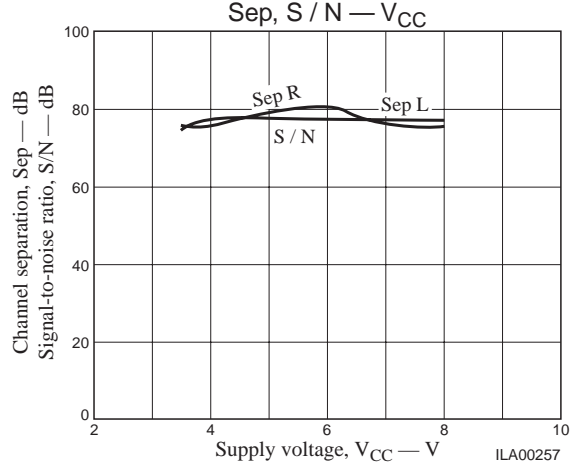
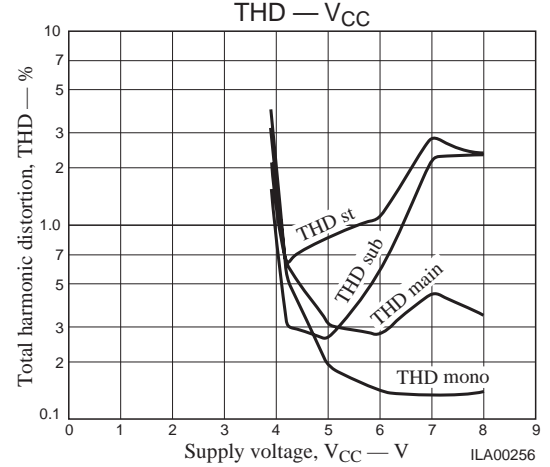
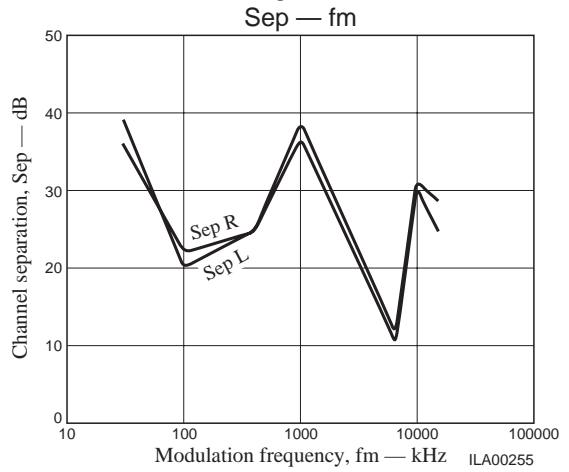
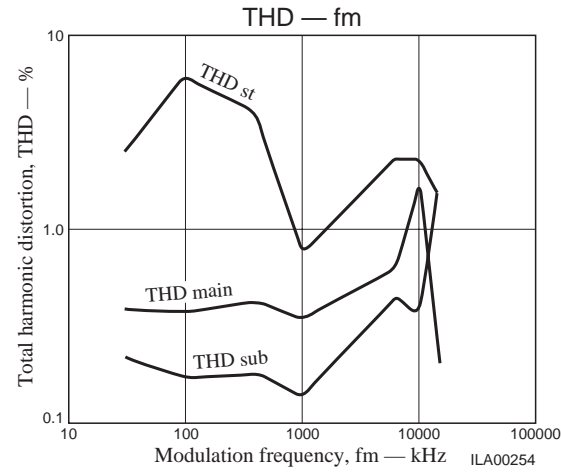
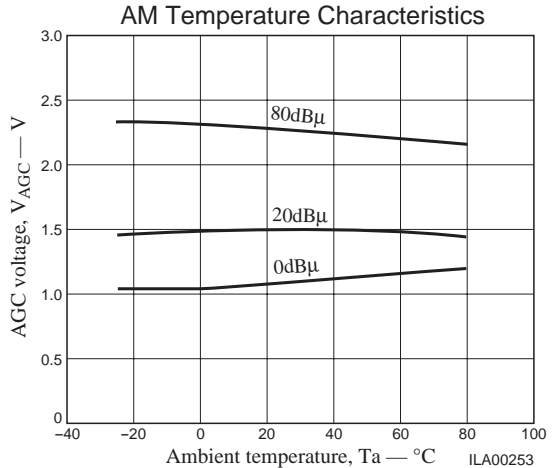
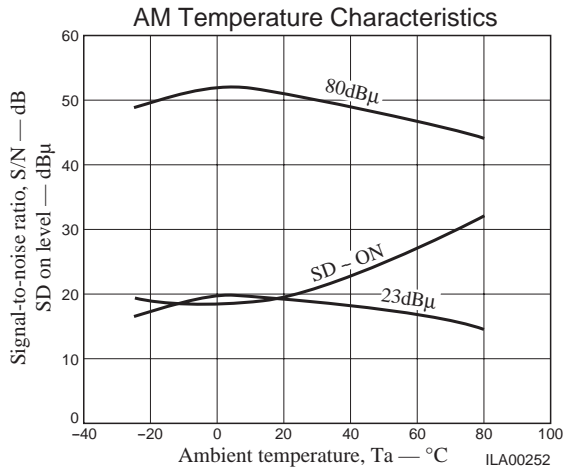
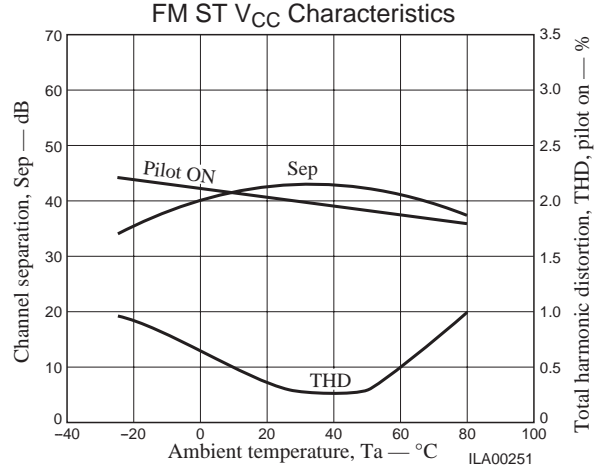
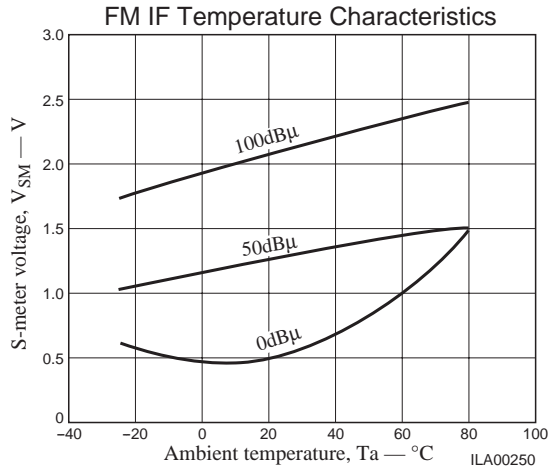

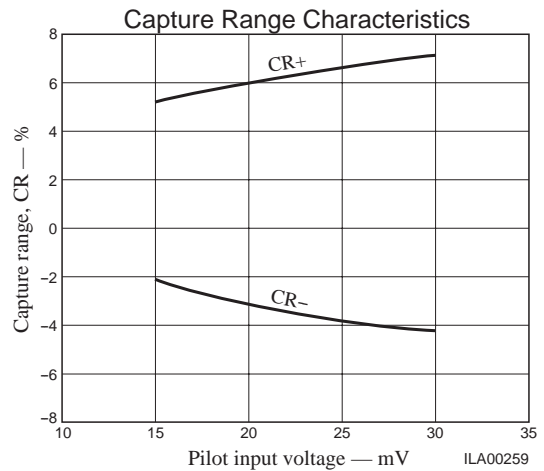
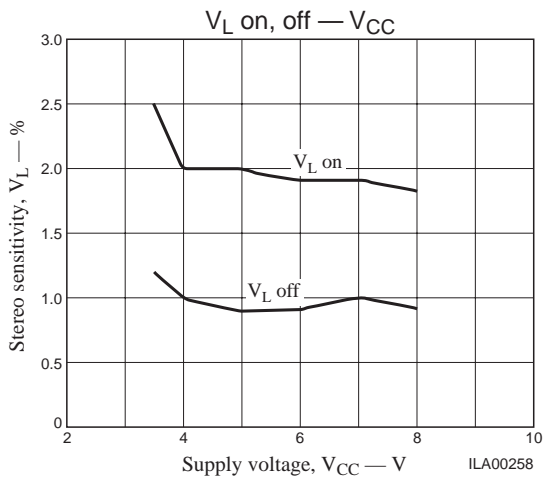

- Specifications of any and all SANYO products described or contained herein stipulate the performance, characteristics, and functions of the described products in the independent state, and are not guarantees of the performance, characteristics, and functions of the described products as mounted in the customer's products or equipment. To verify symptoms and states that cannot be evaluated in an independent device, the customer should always evaluate and test devices mounted in the customer's products or equipment.
- SANYO Electric Co., Ltd. strives to supply high-quality high-reliability products. However, any and all semiconductor products fail with some probability. It is possible that these probabilistic failures could give rise to accidents or events that could endanger human lives, that could give rise to smoke or fire, or that could cause damage to other property. When designing equipment, adopt safety measures so that these kinds of accidents or events cannot occur. Such measures include but are not limited to protective circuits and error prevention circuits for safe design, redundant design, and structural design.
- In the event that any or all SANYO products (including technical data, services) described or contained herein are controlled under any of applicable local export control laws and regulations, such products must not be exported without obtaining the export license from the authorities concerned in accordance with the above law.
- No part of this publication may be reproduced or transmitted in any form or by any means, electronic or mechanical, including photocopying and recording, or any information storage or retrieval system, or otherwise, without the prior written permission of SANYO Electric Co., Ltd.
- Any and all information described or contained herein are subject to change without notice due to product/technology improvement, etc. When designing equipment, refer to the "Delivery Specification" for the SANYO product that you intend to use.
- Information (including circuit diagrams and circuit parameters) herein is for example only; it is not guaranteed for volume production. SANYO believes information herein is accurate and reliable, but no guarantees are made or implied regarding its use or any infringements of intellectual property rights or other rights of third parties.

This catalog provides information as of December, 2000. Specifications and information herein are subject to change without notice.