



LA1845N, 1845NM

Single-Chip Home Stereo IC

Overview

The LA1845N/1845NM is designed for use in mini systems and is a single-chip tuner IC that provides electronic tuning functions using SD/IF-count technique. It incorporates a pilot canceler and an adjustment-free MUX VCO circuit, thus allows additional parts to be reduced.

Functions

- AM: RF amplifier, mixer, oscillator, IF amplifier, detector, AGC, SD, oscillator buffer, IF buffer, stereo IF output, AGC time constant switch
- FM IF: IF amplifier, quadrature detector, S-meter, SD (signal detection), S-curve detection, IF buffer output
- MPX: PLL stereo decoder, stereo display, forced monaural, VCO stop, audio muting, adjacent channel interference rejection function, pilot canceler

Features

- Integrated MPX VCO (ceramic resonators are no longer required.)
- Built-in adjacent channel interference rejection function (114 kHz, 190 kHz)
- Supports both SD and IF-count techniques
- Both FM SD sensitivity and bandwidth can be set
- Pilot canceler built in.

Package Dimensions

unit: mm

3067A-DIP24S

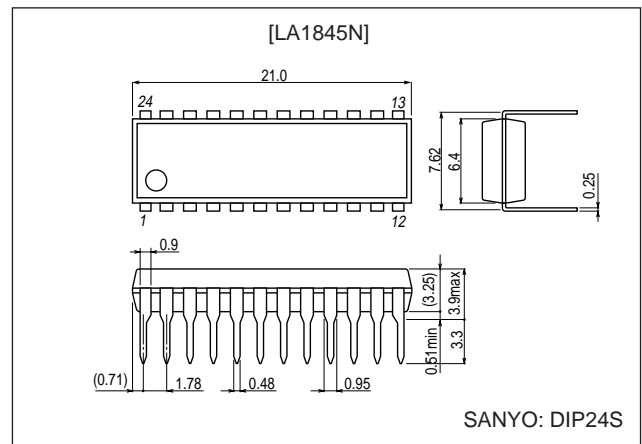

unit: mm

3112A-MFP24S

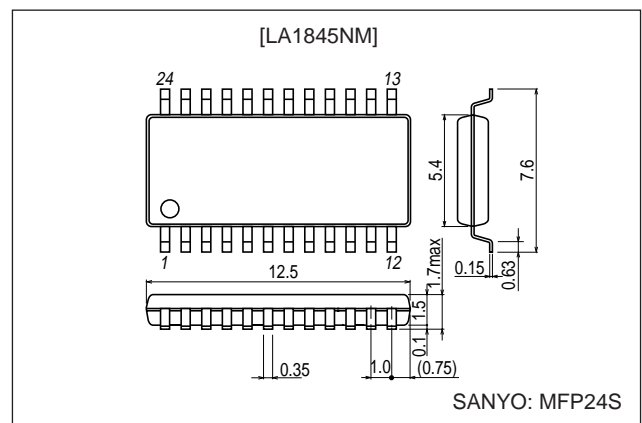

■ Any and all SANYO products described or contained herein do not have specifications that can handle applications that require extremely high levels of reliability, such as life-support systems, aircraft's control systems, or other applications whose failure can be reasonably expected to result in serious physical and/or material damage. Consult with your SANYO representative nearest you before using any SANYO products described or contained herein in such applications.

■ SANYO assumes no responsibility for equipment failures that result from using products at values that exceed, even momentarily, rated values (such as maximum ratings, operating condition ranges, or other parameters) listed in products specifications of any and all SANYO products described or contained herein.

SANYO Electric Co.,Ltd. Semiconductor Company

TOKYO OFFICE Tokyo Bldg., 1-10, 1 Chome, Ueno, Taito-ku, TOKYO, 110-8534 JAPAN

LA1845N, 1845NM

Specifications

Maximum Ratings at Ta = 25°C

Parameter	Symbol	Conditions	Ratings	Unit
Maximum supply voltage	V _{CC} max		9	V
Allowable power dissipation	Pd max	Ta ≤ 45°C	400	mW
	Pd max	Ta = 80°C (DIP)	400	mW
	Pd max	Ta = 80°C (MFP)	260	mw
Operating temperature	To _{pr}		-20 to +80	°C
Storage temperature	T _{stg}		-40 to +125	°C

Operating Conditions at Ta = 25°C

Parameter	Symbol	Conditions	Ratings	Unit
Recommended supply voltage	V _{CC}		8	V
Operating supply voltage range	V _{CCOP}	Ta = 80°C	4.3 to 8.5	V

Operating Characteristics at Ta = 25°C, V_{CC} = 8 V, in the specified test circuit.

Parameter	Symbol	Conditions	Ratings			Unit
			min	typ	max	
[FM Mono Characteristics] fc = 10.7 MHz, Vi = 100 dBμ, fm = 1 kHz, Mod = 75 kHz						
Current drain	I _{CCO-FM}	With no input signal	20	30	40	mA
Demodulator output	V _{OFM}	100 dBμ, 100% modulation, fm = 1 kHz	230	360	460	mVrms
Total harmonic distortion	THD _{FM}	100 dBμ, 100% modulation, fm = 1 kHz		0.35	1.5	%
Signal-to-noise ratio	S/N _{FM}	100 dBμ, 100% modulation, fm = 1 kHz	73	80		dB
AM rejection ratio	AMR	100 dBμ, AM 30% modulation, fm = 1 kHz	47	65		dB
3 dB sensitivity		100 dBμ, 100% modulation, fm = 1 kHz, -3 dB input		32	40	dBμ
SD sensitivity		0% modulation	38	47	56	dBμ
IF counter buffer output	V _{IFBuff-FM}	100 dBμ, the pin 13 output	80	120	160	mVrms
Mute attenuation	Mute-Att	100 dBμ, 100% modulation, fm = 1 kHz	75	85		dB
[FM Stereo Characteristics] fc = 10.7 MHz, Vi = 100 dBμ, fm = 1 kHz, L + R = 90%, Pilot = 10%						
Separation	Sep _L	Left channel modulated. The pin 16 output/the pin 17 output	30	42		dB
Stereo on level	ST _{ON}	The pilot modulation such that V7 falls under 0.7 V	1.5	3.5	5.5	%
Total harmonic distortion	THD-main	Left + right modulation. The pin 16 output.		0.45	1.5	%
Adjacent channel rejection ratio 1	Brej-3rd	fs = 113 kHz, Vs = 90%, pilot = 10% The left - right modulation, demodulated output		36		dB
Adjacent channel rejection ratio 2	Brej-5th	fs = 189 kHz, Vs = 90%, pilot = 10% The left - right modulation, demodulated output		41		dB
Carrier leak		L + R = 90%, pilot = 10% reference, pilot = 10% output	38	44		dB
[AM Characteristics] fc = 1000 kHz, Vi = 80 dBμ, fm = 1 kHz, Mod = 30%						
Current drain	I _{CCO-AM}	With no input signal	13	27	39	mA
Detector output 1	V _{OAM1}	23 dBμ, 30% modulation, fm = 1 kHz	40	80	160	mVrms
Detector output 2	V _{OAM2}	80 dBμ, 30% modulation, fm = 1 kHz	90	160	230	mVrms
Signal-to-noise ratio 1	S/N _{AM1}	23 dBμ, 30% modulation, fm = 1 kHz	17	23		dB
Signal-to-noise ratio 2	S/N _{AM2}	80 dBμ, 30% modulation, fm = 1 kHz	46	52		dB
Total harmonic distortion 1	THD _{AM1}	80 dBμ, 30% modulation, fm = 1 kHz		0.4	1.1	%
Total harmonic distortion 2	THD _{AM2}	107 dBμ, 30% modulation, fm = 1 kHz		0.5	1.3	%
SD sensitivity		0% modulation	11	20	29	dBμ
Local oscillator buffer output	V _{OSC-AM}	With no input signal	100	140	200	mVrms
IF counter buffer output	V _{IFBuff-AM}	23 dBμ	140	285	400	mVrms

LA1845N, 1845NM

Block Diagram

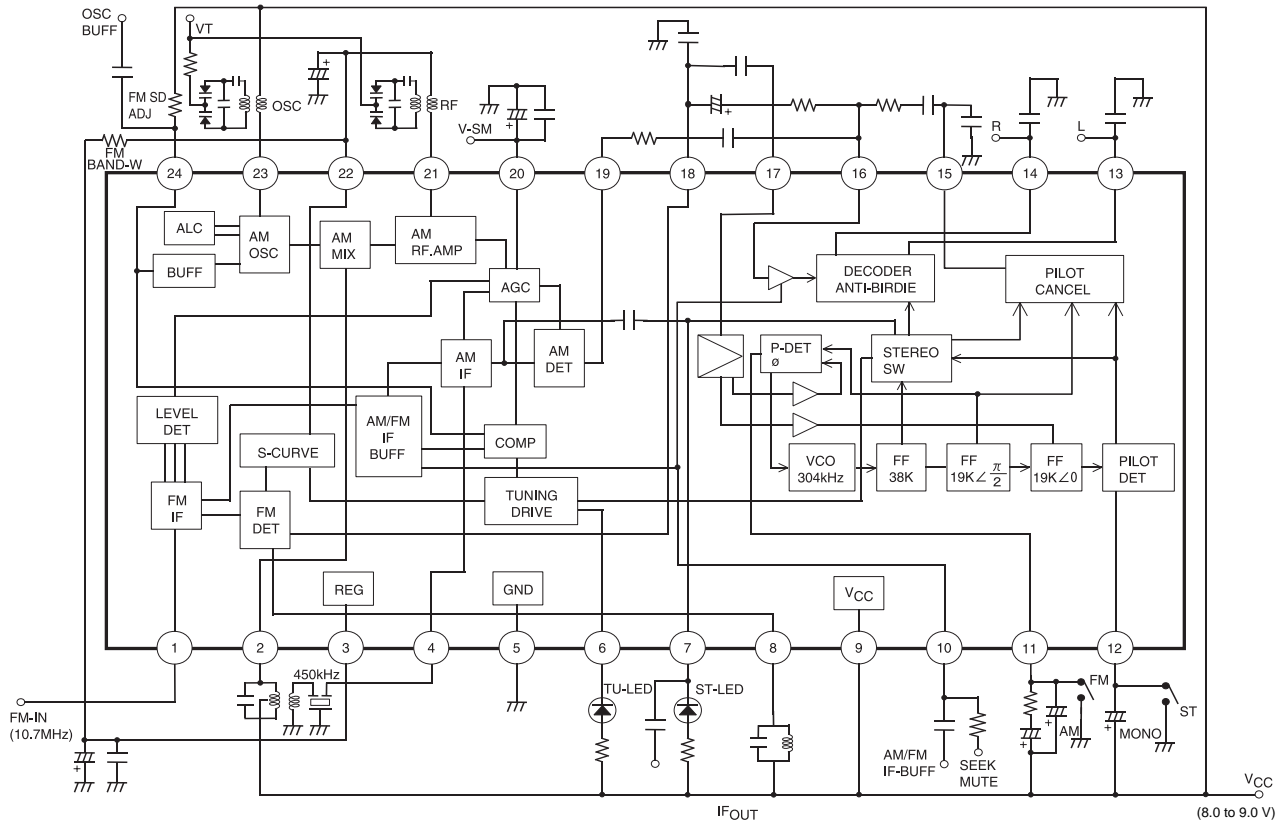

Top view

AC Test Circuit

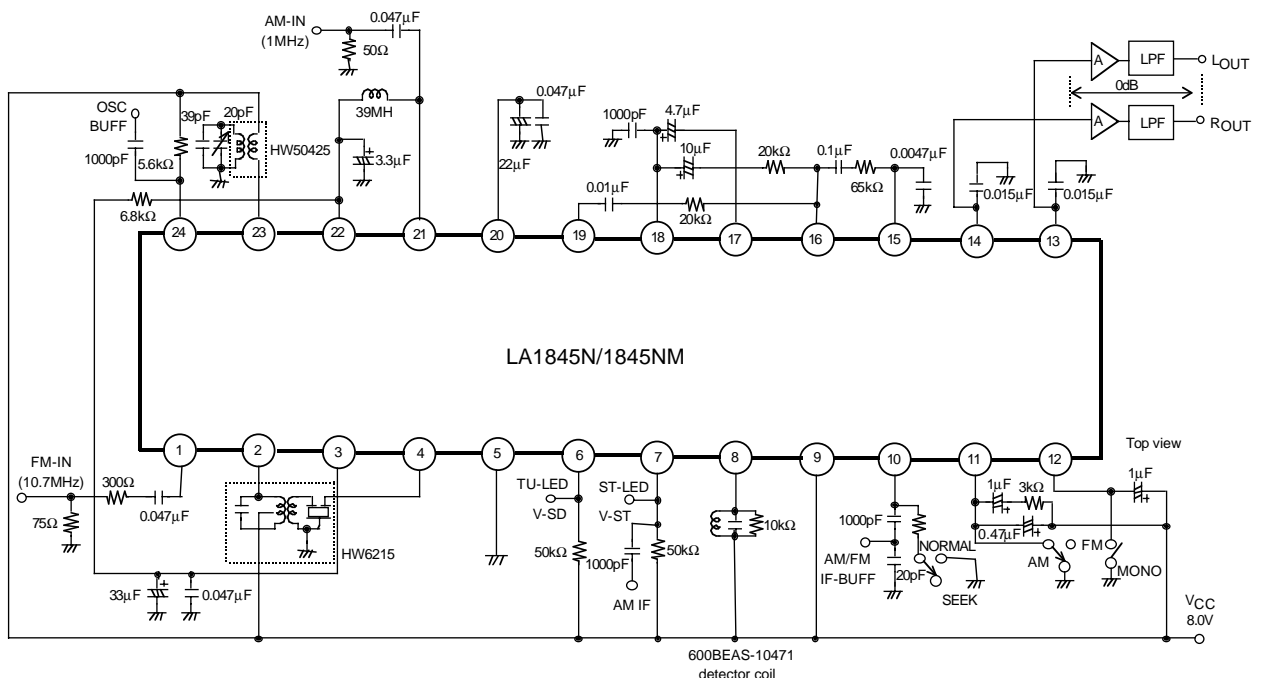

Top view

LA1845N, 1845NM

Pin Functions

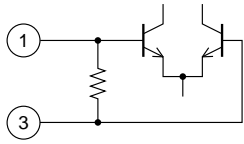
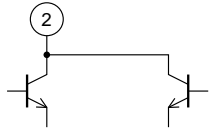
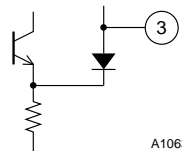
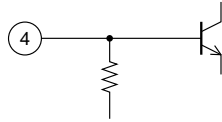
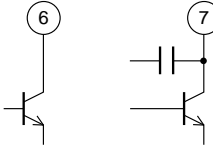
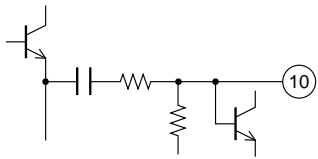
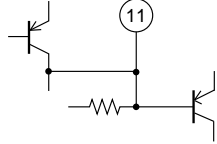
Pin No.	Pin function	Pin voltage	Notes	Equivalent circuit
1	FM IF input	Vreg	Input impedance $r_i = 330 \Omega$	 <p style="text-align: right;">A10635</p>
2	AM mixer output	V _{CC}	Connect the mixer coil between this pin and V _{CC}	 <p style="text-align: right;">A10636</p>
3	REG	2.3	Vreg = 2.3 V	 <p style="text-align: right;">A10635</p>
4	AM IF input	Vreg	Input impedance $r_i = 2 \text{ k}\Omega$	 <p style="text-align: right;">A10637</p>
5	GND	0 V		
6	TU-LED	V _{CC}	Active low	 <p style="text-align: right;">A10638</p>
7	ST-LED / AF-IF output	V _{CC}	Open collector	
8	FM detector	V _{CC}	The 600BEAS-10471 (Toko Mfg. Co., Ltd.) is recommended for detector coil.	
9	V _{CC}			
10	AM / FM IF counter output, output control switch, mute switch	0 V	$V_{10} \leq 0.5 \text{ V}$: Reception state $1.4 \text{ V} \leq V_{10} \leq 2.2 \text{ V}$: Muting on $V_{10} \geq 3.5 \text{ V}$: IF counter output and muting on	 <p style="text-align: right;">A10643</p>
11	Phase comparator low-pass filter (AM/FM switching)	V _{CC} - 1.0	The device operates in AM mode when a current of over 200 μA flows from pin.12. Limit values for the resistor: 2.7 k Ω (When V _{CC} = 7 V) 3.9 k Ω (8 V)	 <p style="text-align: right;">A10641</p>

Continued on next page.

LA1845N, 1845NM

Continued from preceding page.

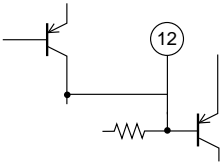
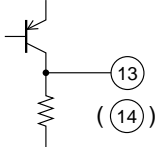
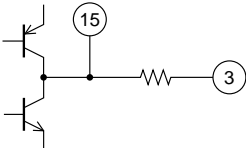
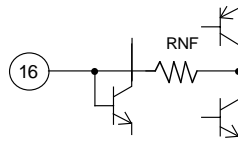
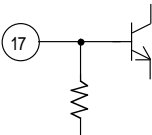
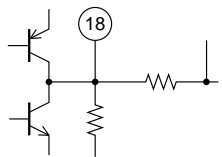
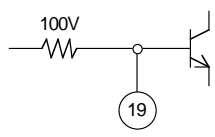
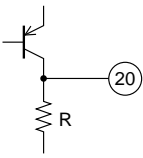
Pin No.	Pin function	Pin voltage	Notes	Equivalent circuit
12	Pilot detector low-pass filter (Forced mono) (VCO stop)	$V_{CC} - 1.0$	<p>The device is forced to monaural when a current of over $50 \mu\text{A}$ flows from this pin.</p> <p>The VCO is stopped when a current of over $200 \mu\text{A}$ flows from this pin.</p> <p>The limit values for the resistor are the same as those for pin 11.</p>	 <p style="text-align: right;">A10642</p>
13 14	L outputs R outputs	3.2 V 3.2 V	Output impedance $r_o = 3.3 \text{ k}\Omega$	 <p style="text-align: right;">A10647</p>
15	Pilot canceler output	Vreg		 <p style="text-align: right;">A10645</p>
16	Decoder input	Vreg	<p>Inverting input pin</p> <p>RNF = $20 \text{ k}\Omega$</p>	
17	PLL input	Vreg	Input impedance $r_i = 20 \text{ k}\Omega$	
18	FM demodulator output	$V_{reg} + 0.7$ (FM) $V_{reg} + 0.7$ (AM)	<p>Output impedance $r_o = 2.3 \text{ k}\Omega$</p> <p>The channel separation can be adjusted with an external capacitor connected between this pin and ground.</p>	 <p style="text-align: right;">A10649</p>
19	AM detector output	0 V (FM) 1.5 V (AM)	Output impedance $r_o = 10 \text{ k}\Omega$	 <p style="text-align: right;">A10651</p>
20	S meter, AM AGC	0.2 V (FM) 0.9 V (AM)	<p>The resistance of the built-in resistor R is $13.9 \text{ k}\Omega$</p> <p>The SD response during seek operation is determined with the external capacitor connected to this pin.</p>	 <p style="text-align: right;">A10651</p>

Continued on next page.

LA1845N, 1845NM

Continued from preceding page.

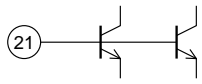
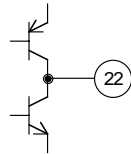
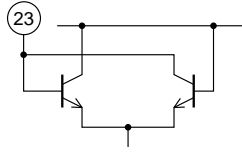
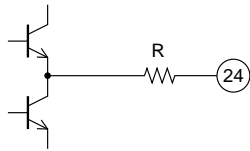
Pin No.	Pin function	Pin voltage	Notes	Equivalent circuit
21	AM RF input	Vreg	Must be used at the same potential as pin 22	 <p style="text-align: right;">A10653</p>
22	AFC	Vreg	The FM SD bandwidth can be adjusted with the external resistor connected between this pin and pin 3 (Vreg)	
23	OSC	Vcc	Connect the oscillator coil between this pin and pin 9 (Vcc) Note: Impedance of the secondary oscillator coil must be 5 kΩ or higher.	 <p style="text-align: right;">A10655</p>
24	Oscillator buffer output, FM SD sensitivity adjustment	Vcc - 1.4	The FM SD sensitivity can be adjusted with an external resistor connected to this pin. Output impedance $r_o = 200 \Omega$ Note: Resistance of the external resistor connected to the pin 24 must be 3.3 kΩ or higher.	 <p style="text-align: right;">A10656</p>

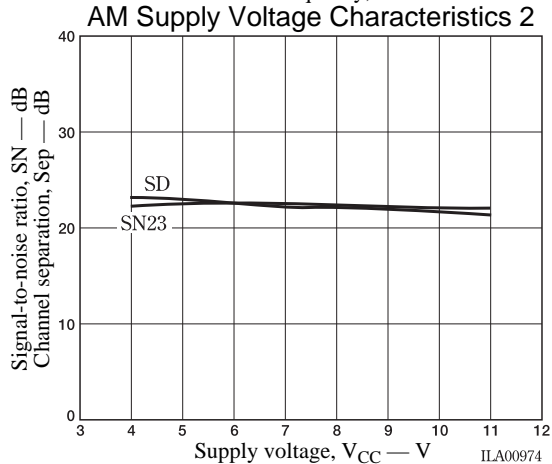
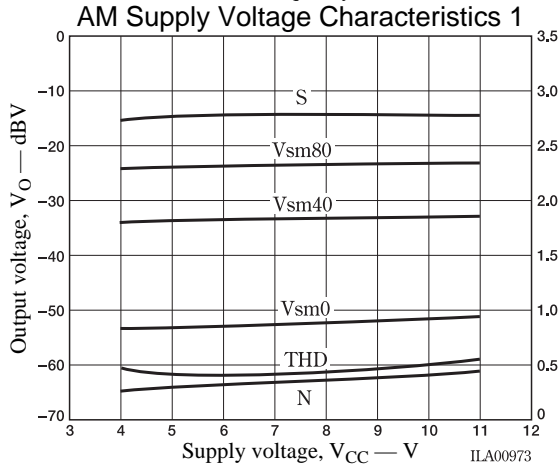
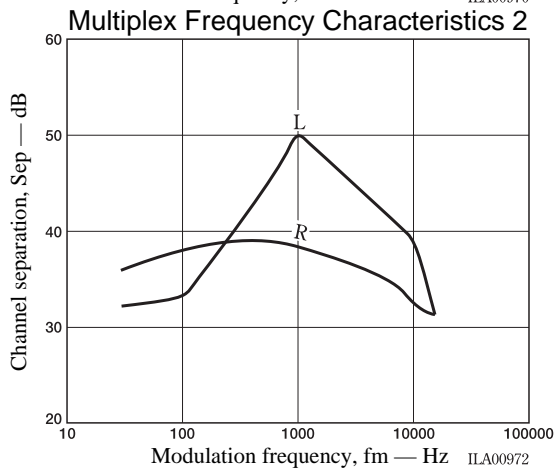
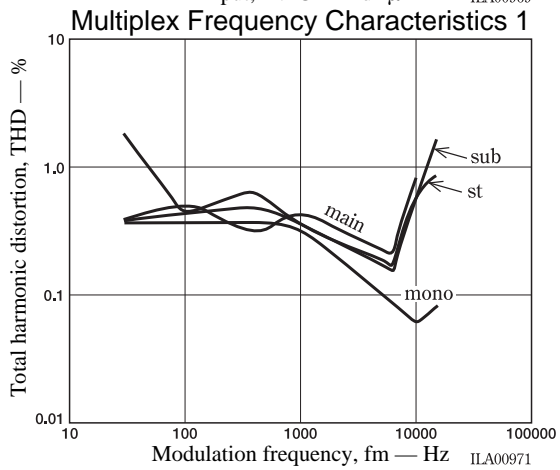
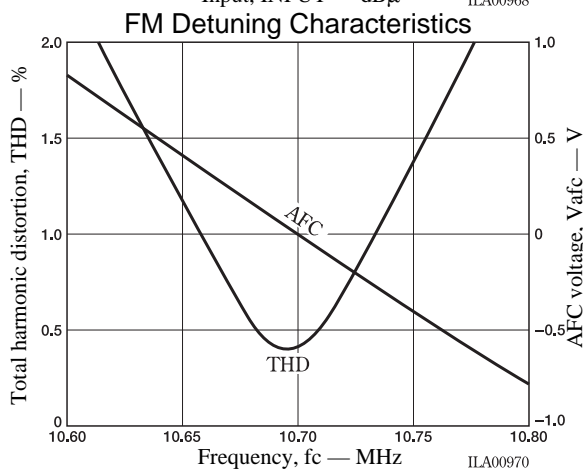
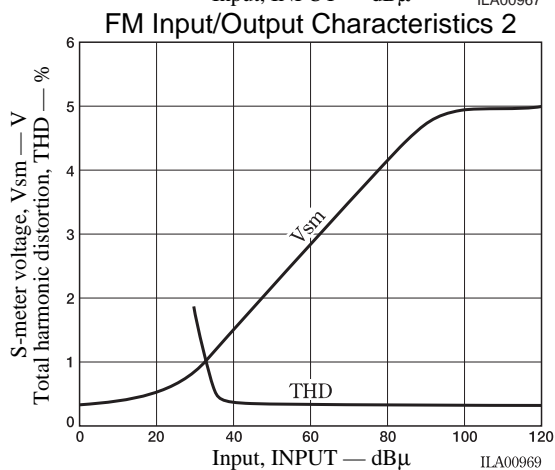
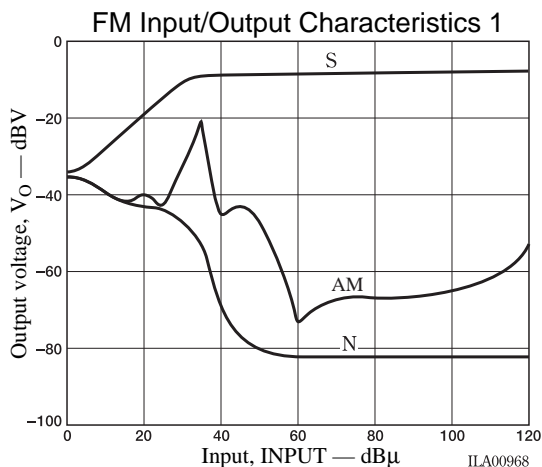
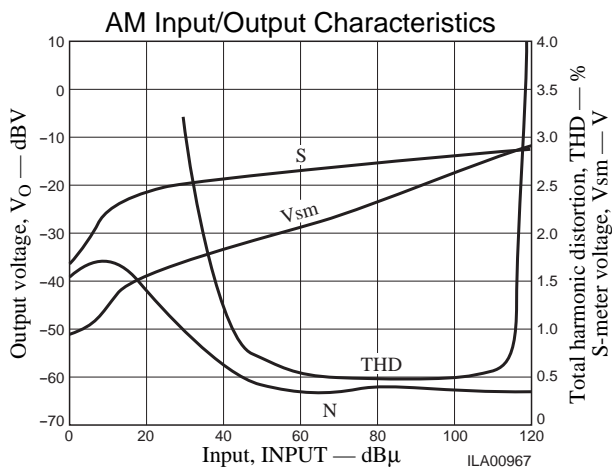

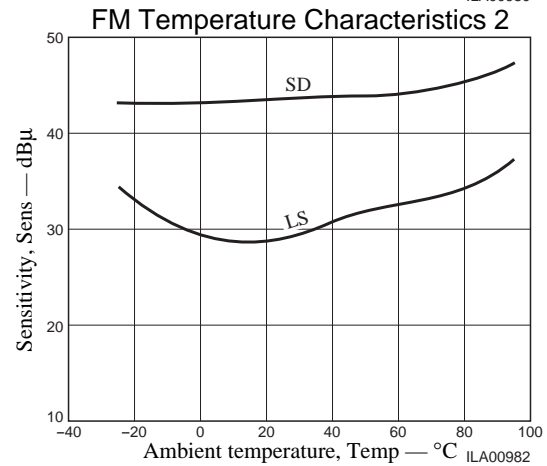
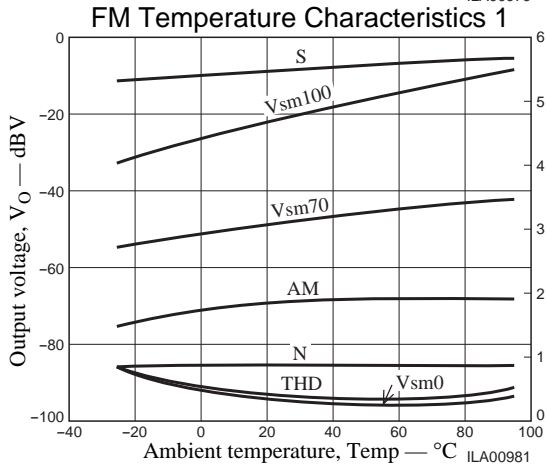
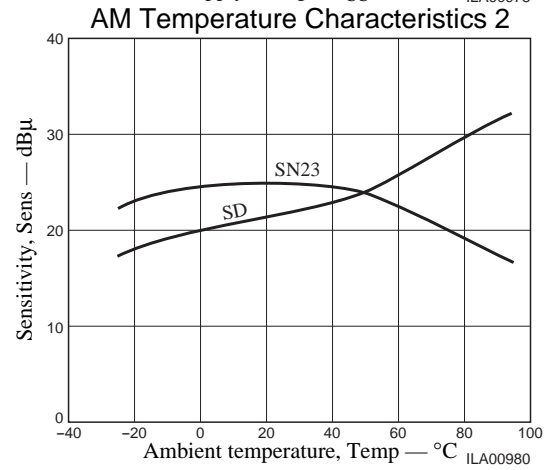
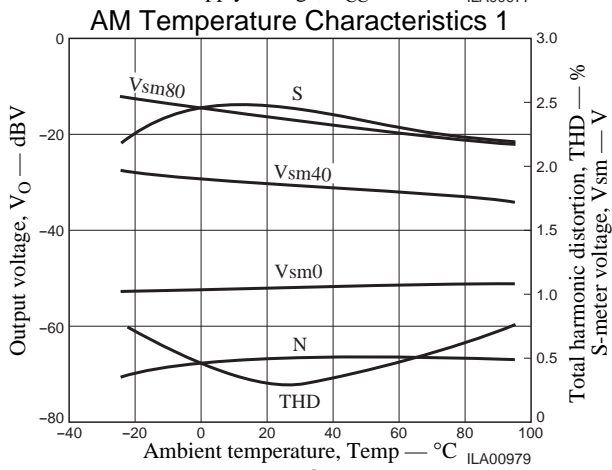
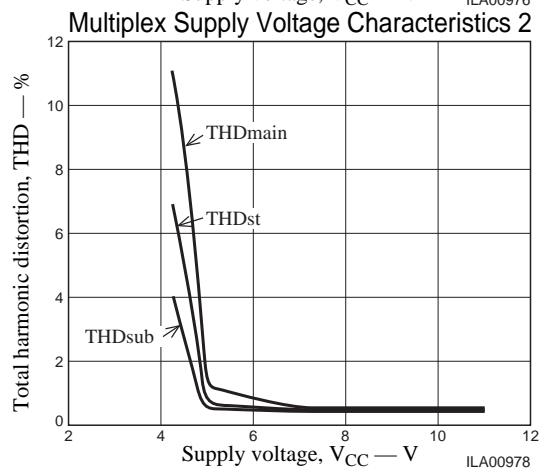
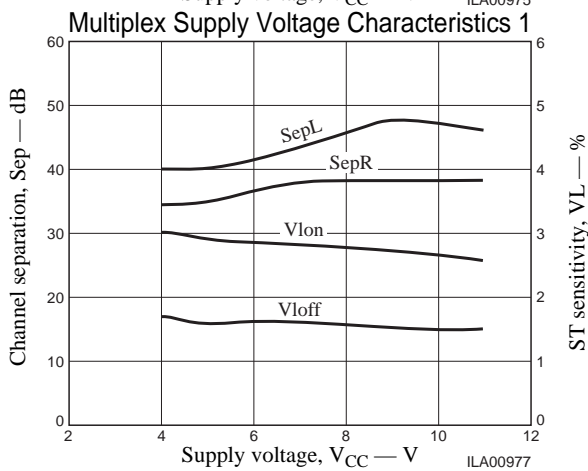
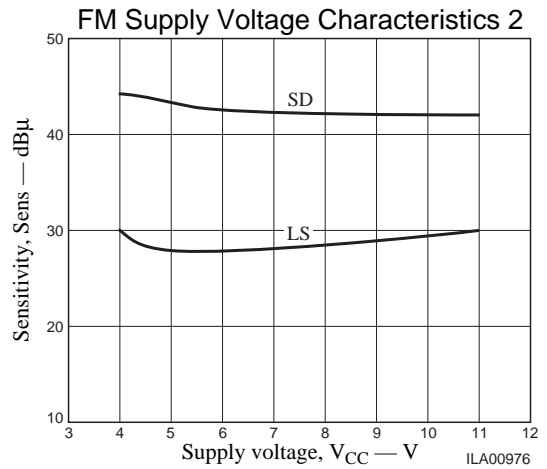
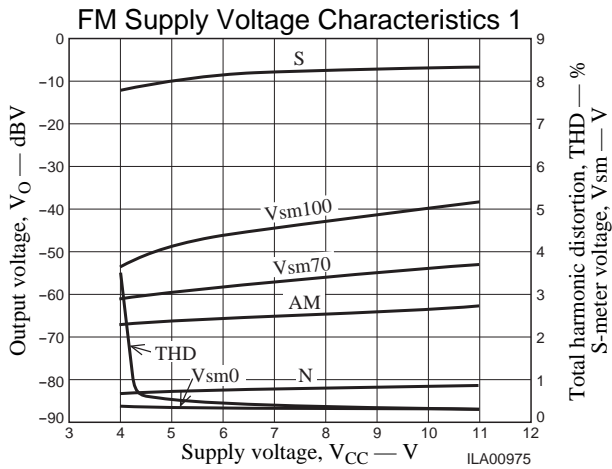

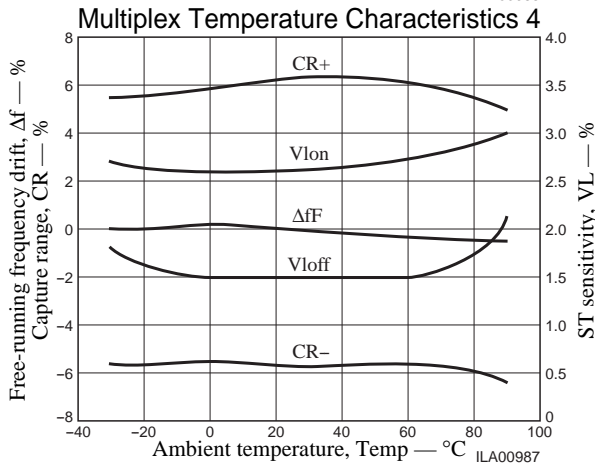
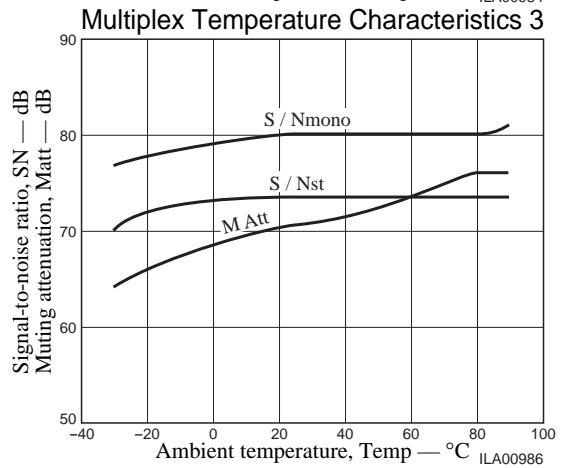
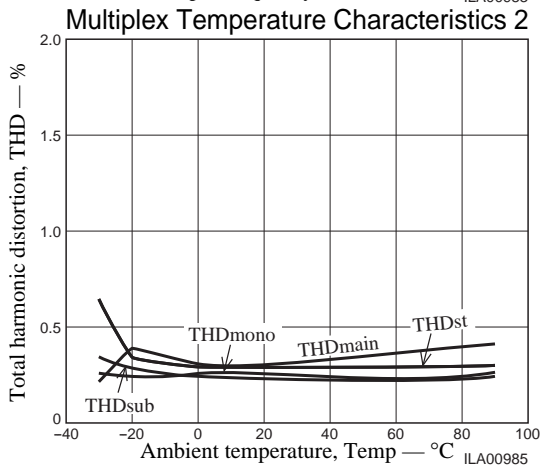
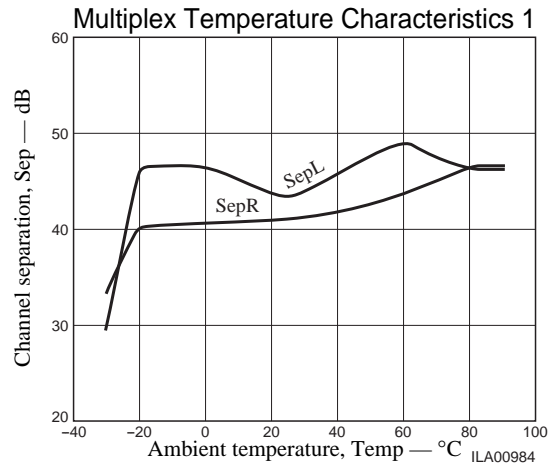
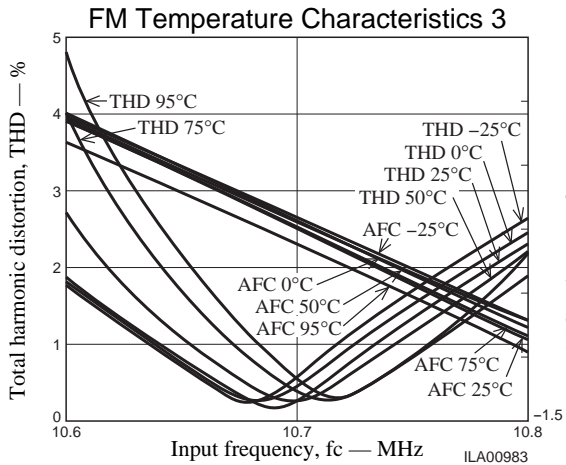

- Specifications of any and all SANYO products described or contained herein stipulate the performance, characteristics, and functions of the described products in the independent state, and are not guarantees of the performance, characteristics, and functions of the described products as mounted in the customer's products or equipment. To verify symptoms and states that cannot be evaluated in an independent device, the customer should always evaluate and test devices mounted in the customer's products or equipment.
- SANYO Electric Co., Ltd. strives to supply high-quality high-reliability products. However, any and all semiconductor products fail with some probability. It is possible that these probabilistic failures could give rise to accidents or events that could endanger human lives, that could give rise to smoke or fire, or that could cause damage to other property. When designing equipment, adopt safety measures so that these kinds of accidents or events cannot occur. Such measures include but are not limited to protective circuits and error prevention circuits for safe design, redundant design, and structural design.
- In the event that any or all SANYO products (including technical data, services) described or contained herein are controlled under any of applicable local export control laws and regulations, such products must not be exported without obtaining the export license from the authorities concerned in accordance with the above law.
- No part of this publication may be reproduced or transmitted in any form or by any means, electronic or mechanical, including photocopying and recording, or any information storage or retrieval system, or otherwise, without the prior written permission of SANYO Electric Co., Ltd.
- Any and all information described or contained herein are subject to change without notice due to product/technology improvement, etc. When designing equipment, refer to the "Delivery Specification" for the SANYO product that you intend to use.
- Information (including circuit diagrams and circuit parameters) herein is for example only; it is not guaranteed for volume production. SANYO believes information herein is accurate and reliable, but no guarantees are made or implied regarding its use or any infringements of intellectual property rights or other rights of third parties.

This catalog provides information as of September, 2002. Specifications and information herein are subject to change without notice.