



LA9242M

Analog Signal Processor (ASP) for CD Players

Overview

The LA9242M is an analog signal processing and servo control bipolar IC designed for use in compact disc players ; a compact disc player can be configured by combining this IC with a CD-DSP such as the LC78922E and LC78620E, with a small number of additional components required. In addition, this IC allows CD-RW disk playback due to the on-chip gain switching function.

Functions

I/V amplifier, RF amplifier (with AGC), SLC, APC, FE, TE (with VCA and auto-balance function), focus servo amplifier (with offset cancellation function), spindle servo amplifier (with gain switching function), sled servo amplifier (with off function), focus detection (DRF, FZD), track detection (HFL, TES), defect detection, and shock detection.

Features

- The following automatic adjustment functions are built in.
 - Focus offset auto cancel : FE (pin 20)
 - Tracking offset auto cancel : TE (pin 7).
 - EF balance auto adjustment.
 - RF level AGC function.
 - Tracking servo gain RF level following function.
- Focus search smoothing setting pin : FSC (pin 46)
- EF balance adjustment variable range setting pin : (pin 47)
- Focus search mode switching pin : (pin 55)
- Play disc (Normal, CD-RW) mode switching pin : (pin 38)

Package Dimensions

unit:mm

3159A-QFP64E

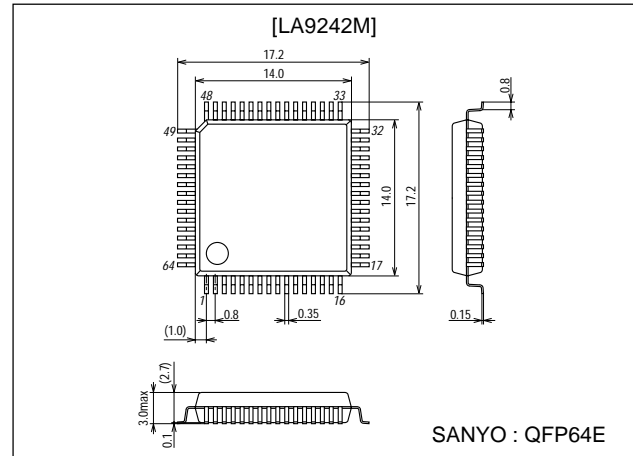

- Any and all SANYO products described or contained herein do not have specifications that can handle applications that require extremely high levels of reliability, such as life-support systems, aircraft's control systems, or other applications whose failure can be reasonably expected to result in serious physical and/or material damage. Consult with your SANYO representative nearest you before using any SANYO products described or contained herein in such applications.
- SANYO assumes no responsibility for equipment failures that result from using products at values that exceed, even momentarily, rated values (such as maximum ratings, operating condition ranges, or other parameters) listed in products specifications of any and all SANYO products described or contained herein.

LA9242M

Specifications

Maximum Ratings at Ta = 25°C, Pins 22, 45=GND

Parameter	Symbol	Conditions	Ratings	Unit
Maximum supply voltage	V _{CC} max	Pin 56, 64	7	V
Allowable power dissipation	Pd max		350	mW
Operating temperature	Topr		-25 to +75	°C
Storage temperature	Tstg		-40 to +150	°C

Operating Conditions at Pins 22, 45=GND

Parameter	Symbol	Conditions	Ratings	Unit
Recommended supply voltage	V _{CC}		5	V
Allowable operating supply voltage	V _{CC} op		3.2 to 5.5	V

Operating Supply Voltage at Limit of Operating Temperature at Pins 22, 45=GND

Parameter	Symbol	Conditions	Ratings	Unit
Operating temperature	Topr2		-10 to +75	°C
Allowable operating supply voltage	V _{CC} op2		3.0 to 5.5	V

Operating Characteristics at Ta=25°C, Pins 22, 45=GND, V_{CC} (pins 56, 64)=5V

Parameter	Symbol	Conditions	Ratings			Unit
			min	typ	max	
Current drain	I _{CCO}	V _{CC} 1 (pin 64)+V _{CC} 2 (pin 56)	24	34	44	mA
Reference voltage	V _{REF}	VR	2.3	2.5	2.7	V
[Interface]						
CE-Vth	CEvth	CE		0.8		V
CL-Vth	CLvth	CL		0.8		V
DAT-Vth	DATvth	DAT		0.8		V
Maximum CL frequency	CL max		500			kHz
[RF amplifier]						
RFSM no signal voltage	RFSMo		1.35	1.60	1.85	V
RF amplifier (Normal)	RFSMgmin1	FIN1, FIN2 : 1MΩ-input, PH1=4V, freq=200kHz, RFSM, RW=H	-12.0	-10.5	-9.0	dB
RF amplifier (CD-RW)	RFSMgmin2	FIN1, FIN2 : 1MΩ-input, PH1=4V, freq=200kHz, RFSM, RW=L	0	1.5	3.0	dB
[Focus amplifier]						
FDO gain (Normal)	FDg1	FIN2 : 1MΩ-input, FDO, RW=H	3.5	5.0	6.5	dB
FDO gain (CD-RW)	FDg2	FIN2 : 1MΩ-input, FDO, RW=L	15.5	17.0	18.5	dB
FDO offset (Normal)	FDost1	Difference from reference voltage, servo on, RW=H	-170	0	+170	mV
FDO offset (CD-RW)	FDost2	Difference from reference voltage, servo on, RW=L	-190	0	+190	mV
Off time offset (Normal)	FDofost1	Difference from reference voltage, servo off, RW=H	-40	0	+40	mV
Off time offset (CD-RW)	FDofost2	Difference from reference voltage, servo off, RW=L	-40	0	+40	mV
Offset adjustment step	FDstep	FE		19		mV
F search voltage H1	FSmax1	FDO, FSS=GND		0.8		V
F search voltage L1	FSmin1	FDO, FSS=GND		-0.8		V
F search voltage H2	FSmax2	FDO, FSS=V _{CC}		0.8		V
F search voltage L2	FSmin2	FDO, FSS=V _{CC}		0		V
[Tracking amplifier]						
TE gain MAX (Normal)	TEgmax1	f=10kHz, E : 1MΩ-input, PH1=4V, RW=H	6.0	7.5	9.0	dB
TE gain MAX (CD-RW)	TEgmax2	f=10kHz, E : 1MΩ-input, PH1=4V, RW=L	18.0	19.5	21.0	dB
TE gain MIN (Normal)	TEgmin1	f=10kHz, E : 1MΩ-input, PH1=1V, RW=H	-0.5	+1.8	+4.0	dB
TE gain MIN (CD-RW)	TEgmin2	f=10kHz, E : 1MΩ-input, PH1=1V, RW=L	11.5	13.8	16.0	dB
TE-3dB (Normal)	TEfc1	E : 1MΩ-input, RW=H		80		kHz
TE-3dB (CD-RW)	TEfc2	E : 1MΩ-input, RW=L		80		kHz
TO gain	TOg	TH → TO gain, THLD mode	4.0	6.0	8.0	dB
TGL offset (Normal)	TGLost1	Servo on, TGL=H, TO, RW=H	-250	0	+250	mV
TGL offset (CD-RW)	TGLost2	Servo on, TGL=H, TO, RW=L	-450	0	+450	mV
TGH offset (Normal)	TGHost1	TGL=L, difference from TGL offset, TO, RW=H	-50	0	+50	mV
TGH offset (CD-RW)	TGHost2	TGL=L, difference from TGL offset, TO, RW=L	-50	0	+50	mV
THLD offset (Normal)	THLDost1	THLD mode, difference from TGL offset, TO, RW=H	-50	0	+50	mV
THLD offset (CD-RW)	THLDost2	THLD mode, difference from TGL offset, TO, RW=L	-50	0	+50	mV
Off 1 offset	OFF1ost	TOFF=H	-50	0	+50	mV
Off 2 offset	OFF2ost	TOFF2 off (IF)	-50	0	+50	mV

Continued on next page.

LA9242M

Continued from preceding page.

Parameter	Symbol	Conditions	Ratings			Unit
			min	typ	max	
[Tracking amplifier]						
Offset adjustment step	TEstep	TE		70		mV
Balance range H	BAL-H	Δ Gain E/F input, TB=5V, TBC=open		3.5		dB
Balance range L	BAL-L	Δ Gain E/F input, TB=0V, TBC=open		-3.5		dB
TOFF-VTH	TOFFvth		1.0	2.5	3.0	V
TGL-VTH	TGLvth		1.0	2.5	3.0	V
[PH]						
No signal voltage	PHo	Difference from RFSM	-0.85	-0.65	-0.45	V
[BH]						
No signal voltage	BHo	Difference from RFSM	0.45	0.65	0.85	V
[DRF]						
Detection voltage	DRFvth	Difference from VR at RFSM	-0.4	-0.2	0	V
Output voltage H	DRF-H		4.5	4.9		V
Output voltage L	DRF-L			0	0.5	V
[FZD]						
Detection voltage 1	FZD1	FE, difference from VR	0	+0.2		V
Detection voltage 2	FZD2	FE, difference from VR		0		V
[HFL]						
Detection voltage	HFLvth	Difference from VR at RFSM	-0.55	-0.4	-0.25	V
Output voltage H	HFL-H		4.5	4.9		V
Output voltage L	HFL-L			0	0.5	V
[TES]						
Detection voltage LH	TES-LH	TESI, difference from VR	-0.15	-0.10	-0.05	V
Detection voltage HL	TES-HL	TESI, difference from VR	0.05	0.10	0.15	V
Output voltage H	TES-H		4.5	4.9		V
Output voltage L	TES-L			0	0.5	V
[JP]						
Output voltage H	JP-H	Difference from JP ⁺ =0V, JP ⁻ =0V at JP ⁺ =0V, JP ⁻ =5V, TO	0.35	0.5	0.65	V
Output voltage L	JP-L	Difference from JP ⁺ =0V, JP ⁻ =0V at JP ⁺ =5V, JP ⁻ =0V, TO	-0.65	-0.5	-0.35	V
[Spindle amplifier]						
Offset 12	SPD12ost	Difference from VR at SPD, 12cm mode	-40	0	+40	mV
Offset 8	SPD8ost	Difference from VR at SPD, 8cm mode	-40	0	+40	mV
Offset off	SPDof	Difference from VR at SPD, OFF mode	-30	0	+30	mV
Output voltage H12	SPD-H12	Difference from offset-12, 12cm mode, CV ⁺ =5V, CV ⁻ =0V	0.75	1.0	1.25	V
Output voltage L12	SPD-L12	Difference from offset-12, 12cm mode, CV ⁺ =0V, CV ⁻ =5V	-1.25	-1.0	-0.75	V
Output voltage H8	SPD-H8	Difference from offset-8, 8cm mode, CV ⁺ =5V, CV ⁻ =0V	0.35	0.5	0.65	V
[Sled amplifier]						
SLEQ offset	SLEQost	Difference from TO at SLEQ	-30	0	+30	mV
Offset SLD	SLDost	SLEQ=VR, difference from VR	-100	0	+100	mV
Offset off	SLDof	Off mode	-40	0	+40	mV
Disc switching	RWvth	RW	1.5	2.0	2.7	V
[SLC]						
No signal voltage	SLCo	SLC	2.25	2.5	2.75	V
[Shock]						
No signal voltage	SClo	SCI, difference from VR	-40	0	+40	mV
Detection voltage H	SClvthH	SCI, difference from VR	60	100	140	mV
Detection voltage L	SClvthL	SCI, difference from VR	-140	-100	-60	mV
[DEF]						
Detection voltage	DEFvth	Difference between LF2 voltage when RFSM=3.5V and DEF is detected and LF2 voltage when RFSM=3.5V	0.20	0.35	0.50	V
Output voltage H	DEF-H		4.5	4.9		V
Output voltage L	DEF-L			0	0.5	V
[APC]						
Reference voltage	LDS	LDS voltage at which LDD=3V	160	190	220	mV
Off voltage	LDDoff	LDD	3.9	4.3	4.6	V

LA9242M

Pin Functions

Pin No.	Symbol	Contents
1	FIN2	Pickup photodiode connection pin. Added to FIN1 pin to generate the RF signal, subtracted from FIN1 pin to generate the FE signal.
2	FIN1	Pickup photodiode connection pin.
3	E	Pickup photodiode connection pin. Subtracted from pin F to generate the TE signal.
4	F	Pickup photodiode connection pin.
5	TB	TE signal DC component input pin.
6	TE ⁻	Pin which connects the TE signal gain setting resistor between this pin and TE pin.
7	TE	TE signal output pin.
8	TESI	TES (Track Error Sense) comparator input pin. The TE signal is input through a bandpass filter.
9	SCI	Shock detection input pin.
10	TH	Tracking gain time constant setting pin.
11	TA	TA amplifier output pin.
12	TD ⁻	Pin for configuring the tracking phase compensation constant between the TD and VR pins.
13	TD	Tracking phase compensation setting pin.
14	JP	Tracking jump signal (kick pulse) amplitude setting pin.
15	TO	Tracking control signal output pin.
16	FD	Focusing control signal output pin.
17	FD ⁻	Pin for configuring the focusing phase compensation constant between the FD and FA pins.
18	FA	Pin for configuring the focusing phase compensation constant between the FD ⁻ and FA ⁻ pins.
19	FA ⁻	Pin for configuring the focusing phase compensation constant between the FA and FE pins.
20	FE	FE signal output pin.
21	FE ⁻	Pin which connects the FE signal gain setting resistor between this pin and FE pin.
22	AGND	Analog signal GND.
23	NC	No connection
24	SP	CV ⁺ and CV ⁻ pins input signal single-end output.
25	SPG	12-cm spindle mode gain setting resistor connection pin.
26	SP ⁻	Spindle phase compensation constant connection pin, along with the SPD pin.
27	SPD	Spindle control signal output pin.
28	SLEQ	Sled phase compensation constant connection pin.
29	SLD	Sled control signal output pin.
30	SL ⁻	Input pin for sled movement signal from microcontroller.
31	SL ⁺	Input pin for sled movement signal from microcontroller.
32	JP ⁻	Input pin for tracking jump signal from DSP.
33	JP ⁺	Input pin for tracking jump signal from DSP.
34	TGL	Input pin for tracking gain control signal from DSP. Gain is low when TGL is high.
35	TOFF	Input pin for tracking off control signal from DSP. Tracking servo is off when TOFF is high.
36	TES	Output pin for TES signal to DSP.
37	HFL	The High Frequency Level is used to determine whether the main beam is positioned over a bit or over the mirrored surface.
38	RW	Input pin for gain setting, according to CD or RW disc. Gain is high (RW disc mode), when RW is low.
39	CV ⁻	Input pin for CLV error signal from DSP.
40	CV ⁺	Input pin for CLV error signal from DSP.
41	RFSM	RF output pin.
42	RFS ⁻	RF gain setting and EFM signal 3T compensation constant setting pin, along with the RFSM pin.
43	SLC	Slice Level Control is an output pin that controls the data slice level used by the DSP for the RF waveform.
44	SLI	Input pin used by DSP for controlling the data slice level.
45	DGND	Digital system GND pin.
46	FSC	Focus search smoothing capacitor output pin.
47	TBC	Tracking Balance Control ; EF balance adjustment variable range setting pin.
48	NC	No connection
49	DEF	Disc defect detection output pin.
50	CLK	Reference clock input pin. 4.23MHz signal from the DSP is input.
51	CL	Microprocessor command clock input pin.
52	DAT	Microprocessor command data input pin.
53	CE	Microprocessor command chip enable input pin.

Continued on next page.

LA9242M

Continued from preceding page.

Pin No.	Symbol	Contents
54	DRF	RF level detection output (Detect RF).
55	FSS	Focus Search Select ; focus search mode (\pm search/+search vs. the reference voltage) switching pin.
56	V _{CC2}	Servo system and digital system V _{CC} pin.
57	REFI	By-pass capacitor connection pin for reference voltage.
58	VR	Reference voltage output pin.
59	LF2	Disc detect detection time constant setting pin.
60	PH1	RF signal peak hold capacitor connection pin.
61	BH1	RF signal bottom hold capacitor connection pin.
62	LDD	APC circuit output pin.
63	LDS	APC circuit input pin.
64	V _{CC1}	RF system V _{CC} pin.

Block Diagram

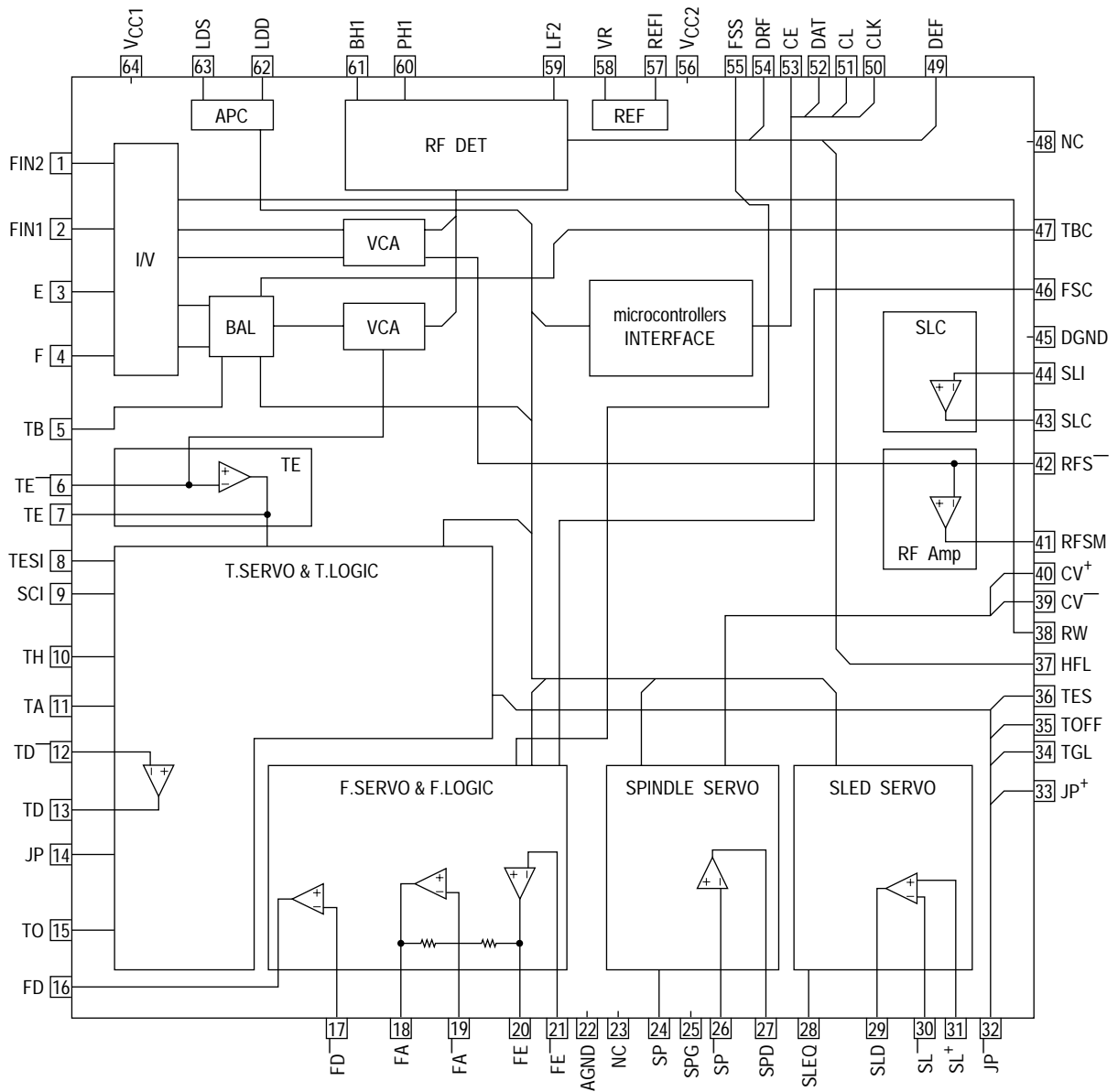

LA9242M

Test Circuit

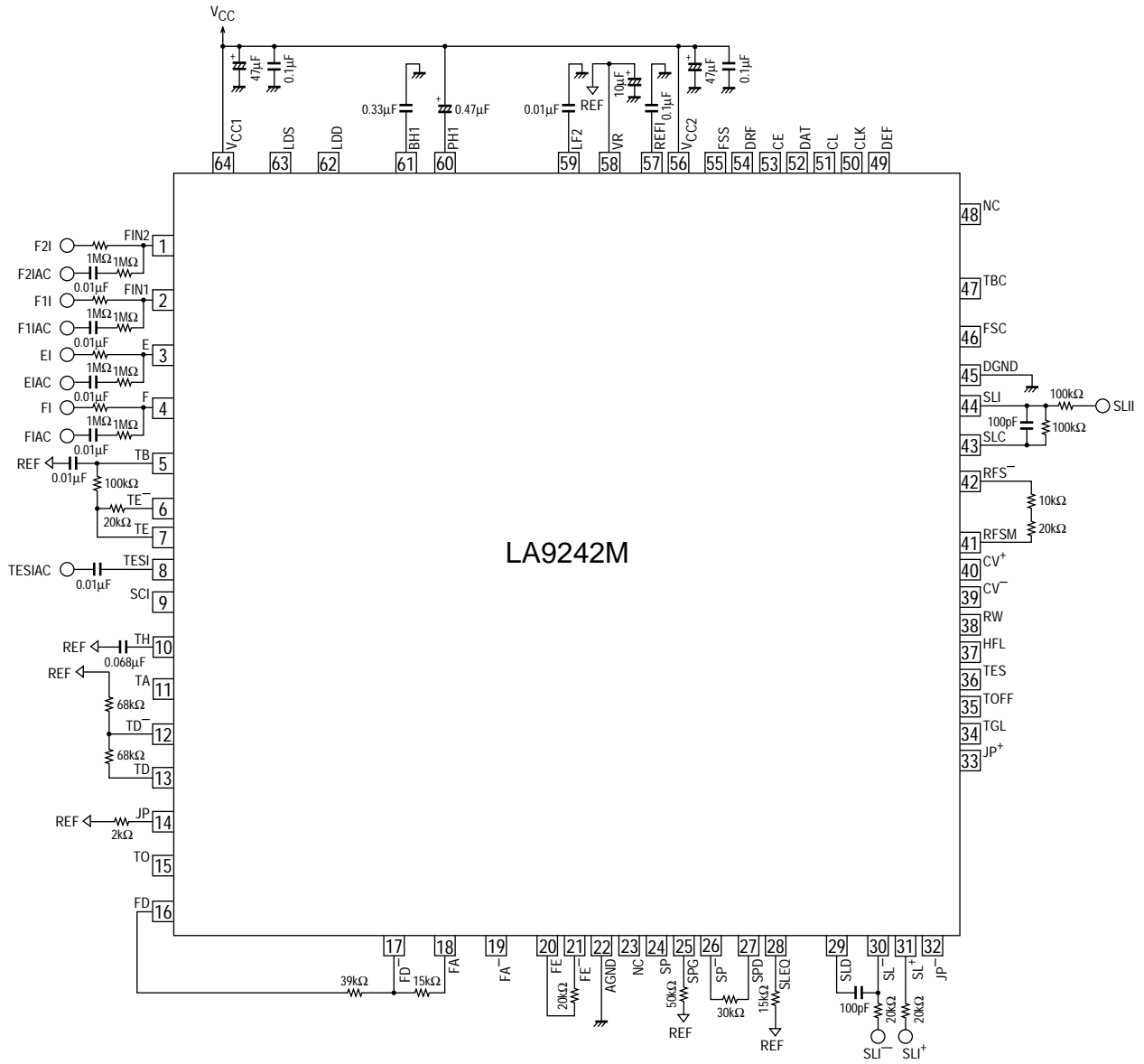

Description of Operation

1. APC (auto laser power control)

This circuit controls the pickup laser power. The laser is turned on and off by commands from the microcontroller.

2. RF amplifier (eye pattern output)

The pickup photodiode output current (A+C) is input to FIN2 (pin 1), and (B+D) is input to FIN1 (pin 2). The current that is input is converted to the voltage, passes through the AGC circuit, and is then output from the RFSM amplifier output RFSM (pin 41). The internal AGC circuit has a variable range of $\pm 3\text{dB}$, and the time constant can be changed through the external capacitor connected to PH1 (pin 60). In addition, this circuit also controls the bottom level of the EFM signal (RFSM output), and the response can be changed through the external capacitor connected to BH1 (pin 61). The center gain setting for the AGC variable range is set by the resistance between RFSM (pin 41) and RFS⁻ (pin 42); if necessary, this resistance is also used for 3T compensation for the EFM signal. If RW disc is detected, input signal gain is set high by RW (pin 38) which accepts Low from the DSP.

3. SLC (slice level control)

The SLC sets the duty ratio for the EFM signal that is input to the DSP to 50%. The DC level determined by integrating the EFMO signal output from the DSP to determine the duty factor.

4. Focus servo

The focus error signal is derived by detecting the difference between (A+C) and (B+D), which is $(B+D) - (A+C)$, and is then output from FE (pin 20). The focus error signal gain is set by the resistance between FE (pin 20) and FE⁻ (pin 21). If RW disc is detected, input signal gain is set high by RW (pin 38) which accepts Low from the DSP. Offset cancellation is performed by the FE amplifier. "Offset cancellation" cancels the offset for the IC's internal IV amplifier, etc. Adjustment is initiated by the FOCUS-OFFSET ADJUST START command, and terminates after about 30 ms. The FOCUS-OFFSET ADJUST OFF command is used to return to the state before offset cancellation. The FA amplifier is the pickup phase compensation amplifier, and the equalizer curve is set by the external capacitor and resistance. Furthermore, this amplifier has a mute function which is applied when V_{CC} is turned on, when the F-SERVO OFF command is sent, and during F-SEARCH. In order to turn the focus servo on, send either the LASER ON command or the F-SERVO ON command.

The FD amplifier has a phase compensation circuit, a focus search signal composition function and is completed in about 560 ms. Focus search is initiated by the F-SEARCH command, and a ramp waveform is generated by the internal clock. This waveform is used for focus detection (focus zero cross) with the focus error signal and then turn the focus servo on. The ramp waveform amplitude is set by the resistance between FD (pin 16) and FD⁻ (pin 17). FSC (pin 46) is for smoothing the focus search ramp waveforms, and a capacitor is connected between FSC and REF. FSS (pin 55) is the focus search mode switching pin. If FSS is shorted with V_{CC}, the "+ search" is set; if FSS is left open or is shorted with GND, the "± search" is set.

5. Tracking servo

The pickup photodiode output current is input to E (pin 3) and F (pin 4). The current that is input is converted to the voltage, passes through the balance adjustment VCA circuit and then the VCA circuit that follows the gain in the RFAGC circuit, and is then output from TE (pin 7). The tracking error gain is set by the resistance between TE⁻ (pin 6) and TE (pin 7). If RW disc is detected, input signal gain is set high by RW (pin 38) which accepts Low from the DSP.

Offset cancellation is performed by the TE amplifier. Offset cancellation terminates after about 30 ms. The TRACK-OFFSET ADJUST OFF command is used to return to the state before the offset.

The TH amplifier alters the servo response characteristics according to the THLD signal, etc., generated internally after detection of the TGL signal from the DSP or the JP signal. When a defect is detected, the THLD mode goes into effect internally. To avoid this, short DEF (pin 49) to L=GND. By inserting an external bandpass filter to remove the shock component from the tracking error signal at SCI (pin 9), the gain is automatically boosted when a defect is detected.

The TA output (pin 11) has a built-in resistance to allow configuration of a low-pass filter.

The TD amplifier performs servo loop phase compensation; the characteristics are set by external CR. Furthermore, this amplifier has a mute function, which is applied when V_{CC} is turned on or the TRACK-SERVO OFF command is issued. The muting function is released by the TRACK-SERVO ON command.

The TOFF amplifier that is positioned immediately after TD (pin 13) functions to turn off the servo in response to the TOFF signal from the DSP.

The TO amplifier has a JP pulse composition function. The JP pulse is set by JP (pin 14). (THLD detection is performed internally.)

6. Sled servo

The response characteristics are set by SLEQ (pin 28). The amplifier positioned after SLEQ (pin 28) has a mute function that is applied when the SLED OFF command is issued. The sled is moved by inputting current to SL^- (pin 30) and SL^+ (pin 31); specifically, the pins are connected to the microprocessor output ports via resistors, and the movement gain is set by the resistance value of that resistor. It is important to note that if there is a deviation in the resistance values for SL^- (pin 30) and SL^+ (pin 31), an offset will arise in the SLD output.

7. Spindle servo

This configures the servo circuit, which maintains the linear velocity of the disc at a constant speed, along with the DSP. This circuit accepts signals from the DSP through CV^- (pin 39) and CV^+ (pin 40) and sets the equalizer characteristics through SP (pin 24), SP^- (pin 26), and SPD (pin 27), which are output to SPD (pin 27). The 12-cm mode amplifier gain is set by the resistor connected between SPG (pin 25) and the reference voltage. In 8-cm mode, this amplifier serves as an internal buffer, and SPG (pin 25) is ignored. Note that the gain setting is made for 8-cm mode first, and then 12-cm mode. If SPG (pin 25) is left open, the gain is forcibly set for 8-cm mode, regardless of whether 8-cm or 12-cm mode is in effect.

8. TES and HFL (traverse signals)

When moving the pickup from the outer track to the inner track, the EF output from the pickup must be connected so that the phase relationship of TES and HFL is as shown in the diagram below. For the TESI input, the TES comparator has negative polarity and hysteresis of approximately $\pm 100mV$. An external bandpass filter is needed in order to extract only the required signal from the TE signal.

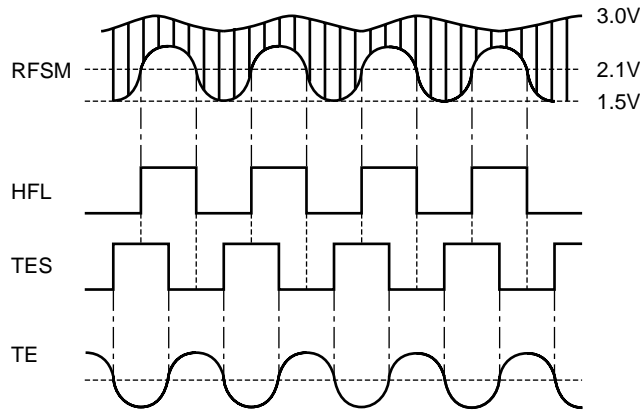

9. DRF (luminous energy determination)

DRF goes high when the peak of the EFM signal (RFSM output) held by the PH1 (pin 60) capacitor exceeds approximately 2.3V. The PH1 (pin 60) capacitor affects the DRF detection time constant and the RFAGC response bidirectional setting. The DRF output is driven by a constant current ($250\mu A$).

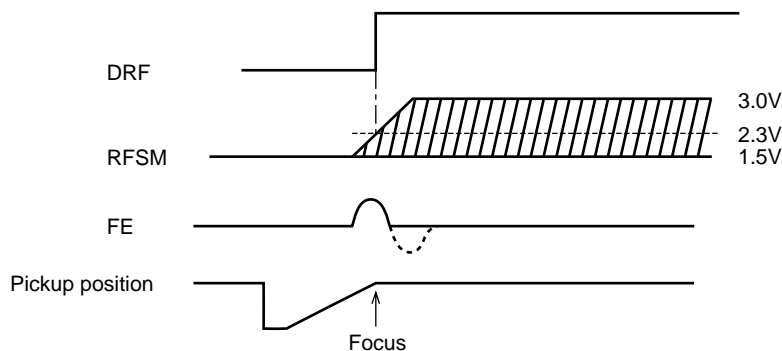

10. Focus determination

Focus is assumed to be obtained when the focus error signal S curve reaching REF +0.2V is detected, and the S curve subsequently returns to REF.

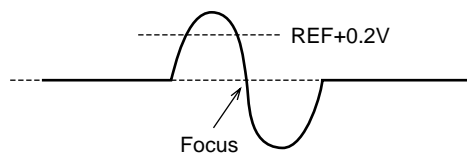

LA9242M

11. DEFECT

The mirrored surface level is maintained by the capacitor for LF2 (pin 59) ; when a drop in the EFM signal (RFSM output) reaches 0.35V or more, a high signal is output to DEF (pin 49). If DEF (pin 49) goes high, the tracking servo enters THLD mode. In order to prevent the tracking servo from entering THLD mode when a defect is detected, prevent DEFECT from being output by either shorting DEF (pin 49) to GND, or shorting LF2 (pin 59) to GND. The DEFECT output is driven by constant current (approximately 100 μ A).

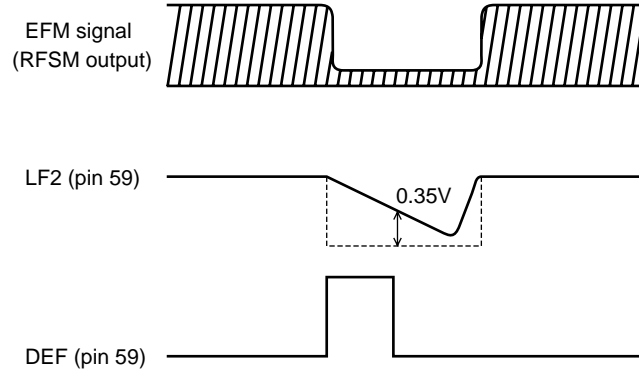

12. Microcontroller interface

Because the Reset (Nothing) command initializes the LA9242M, it must be used carefully.

The LA9242M command acceptance (mode switching) timing is defined by the internal clock (4.23MHz divided to 130kHz) after the falling edge of CE (RWC) ; therefore, when commands are sent consecutively, CE must go low for at least 10 μ s. The 4.23MHz clock is required for that reason. 2BYTE-COMMAND DETECT and 2BYTE-COMMAND RESET are used only for the purpose of masking two-byte data.

All instructions can be input by setting CE high and sending commands synchronized with the CL clock from the microcontroller to DAT (pin 52) in LSB first format. Note that the command is executed at the falling edge of CE.

Timing

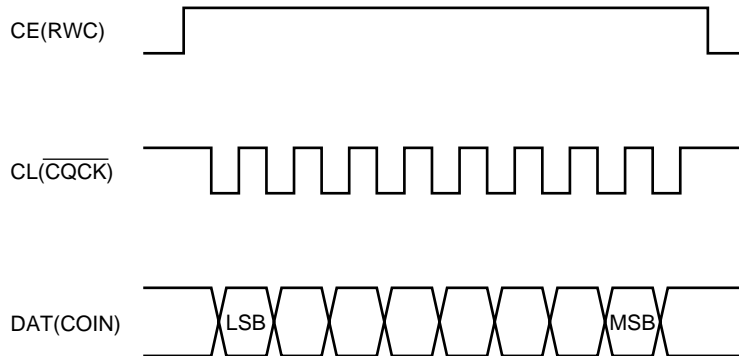

* The DSP pin names are shown in parentheses.

13. Reset circuit

The power-on reset is released when V_{CC} exceeds approximately 2.6V.

14. Pattern design notes

To prevent signal jump-in from CV^+ (pin 40) to RFSM (pin 41), a shielding line is necessary in between.

15. V_{CC} /REF/GND/NC

- V_{CC1} (pin 64) : RF system
- V_{CC2} (pin 56) : SERVO system, DIGITAL system
- AGND (pin 22) : RF system, SERVO system
- DGND (pin 45) : DIGITAL system
- NC (pin 23, 48) : No connection
- VR (pin 58) : Referred voltage

Microcontroller Command List

MSB	LSB	Command	Reset mode Power-on mode	DSP
0	0	RESET		RESET (NOTHING)
0	0	FOCUS START		FOCUS START #1
1	1	2BYTE-COMMAND DETECT		2BYTE-COMMAND DETECT
1	1	2BYTE-COMMAND DETECT		2BYTE-COMMAND DETECT
1	1	2BYTE-COMMAND RESET		2BYTE-COMMAND RESET
1	0	FOCUS-OFFSET ADJUST START		-
1	0	FOCUS-OFFSET ADJUST OFF	○	-
1	0	TRACK-OFFSET ADJUST START		-
1	0	TRACK-OFFSET ADJUST OFF	○	-
1	0	LASER ON		-
1	0	LASER OFF ; F-SERVO ON		-
1	0	LASER OFF ; F-SERVO OFF	○	-
1	0	SPINDLE 8CM		-
1	0	SPINDLE 12CM	○	-
1	0	SPINDLE OFF		-
1	0	SLED ON	○	-
1	0	SLED OFF		-
1	0	E/F BALANCE START	Non-adjusted	-
1	0	TRACK-SERVO OFF	○	-
1	0	TRACK-SERVO ON		-

Notes Concerning Microcontroller Program Creation

1. Commands

After sending the FOCUS START command and the E/F BALANCE START command, send 11111110 (FEH) in order to clear the internal registers of the IC.

Reason : Although the above commands are executed at point ① in the timing chart below, the same commands will be executed again at point ② if there is subsequent input to CE as shown below.

Timing

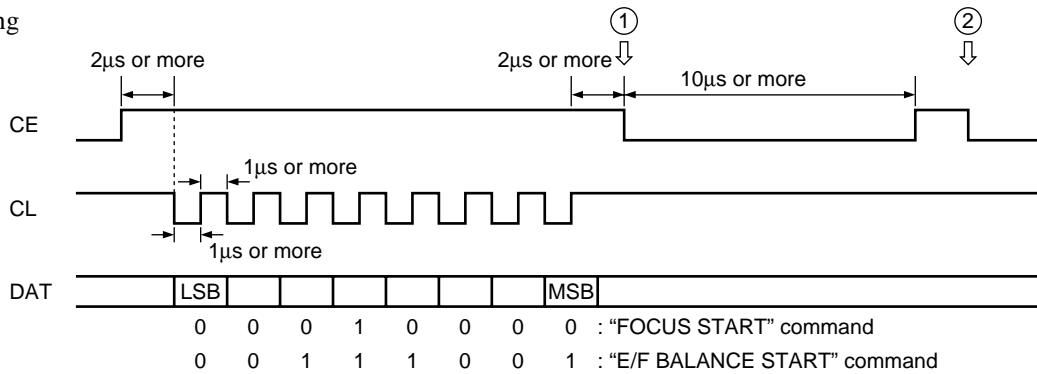

When sending the TRACK-OFFSET ADJUST START command or the FOCUS-OFFSET ADJUST START command after either V_{CC} ON (POWER ON RESET), RESET command, or a corresponding OFFSET ADJUST OFF command, waiting time is necessary as listed below. (Only when a 4.2MHz clock is input.)

TRACK-OFFSET ADJUST START : 4ms or more

FOCUS-OFFSET ADJUST START : 4ms or more

2. E/F balance adjustment

E/F balance adjustments should be made in a bit region of the disc, not a mirrored region.

Since there is no track-kick for LA9242M, measures must be taken during EF balance adjustment to obtain a stable TE signal. (By a sled movement signal from a microcontroller, for example.)

LA9242M

Pin Internal Equivalent Circuit

Pin No.	Pin name	Internal equivalent circuit
1 2	FIN2 FIN1	
3 4	E F	
5 6 17 21 26 28 44	TB TE ⁻ FD ⁻ FE ⁻ SP ⁻ SLEQ SLI	
16 27 43	FD SPD SLC	
8 36	TESI TES	

Continued on next page.

LA9242M

Continued from preceding page.

Pin No.	Pin name	Internal equivalent circuit
9 34	SCI TGL	
7 10	TE TH	
11 12	TA TD ⁻	
13	TD	

Continued on next page.

LA9242M

Continued from preceding page.

Pin No.	Pin name	Internal equivalent circuit
14	JP	
15	TO	
18 19 20	FA FA ⁻ FE	

Continued on next page.

LA9242M

Continued from preceding page.

Pin No.	Pin name	Internal equivalent circuit
25	SPG	
29 30 31	SLD SL ⁻ SL ⁺	
32 33	JP ⁻ JP ⁺	
35	TOFF	

Continued on next page.

LA9242M

Continued from preceding page.

Pin No.	Pin name	Internal equivalent circuit
<p>37 46 49 54</p>	<p>HFL FSC DEF DRF</p>	
<p>38</p>	<p>RW</p>	
<p>39 40 24</p>	<p>CV⁻ CV⁺ SP</p>	
<p>42</p>	<p>RFS⁻</p>	
<p>47</p>	<p>TBC</p>	

Continued on next page.

LA9242M

Continued from preceding page.

Pin No.	Pin name	Internal equivalent circuit
50	CLK	
51 52 53	CL DAT CE	
55	FSS	
57 58	REFI VR	
59	LF2	

Continued on next page.

LA9242M

Continued from preceding page.

Pin No.	Pin name	Internal equivalent circuit
<p style="text-align: center;">41 60 61</p>	<p style="text-align: center;">RFSM PH1 BH1</p>	
<p style="text-align: center;">62</p>	<p style="text-align: center;">LDD</p>	
<p style="text-align: center;">63</p>	<p style="text-align: center;">LDS</p>	

Function Comparisons for CD-ASP

Type	LA9220M	LA9230M	LA9231M	LA9233M	LA9240M	LA9241M	LA9242M
Package	QFP-64E	QFP-64E	QFP-64E	QFP-64E	QFP-64E	QFP-64E	QFP-64E
Allowable operating supply voltage	5.5V	5.5V	5.5V	5.5V	5.5V	5.5V	5.5V
V _{CCop} max	3.6V : t=-25 to +75° C	3.6V : t=-25 to +75° C	3.6V : t=-25 to +75° C	3.6V : t=-25 to +75° C	3.6V : t=-25 to +75° C	3.2V : t=-25 to +75° C	3.2V : t=-25 to +75° C
V _{CCop} min1						3.0V : t=-10 to +75° C	3.0V : t=-10 to +75° C
V _{CCop} min2							
Current drain (When V _{CC} =5V)	40mA	32mA	32mA	32mA	32mA	32mA	34mA
VCO circuit built in	Yes	No	No	No	No	No	No
Auto adjustment function							
• Focus offset adjustment	Adjustment position : FD 270ms	Adjustment position : FD 270ms	Adjustment position : FD 270ms	Adjustment position : FD 270ms	Adjustment position : FE 30ms	Adjustment position : FE 30ms	Adjustment position : FE 30ms
Maximum adjustment time							
Tracking offset adjustment	Adjustment position : TO 30ms	Adjustment position : TO 30ms	Adjustment position : TO 30ms	Adjustment position : TO 30ms	Adjustment position : TE 30ms	Adjustment position : TE 30ms	Adjustment position : TE 30ms
Maximum adjustment time							
• E/F balance auto adjustment	Yes	Yes	Yes	Yes	Yes	Yes	Yes
• RE level AGC function	Yes	Yes	Yes	Yes	Yes	Yes	Yes
RF waveform amplitude when V _{CC} =5V	1.8Vp-p	1.8Vp-p	1.8Vp-p	1.8Vp-p	1.8Vp-p	1.5Vp-p	1.5Vp-p
RF waveform amplitude when V _{CC} min	1.3Vp-p	1.3Vp-p	1.3Vp-p	1.3Vp-p	1.2Vp-p : V _{CC} =3.4V	0.9Vp-p : V _{CC} =3.0V	0.9Vp-p : V _{CC} =3.0V
• Tracking servo gain RF level following function	Yes	Yes	Yes	Yes	Yes	Yes	Yes
Focus search time	Approx. 280ms	Approx. 280ms	Approx. 1.1s	Approx. 1.1s	Approx. 560ms	Approx. 560ms	Approx. 560ms
Regeneration speed	×2	×2	×2	×4	×4	×4	×4 (Normal)
Track-kick signal output (Track-kick during E/F balance adjustment)	Built in	Built in	No output	No output	No output	No output	No output
Focus search smoothing capacitor pin : FSC	No	No	Yes	Yes	Yes	Yes	Yes
E/F balance variable range setting pin : TBC	No	No	No	No	Yes	Yes	Yes
Focus search mode switch pin : FSS	No	No	No	No	Yes	Yes	Yes
V _{th} for HFL detection	2.3V	2.3V	2.3V	2.3V	2.1V	2.1V	2.1V
DRF current capacity	Approx. 100µA	Approx. 100µA	Approx. 100µA	Approx. 100µA	Approx. 250µA	Approx. 250µA	Approx. 250µA
APC reference voltage	180mV : typ	180mV : typ	180mV : typ	180mV : typ	180mV : typ	190mV : typ	190mV : typ
LCD voltage where LDD=3V		Pin 46, 47, 48, 55	Pin 47, 48, 55	Pin 47, 48, 55	Pin 48	Pin 23, 48	Pin 23, 48
No connection							
Available for RW disc	No	No	No	No	No	No	Yes

- Specifications of any and all SANYO products described or contained herein stipulate the performance, characteristics, and functions of the described products in the independent state, and are not guarantees of the performance, characteristics, and functions of the described products as mounted in the customer's products or equipment. To verify symptoms and states that cannot be evaluated in an independent device, the customer should always evaluate and test devices mounted in the customer's products or equipment.
- SANYO Electric Co., Ltd. strives to supply high-quality high-reliability products. However, any and all semiconductor products fail with some probability. It is possible that these probabilistic failures could give rise to accidents or events that could endanger human lives, that could give rise to smoke or fire, or that could cause damage to other property. When designing equipment, adopt safety measures so that these kinds of accidents or events cannot occur. Such measures include but are not limited to protective circuits and error prevention circuits for safe design, redundant design, and structural design.
- In the event that any or all SANYO products(including technical data, services) described or contained herein are controlled under any of applicable local export control laws and regulations, such products must not be exported without obtaining the export license from the authorities concerned in accordance with the above law.
- No part of this publication may be reproduced or transmitted in any form or by any means, electronic or mechanical, including photocopying and recording, or any information storage or retrieval system, or otherwise, without the prior written permission of SANYO Electric Co., Ltd.
- Any and all information described or contained herein are subject to change without notice due to product/technology improvement, etc. When designing equipment, refer to the "Delivery Specification" for the SANYO product that you intend to use.
- Information (including circuit diagrams and circuit parameters) herein is for example only ; it is not guaranteed for volume production. SANYO believes information herein is accurate and reliable, but no guarantees are made or implied regarding its use or any infringements of intellectual property rights or other rights of third parties.

This catalog provides information as of April, 2002. Specifications and information herein are subject to change without notice.