



LC35V1000BM, BTS-70U

Asynchronous Silicon Gate 1M (131,072 words ×8 bits) SRAM

Preliminary

Overview

The LC35V1000BM and LC35V1000BTS-70U are asynchronous silicon gate CMOS static RAM devices with a 131,072-word by 8-bit structure. They provide two chip enable pins ($\overline{CE1}$ and $\overline{CE2}$) for device select/deselect control and one output enable pin (\overline{OE}) for output control. They feature high speed, low power, and a wide operating temperature range. This makes them optimal for use in systems that require high speed, low power, and battery backup. They also support easy memory expansion.

Features

- Low-voltage operation: 3.0 to 3.6 V
- Wide operating temperature range: -40 to $+85^{\circ}\text{C}$
- Access time: 70 ns (maximum): LC35V1000BM and LC35V1000BTS-70U.
- Low current drain
 - Standby mode: $0.05\ \mu\text{A}$ (typical*) at $T_a = +25^{\circ}\text{C}$ *:
 - When $V_{CC} = 3.0\ \text{V}$
 - $10.0\ \mu\text{A}$ (maximum) at $T_a = +70^{\circ}\text{C}$
 - $20.0\ \mu\text{A}$ (maximum) at $T_a = +85^{\circ}\text{C}$
- Data retention voltage: 2.0 to 3.6 V
- No clock required (fully static circuits)
- Input/output shared function pins, 3-state output pins
- Package
 - 32-pin SOP (525 mil) plastic package:
 - LC35V1000BM
 - 32-pin TSOP (8 × 14 mm) plastic package:
 - LC35V1000BTS

Package Dimensions

unit: mm

3205A-SOP32

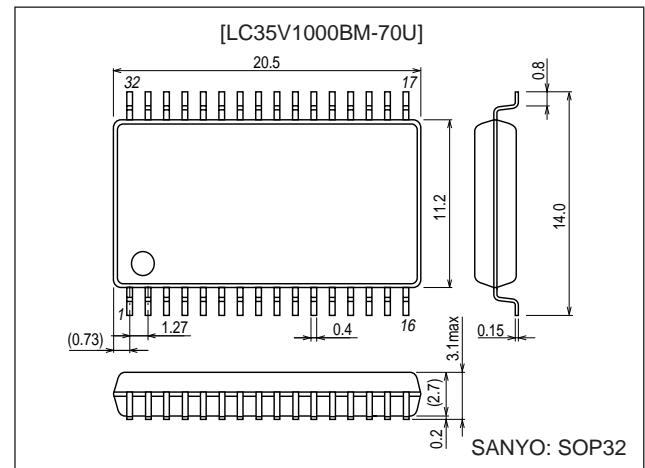

unit: mm

3228A-TSOP32DA

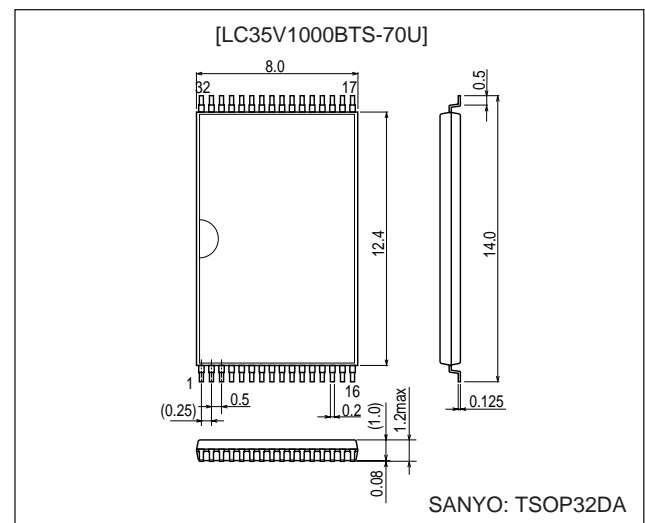

■ Any and all SANYO products described or contained herein do not have specifications that can handle applications that require extremely high levels of reliability, such as life-support systems, aircraft's control systems, or other applications whose failure can be reasonably expected to result in serious physical and/or material damage. Consult with your SANYO representative nearest you before using any SANYO products described or contained herein in such applications.

■ SANYO assumes no responsibility for equipment failures that result from using products at values that exceed, even momentarily, rated values (such as maximum ratings, operating condition ranges, or other parameters) listed in products specifications of any and all SANYO products described or contained herein.

SANYO Electric Co., Ltd. Semiconductor Company

TOKYO OFFICE Tokyo Bldg., 1-10, 1 Chome, Ueno, Taito-ku, TOKYO, 110-8534 JAPAN

Pin Assignment

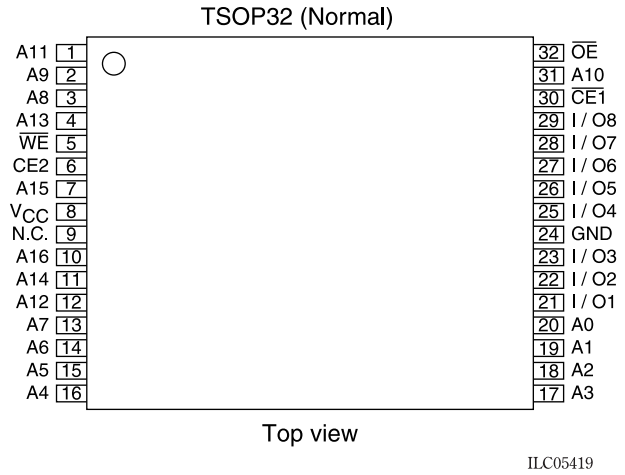
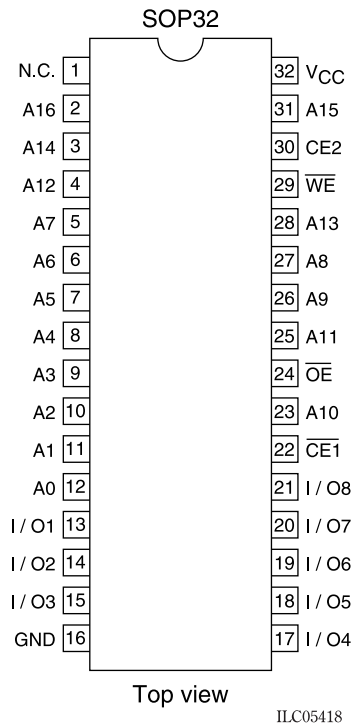

Block Diagram

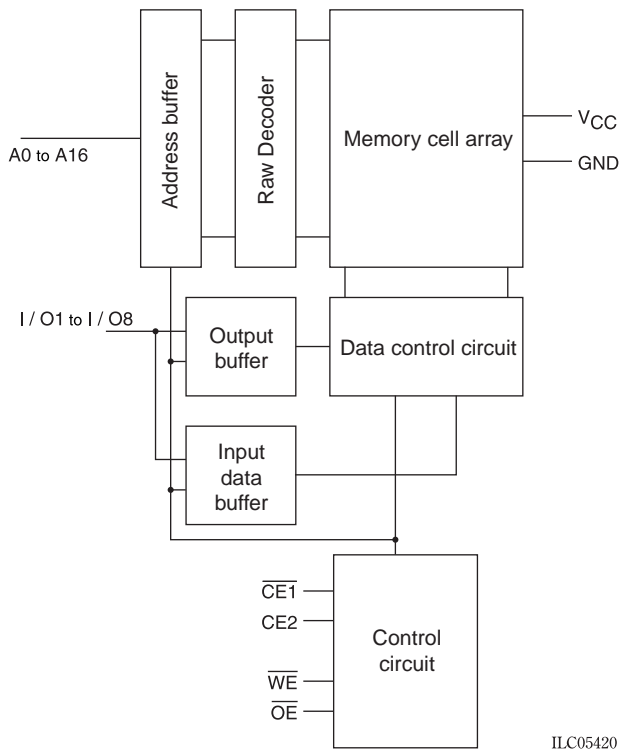

ILC05420

Pin Functions

A0 to A16	Address input
\overline{WE}	Ready/write control input
\overline{OE}	Output enable input
$\overline{CE1}$, $\overline{CE2}$	Chip enable input
I/O1 to I/O8	Data I/O
V_{CC} , GND	Power supply, ground

Function Table

Mode	$\overline{CE1}$	CE2	\overline{OE}	\overline{WE}	I/O	Supply current
Ready cycle	L	H	L	H	Data output	I_{CCA}
Write cycle	L	H	X	L	Data input	I_{CCA}
Output disable	L	H	H	H	High impedance	I_{CCA}
Unselected	H	X	X	X	High impedance	I_{CCS}
	X	L	X	X	High impedance	I_{CCS}

Note: X indicates H or L.

Specifications

Maximum Ratings at $T_a = 25^\circ\text{C}$

Parameter	Symbol	Conditions	Ratings	Unit
Maximum supply voltage	$V_{CC \text{ max}}$		4.6	V
Input pin voltage	V_{IN}		-0.3* to $V_{CC} + 0.3$	V
I/O pin voltage	$V_{I/O}$		-0.3 to $V_{CC} + 0.3$	V
Operating temperature	T_{opr}		-40 to +85	$^\circ\text{C}$
Storage temperature	T_{stg}		-55 to +125	$^\circ\text{C}$

*: For pulse widths under 30 ns: -2.0 V

Note: This chip may be destroyed if any stress in excess of the absolute maximum ratings is applied.

I/O Capacitances at $T_a = 25^\circ\text{C}$, $f = 1 \text{ MHz}$

Parameter	Symbol	Conditions	Ratings			Unit
			min	typ	max	
Input capacitance	C_{IN}	$V_{IN} = 0 \text{ V}$		6	10	pF
I/O capacitance	$C_{I/O}$	$V_{I/O} = 0 \text{ V}$		6	10	pF

Note: These parameters are not measured for all devices, but are sampled values.

LC35V1000BM, BTS-70U

DC Allowable Operating Range at Ta = -40 to +85°C

Parameter	Symbol	Conditions	Ratings			Unit
			min	typ	max	
Supply voltage	V _{CC}		3.0	3.3	3.6	V
High-level input voltage	V _{IH}		0.8V _{CC}		V _{CC} + 0.3	V
Low-level input voltage	V _{IL}		-0.3*		0.2V _{CC}	V

Note: * The minimum value is -2.0 V for pulse width under 30 ns.

DC Electrical Characteristics at Ta = -40 to +85°C, V_{CC} = 3.0 to 3.6 V

Parameter	Symbol	Conditions	Ratings			Unit
			min	typ	max	
Input leakage current	I _{LI}	V _{IN} = 0 to V _{CC}	-1.0		+1.0	μA
I/O leakage current	I _{LO}	V _{CE1} = V _{IH} or V _{CE2} = V _{IL} or V _{OE} = V _{IH} or V _{WE} = V _{IL} , V _{I/O} = 0 to V _{CC}	-1.0		+1.0	μA
Output high-level voltage	V _{OH1}	V _{OH1} = -2.0 mA	V _{CC} - 0.4			V
	V _{OH2}	V _{OH2} = -100 μA	V _{CC} - 0.1			V
Output low-level voltage	V _{OL1}	V _{OL1} = 2.0 mA			0.4	V
	V _{OL2}	V _{OL2} = -100 μA			0.1	V
Operating supply current (CMOS inputs)	I _{CCA2}	V _{CE1} = V _{IL} , V _{CE2} = V _{IH} , I _{I/O} = 0 mA, V _{IN} = V _{IH} or V _{IL}			1.2	mA
	I _{CCA3}	V _{CE1} = V _{IL} , V _{CE2} = V _{IH} , I _{I/O} = 0 mA, V _{IN} = V _{IH} or V _{IL} , DUTY100%	min cycle 1 μs cycle	2	25	mA
Standby mode supply current (V _{CC} - 0.2 V/0.2 V inputs) (CMOS inputs)	I _{CCS1}	V _{CE2} ≤ 0.2 V or (V _{CE1} ≥ V _{CC} - 0.2 V, V _{CE2} ≥ V _{CC} - 0.2 V)	Ta ≤ 85°C		20	μA
			Ta ≤ 70°C		10	
			Ta ≤ 25°C	0.05		
I _{CCS2}	V _{CE1} = V _{IH} or V _{CE2} = V _{IL} , V _{IN} = 0 to V _{CC}			0.4	mA	

Note: * Reference values when V_{CC} = 3.0 V and Ta = 25°C.

AC Electrical Characteristics at $T_a = -40$ to $+85^\circ\text{C}$, $V_{CC} = 3.0$ to 3.6 V

AC test conditions

Input pulse voltage levels: $V_{IL} = 0.2 V_{CC}$, $V_{IH} = 0.8 V_{CC}$

Input rise and fall times: 5 ns

Input and output timing levels: $0.5 V_{CC}$

Output load: 30 pF (including the jig capacitance)

Read cycle

Parameter	Symbol	min	max	Unit
Read cycle time	t_{RC}	70		ns
Address access time	t_{AA}		70	ns
$\overline{CE1}$ access time	t_{CA1}		70	ns
CE2 access time	t_{CA2}		70	ns
\overline{OE} access time	t_{OA}		40	ns
Output hold time	t_{OH}	10		ns
$\overline{CE1}$ output enable time	t_{COE1}	5		ns
CE2 output enable time	t_{COE2}	5		ns
\overline{OE} output enable time	t_{OCE}	0		ns
$\overline{CE1}$ output disable time	t_{COD1}		35	ns
CE2 output disable time	t_{COD2}		35	ns
\overline{OE} output disable time	t_{OOD}		30	ns

Write cycle

Parameter	Symbol	min	max	Unit
Write cycle time	t_{WC}	70		ns
Address setup time	t_{AS}	0		ns
Write pulse width	t_{WP}	50		ns
$\overline{CE1}$ setup time	t_{CW1}	60		ns
CE2 setup time	t_{CW2}	60		ns
Write recovery time	t_{WR}	0		ns
$\overline{OE1}$ write recovery time	t_{WR1}	0		ns
CE2 write recovery time	t_{WR2}	0		ns
Data setup time	t_{DS}	40		ns
Data hold time	t_{DH}	0		ns
$\overline{OE1}$ data hold time	t_{DH1}	0		ns
CE2 data hold time	t_{DH2}	0		ns
\overline{WE} output enable time	t_{WOE}	5		ns
\overline{WE} output disable time	t_{WOD}		35	ns

Timing Charts

Read cycle (1)

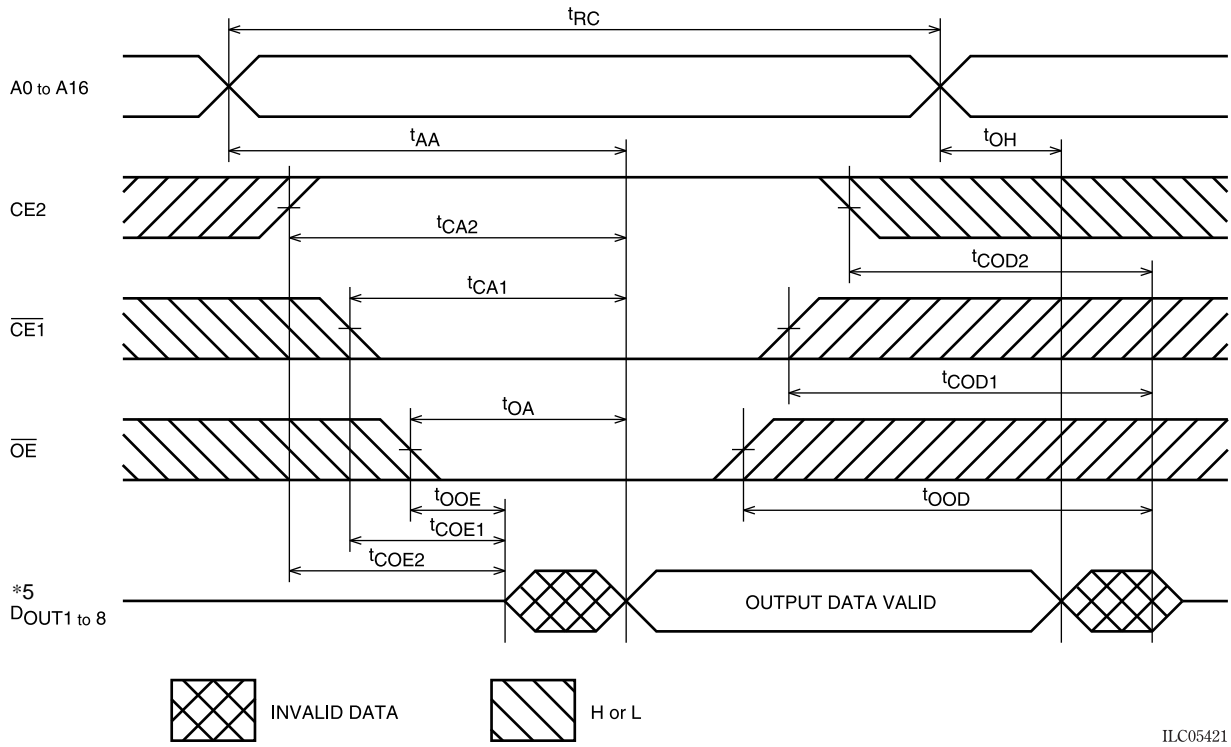

Write cycle (1) ($\overline{\text{WE}}$ write)

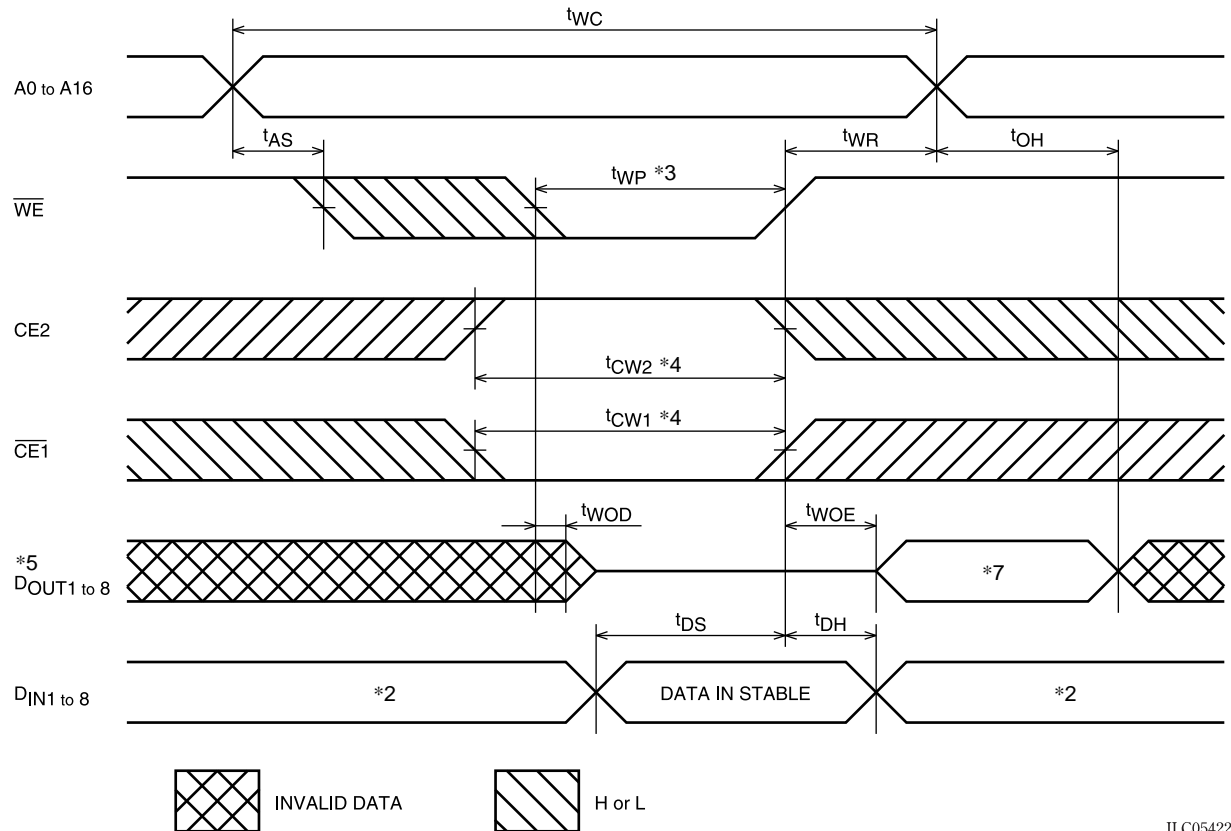

LC35V1000BM, BTS-70U

Write cycle (2) ($\overline{\text{CE1}}$ write)

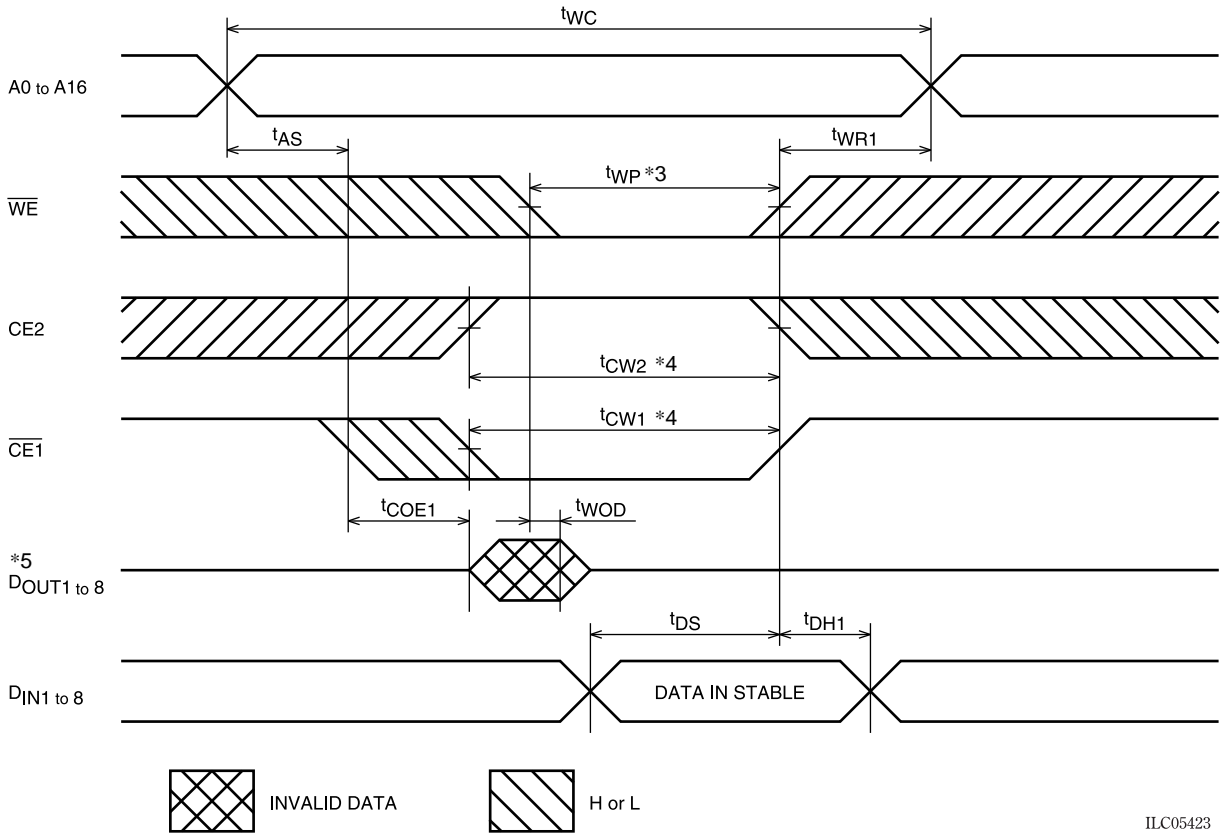

ILC05423

Write cycle (2) (CE2 write)

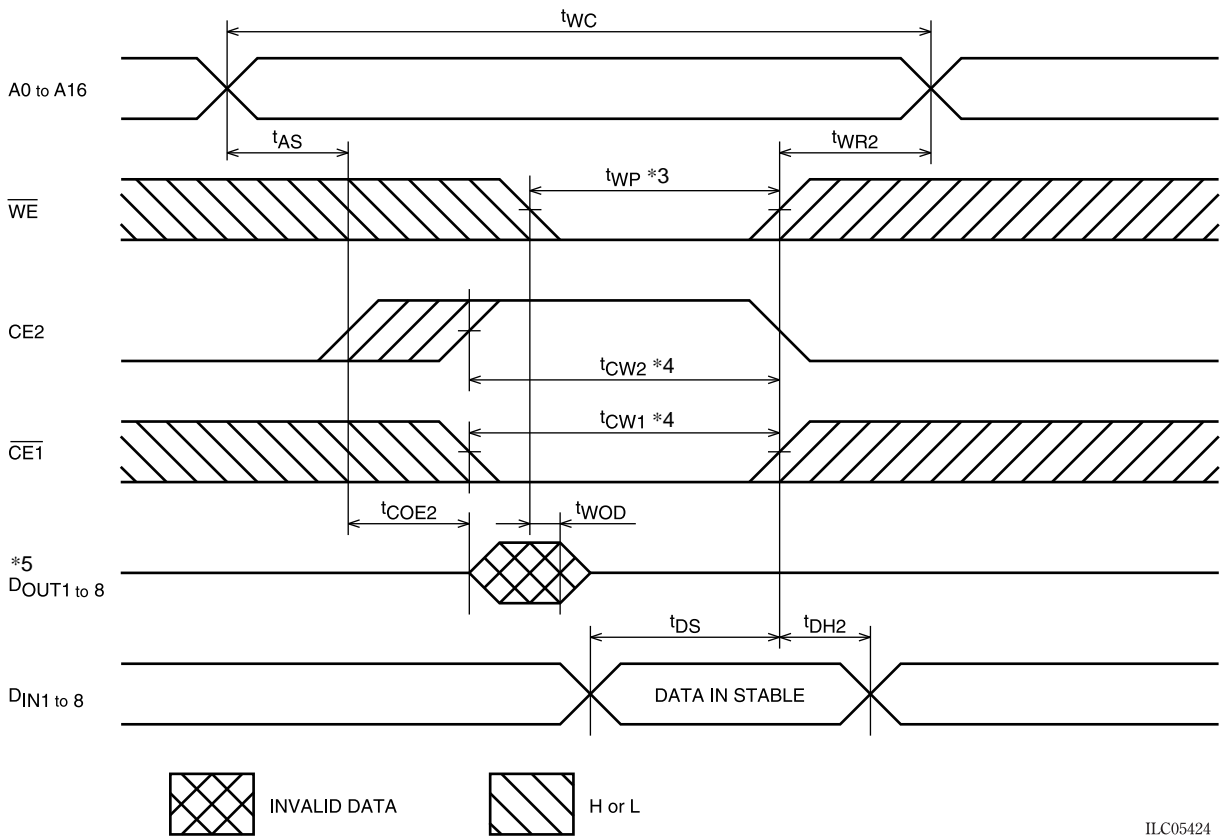

ILC05424

- Notes:
1. The times t_{COD1} , t_{COD2} , t_{OOD} , and t_{WOD} are stipulated as the times until the output reaches the high-impedance state. They are not stipulated by output voltage level.
 2. Do not apply reverse phase signals to the data outputs when the data outputs are in the output state.
 3. t_{WP} is the period that $\overline{CE1}$ and \overline{WE} are at the low level and CE2 is at the high level, and is defined as the time from the fall of \overline{WE} until the rise of $\overline{CE1}$ or \overline{WE} or the fall of CE2, whichever occurs first.
 4. t_{CW1} and t_{CW2} are the period that $\overline{CE1}$ and \overline{WE} are at the low level and CE2 is at the high level, and are defined as the time from the fall of $\overline{CE1}$ or the rise of CE2 to the rise of either $\overline{CE1}$ or \overline{WE} or the fall of CE2, whichever occurs first.
 5. The data outputs go to the high-impedance state when any one of the following states hold: \overline{OE} is at the high level, $\overline{CE1}$ is at the high level, CE2 is at the low level, or \overline{WE} is at the low level.
 6. If \overline{OE} is at the high level during the write cycle, the data outputs will go to the high-impedance state.

Data Retention Characteristics at Ta = -40 to +85°C

Parameter	Symbol	Conditions	Ratings			Unit
			min	typ	max	
Data retention supply voltage	V_{DR1}	$V_{CE1} \geq V_{CC} - 0.2 V, V_{CE2} \geq V_{CC} - 0.2 V$ or $V_{CE2} \leq 0.2 V$	2.0		3.6	V
	V_{DR2}	$V_{CE2} \leq 0.2 V$	2.0		3.6	V
Data retention supply current	I_{CCDR1}	$V_{CC} = 3.0 V, V_{CE1} \geq V_{CC} - 0.2 V,$ $V_{CE2} \geq V_{CC} - 0.2 V,$ or $V_{CE2} \leq 0.2 V$			16	μA
			-40°C to +85°C		8	
			-40°C to +70°C +25°C	0.05		
Chip enable setup time	t_{CDR}		0			ns
Chip enable hold time	t_R		5			ms

Note: * Ta = +25°C

Data Retention Waveforms (1) ($\overline{CE1}$ control)

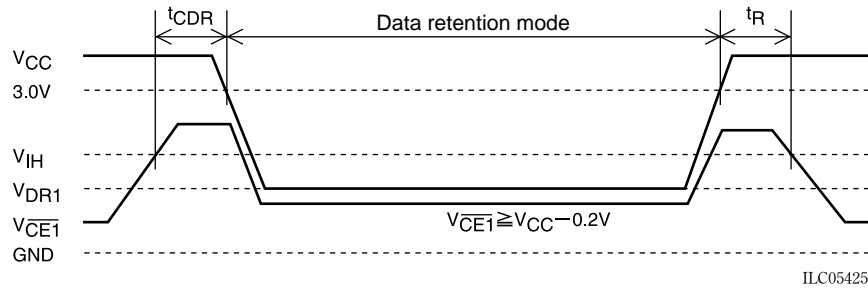

ILC05425

Data Retention Waveforms (2) (CE2 control)

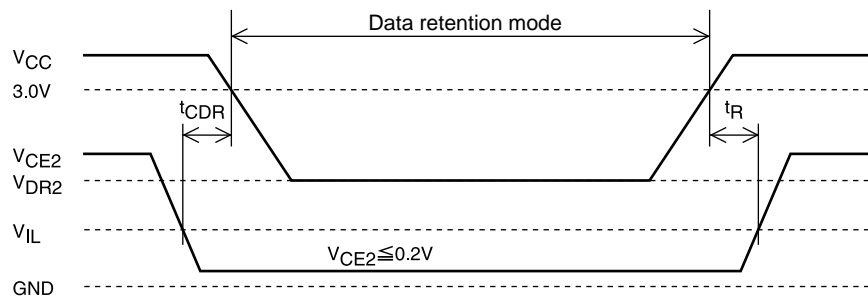

ILC05426

- Specifications of any and all SANYO products described or contained herein stipulate the performance, characteristics, and functions of the described products in the independent state, and are not guarantees of the performance, characteristics, and functions of the described products as mounted in the customer's products or equipment. To verify symptoms and states that cannot be evaluated in an independent device, the customer should always evaluate and test devices mounted in the customer's products or equipment.
- SANYO Electric Co., Ltd. strives to supply high-quality high-reliability products. However, any and all semiconductor products fail with some probability. It is possible that these probabilistic failures could give rise to accidents or events that could endanger human lives, that could give rise to smoke or fire, or that could cause damage to other property. When designing equipment, adopt safety measures so that these kinds of accidents or events cannot occur. Such measures include but are not limited to protective circuits and error prevention circuits for safe design, redundant design, and structural design.
- In the event that any or all SANYO products (including technical data, services) described or contained herein are controlled under any of applicable local export control laws and regulations, such products must not be exported without obtaining the export license from the authorities concerned in accordance with the above law.
- No part of this publication may be reproduced or transmitted in any form or by any means, electronic or mechanical, including photocopying and recording, or any information storage or retrieval system, or otherwise, without the prior written permission of SANYO Electric Co., Ltd.
- Any and all information described or contained herein are subject to change without notice due to product/technology improvement, etc. When designing equipment, refer to the "Delivery Specification" for the SANYO product that you intend to use.
- Information (including circuit diagrams and circuit parameters) herein is for example only; it is not guaranteed for volume production. SANYO believes information herein is accurate and reliable, but no guarantees are made or implied regarding its use or any infringements of intellectual property rights or other rights of third parties.

This catalog provides information as of April, 2002. Specifications and information herein are subject to change without notice.