



SLP-9117E-51

ø3.1mm red contact type LED lamp (U-cut version)

Features

- GaAsP red LED
- 3.1mmø, U-cut type lamp
- Light red epoxy resin package type
- The insertion which made it stick to PCB is possible
- High luminous intensity, high reliability and long life
- Application : for the general public welfare

Absolute Maximum Ratings at Ta=25°C (as per JIS C 7032)

Parameter	Symbol	Rating	Unit
Forward Current *1	I _F	25	mA
Pulse Forward Current *2	I _{FP}	100	mA
Reverse Voltage	V _R	3	V
Power Dissipation	P _D	70	mW
Operating Temperature	T _{opr}	-25 to +80	°C
Storage Temperature	T _{stg}	-30 to +85	°C
Soldering Temperature *3	T _{sol}	260	°C

*1 See forward current derating

*2 Pulse width = Max. 10ms Duty ratio = Max. 1 / 10

*3 Max. 5sec., Lead soldering condition : Min. 1.6mm from case (used 1.6mm'ts PCB)

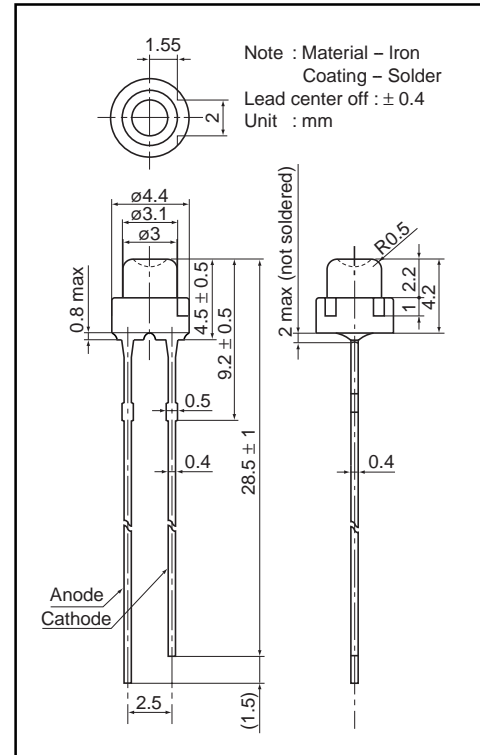

Electrical / Optical Characteristics at Ta=25°C

Parameter	Symbol	Conditions	Min.	Typ.	Max.	Unit
Forward Voltage	V _F	I _F = 20mA	1.7	2.1	2.8	V
Reverse Current	I _R	V _R = 3V	-	-	10	μA
Luminous Intensity *4	I _V	I _F = 20mA	4.2	8	-	mcd
Peak Wave length	λ _p	I _F = 20mA	-	630	-	nm
Line Half Width	Δλ	I _F = 20mA	-	40	-	nm
Capacitance	C _O	V _O = 0 • F = 1MHz	-	40	-	pF
Response Time	t	-	-	90	-	ns

*4 Luminous Intensity is measured by J-16 (SONY TEKTRONIX) of which our office possess.

Typical Characteristics



These shows the electrical and optical characteristics of this products, and not assure this dispersive contents.

Forward Current vs. Forward Voltage

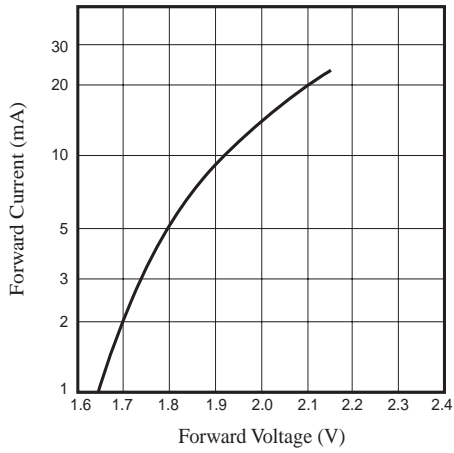

Intensity vs. Temperature (I_F : constant)

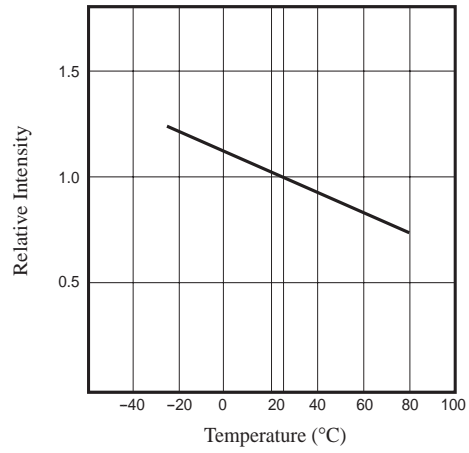

Intensity vs. Current

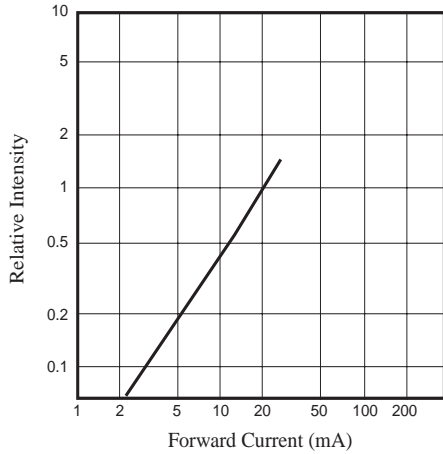

Spectrum

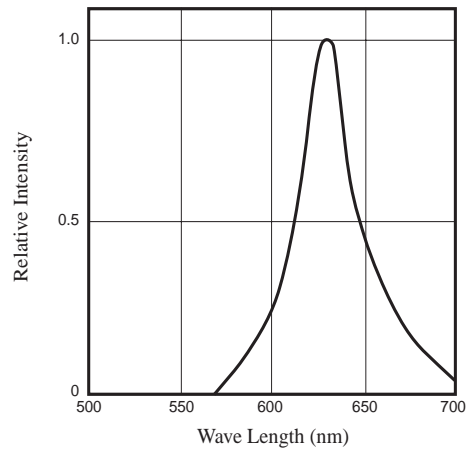

Forward Current Derating (Abusolute Maximum Rating)

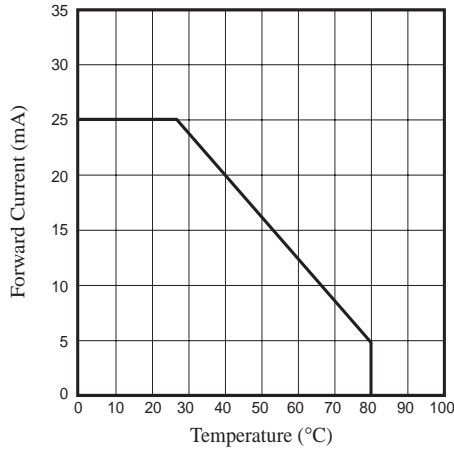

Directivity

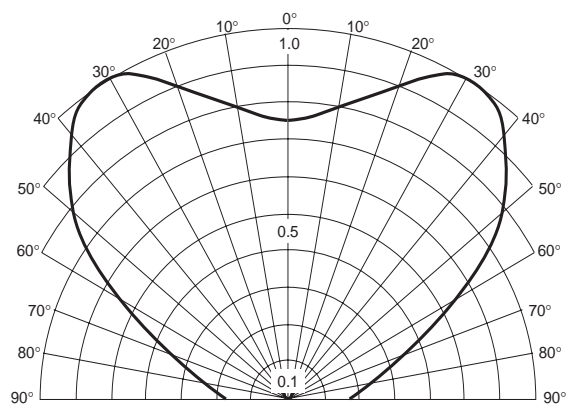

PRECAUTIONS

- (1) Bending a lead should avoid not to cause chip deterioration or so. When bending is necessary, care must be taken considering the following points :
 - ① Bending a lead must be done before soldering.
 - ② Bending a lead must be done in the states of fixing a lead tight and applying no stress on the resin part; otherwise it may cause troubles such as gold wire breaking.
 - ③ A lead must be bent at intervals of 1.6mm from the edge of the resin part.
 - ④ Do not bend the same portion of lead more than twice.
- (2) Setting a product by a tool such as holder should avoid. When necessary, no stress should be applied to the resin part and lead by sufficient considerations on dimension tolerance, thermal expansion, thermal contraction of holder, product and circuit board.
- (3) The hole pitch of a circuit board must fit to its lead pitch.
- (4) When soldering, care must be taken considering the following points :
 - ① Do not heat a product under any stress (ex. : twist) to leads.
 - ② Do not heat (by soldering, for example) a product in the states of being forced to the resin part.
- (5) Do not use the flux containing chlorine which may cause corrosion of lead and washing is preferable. When washing is necessary, avoid washing the whole product and wash only the needed part under the following conditions.
 - Chemicals : Methyl alcohol
 - Temperature : 45°C max.
 - Time : 30sec. max.

 **CAUTION**

1. No products described or contained herein are intended for use in surgical implants, life-support systems, aerospace equipment, nuclear power control systems, vehicles, disaster / crime-prevention equipment or the like, and the failure of which may directly or indirectly cause injury, death or property loss.
2. Anyone purchasing any products described or contained herein for an above-mentioned use shall:
 - 1) Accept full responsibility and indemnify and defend SANYO ELECTRIC CO.,LTD., it's affiliates, subsidiaries and distributors or any of their officers and employees, jointly and severally, against any and all claims and litigation and all damages, costs and expenses associated with such use.
 - 2) Not impose any responsibility for any fault or negligence which may be cited in any such claim or litigation on SANYO ELECTRIC CO., LTD., it's affiliates, subsidiaries and distributors or any of their officers and employees jointly or severally.
3. Information (including circuit diagrams and circuit parameters) disclosed herein is for example only; it is not guaranteed for mass production, SANYO believes the information disclosed herein is accurate and reliable, but no guarantees are made or implied regarding it's use or any infringements of intellectual property rights or other rights of third parties.

Precautionary instructions in handling gallium arsenic products

Special precautions must be taken in handling this product because it contains, gallium arsenic, which is designated as a toxic substance by law. Be sure to adhere strictly to all applicable laws and regulations enacted for this substance, particularly when it comes to disposal.

Manufactured by ; **Tottori SANYO Electric Co., Ltd.**
LED Division
5-318, Tachikawa-cho, Tottori City, 680-8634 Japan
TEL: +81-857-21-2137 FAX: +81-857-21-2161