

POWER MANAGEMENT

Description

The SC1461 is a versatile charge pump designed for use in battery operated power supply applications. A simple, low current boost circuit can be implemented without costly inductors or capacitors. Internal MOSFETs and control circuitry eliminate the need for costly board space and design time. The small device footprint allows for compact circuit design.

The SC1461 is a Capless™ charge pump for applications that require up to 8mA of output current. Three modes of output voltage can be programmed via the ADJ pin.

Modes include:

$$V_o = (1.32 * V_{IN}) \pm 4\% @ 7\text{mA of output current}$$

$$V_o = (1.515 * V_{IN}) \pm 4\% @ 4\text{mA of output current}$$

and the adjustable mode where an external resistor divider determines the output voltage.

The SC1461 is packaged in a 5 lead SOT-23 package.

Features

- ◆ Small size - 5 pin SOT-23 package
- ◆ 4% voltage accuracy
- ◆ 65uA typ. quiescent current
- ◆ User selectable output voltages of $1.515 * V_{IN}$, $1.32 * V_{IN}$, or adjustable output
- ◆ All specifications rated over full temperature range (-40°C to 85°C)

Applications

- ◆ PDA Power Supplies
- ◆ Notebook Power Supplies
- ◆ Peripheral Card Supplies
- ◆ Industrial Power Supplies
- ◆ High Density DC/DC Conversion

Typical Application Circuit

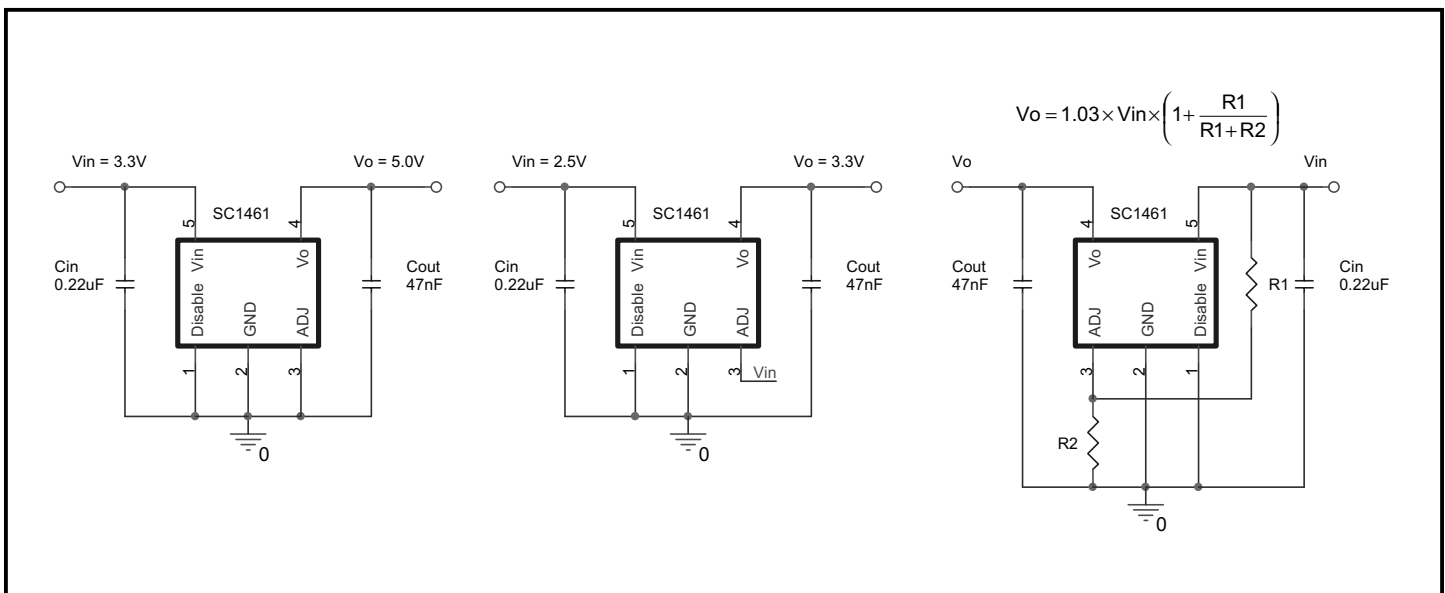

POWER MANAGEMENT
Absolute Maximum Ratings

Parameter	Symbol	Maximum	Units
Supply Voltage	V_{IN}	-0.3 to +4	V
Output Voltage	VO	-0.3 to +6	V
Thermal Resistance Junction to Ambient	θ_{JA}	410	°C/W
Operating Temperature	T_A	-40 to +85	°C
Temperature Range	T_J	-40 to +125	°C
Storage Temperature	T_{STG}	-65 to 150	°C
Lead Temperature (Soldering) 10 Seconds	T_L	300	°C

Electrical Characteristics

Unless specified: $2.25V \leq V_{IN} \leq 3.63V$, $0 \leq I_o \leq 8mA$, $C_{in} = 0.22\mu F$, $C_{out} = 47nF$, $T_a = -40$ to $85^\circ C$

Parameter	Symbol	Conditions	Min	Typ	Max	Units
Input Supply Voltage	V_{IN}		2.25		3.63	V
Input Supply Current	I_{IN}	ADJ, DISABLE = GND, $I_o = 0mA$, $V_{IN} = 3.3V$		65	100	μA
		ADJ = GND, DISABLE = V_{IN} $I_o = 0mA$, $V_{IN} = 3.3V$		0.1	1	
Output Voltage	V_o	ADJ, DISABLE = GND, $I_o \leq 4mA$	-4	$1.515 \times V_{IN}$	4	%
		ADJ = V_{IN} , DISABLE = GND, $I_o \leq 7mA$	-4	$1.32 \times V_{IN}$	4	
Output Ripple (pk-pk) ⁽¹⁾	V_R	ADJ = V_{IN} , DISABLE = GND, $I_o \leq 7mA$		50		mV
Output Current	I_o	ADJ = $V_{IN} = 2.5V$, DISABLE = GND	7	8		mA
		ADJ, DISABLE = GND, $V_{IN} = 3.3V$	4	7		mA
Efficiency ⁽¹⁾	η	ADJ = $V_{IN} = 2.5V$, DISABLE = GND $I_o = 7mA$		50		%
Oscillator Frequency ⁽²⁾	OSC	ADJ = $V_{IN} = 2.5V$, DISABLE = GND		12		MHz
		ADJ, DISABLE = GND, $V_{IN} = 3.3V$		13.5		
Time to Regulation at Turn-On ⁽¹⁾	t_{ON}	ADJ = $V_{IN} = 2.5V$, DISABLE = GND $I_o = 7mA$, $C_{OUT} = 47nF$		25		μs
Disable Threshold Voltage	D_{ISHI}			1	1.3	V
	D_{ISLO}		.5	0.9		V
Disable current	$I_{DISABLE}$	Disable = 0V		1	10	μA

NOTES:

- (1) All electrical characteristics are for the application circuit on page 1.
- (2) Guaranteed by design.
- (3) This device is ESD sensitive. Use of standard ESD handling precautions is required.

POWER MANAGEMENT

Pin Configuration

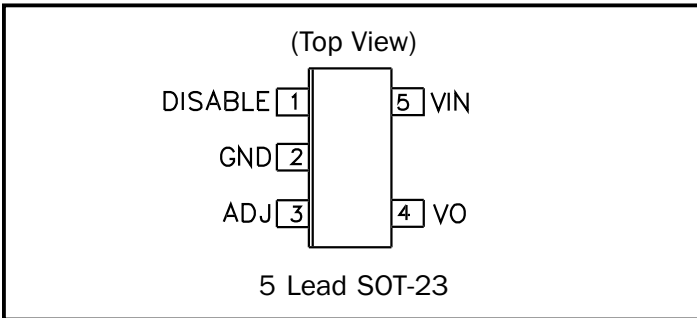

Ordering Information

Device ⁽¹⁾	Package
SC1461ISKTR	5-SOT-23
SC1461EVB	Evaluation Board

Note: (1) Only available in tape and reel packaging. A reel contains 3000 devices.

Pin Descriptions

Pin #	Pin Name	Pin Function
1	DISABLE	Disable pin is internally pulled to V_{IN} resulting in standby mode and the output will be disabled. Grounding this pin will enable the output.
2	GND	Ground.
3	ADJ	Mode selection pin. Grounding this pin will yield $V_o = 1.515 \cdot V_{in}$. Pulling this pin to V_{IN} will yield $V_o = 1.32 \cdot V_{IN}$. An external voltage divider connected at V_{IN} will achieve: $V_o = 1.03 \times V_{in} \times \left(1 + \frac{R1}{R1+R2} \right)$ See Applications Circuits.
4	VO	Voltage output.
5	VIN	Supply voltage input.

Block Diagram

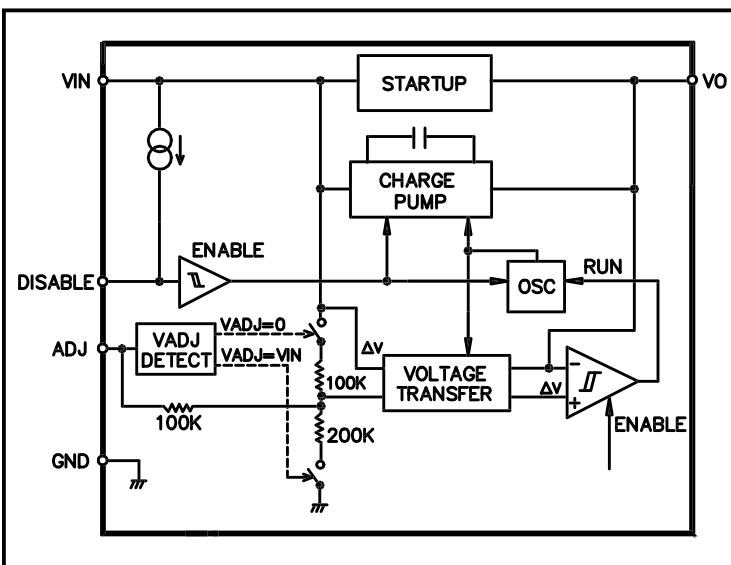

Marking Information

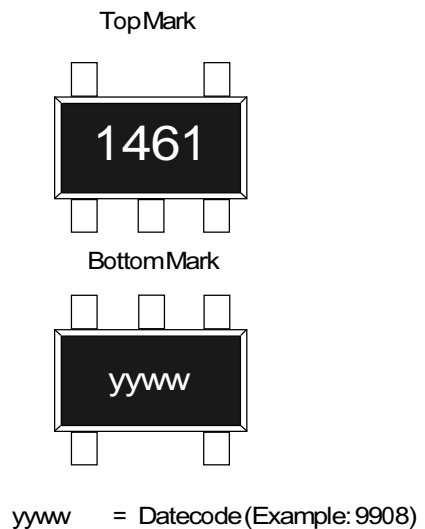

POWER MANAGEMENT
Typical Characteristics

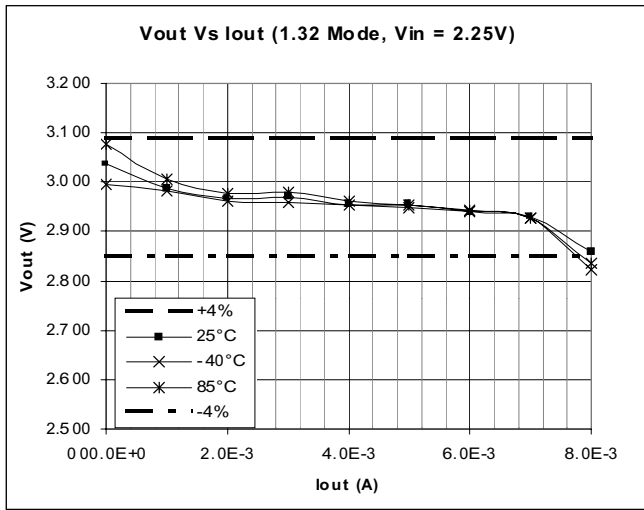

Typical Vout vs Iout
 1.32 Mode Vin = 2.25V

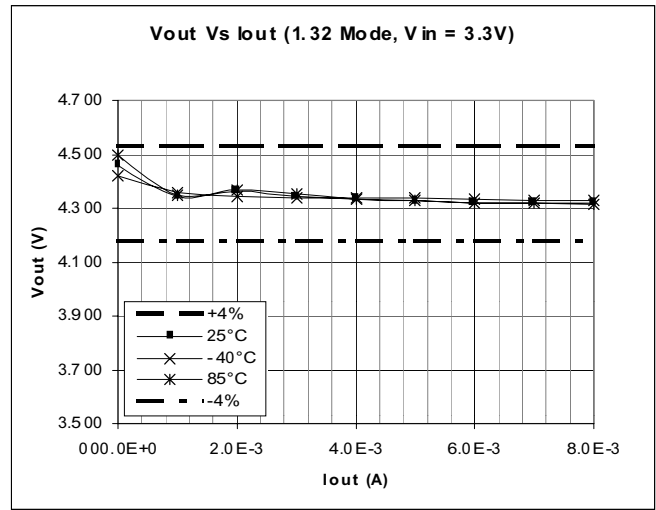

Typical Vout vs Iout
 1.32 Mode Vin = 3.30V

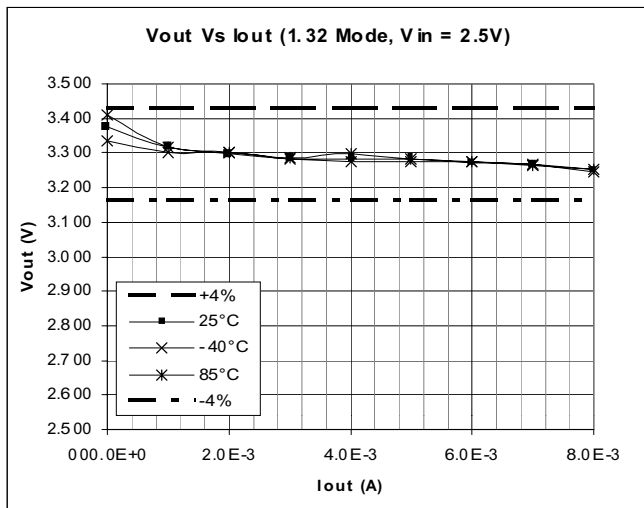

Typical Vout vs Iout
 1.32 Mode Vin = 2.50V

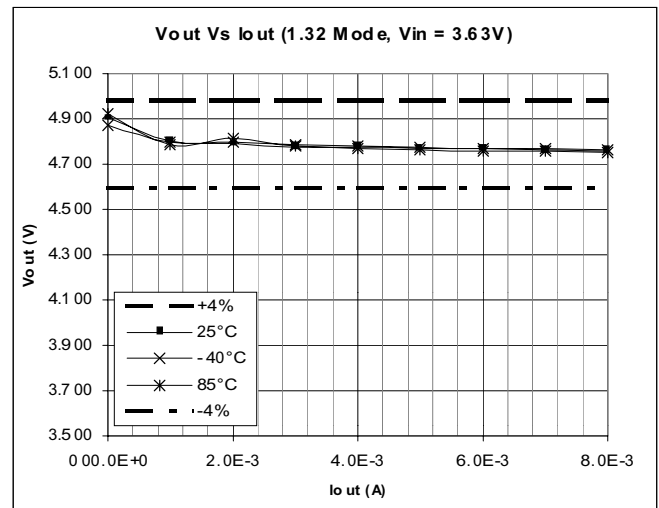

Typical Vout vs Iout
 1.32 Mode Vin = 3.63V

POWER MANAGEMENT

Typical Characteristics

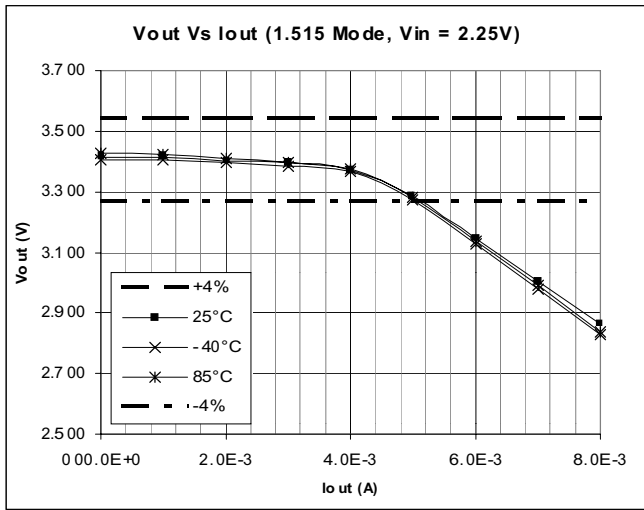

Typical Vout vs Iout
1.515 Mode Vin = 2.25V

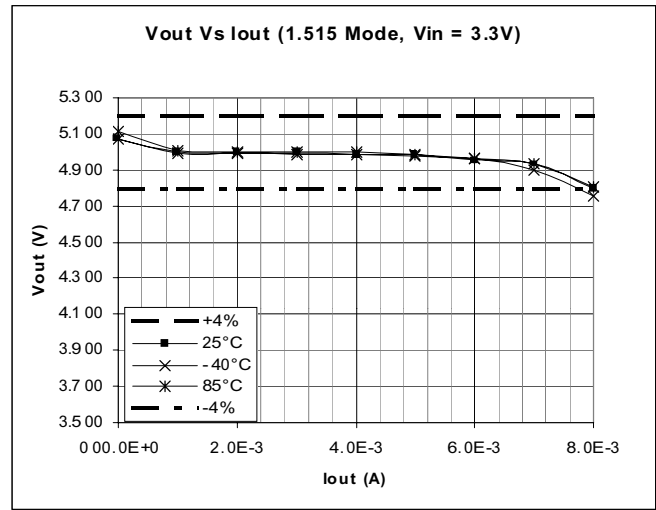

Typical Vout vs Iout
1.515 Mode Vin = 3.30V

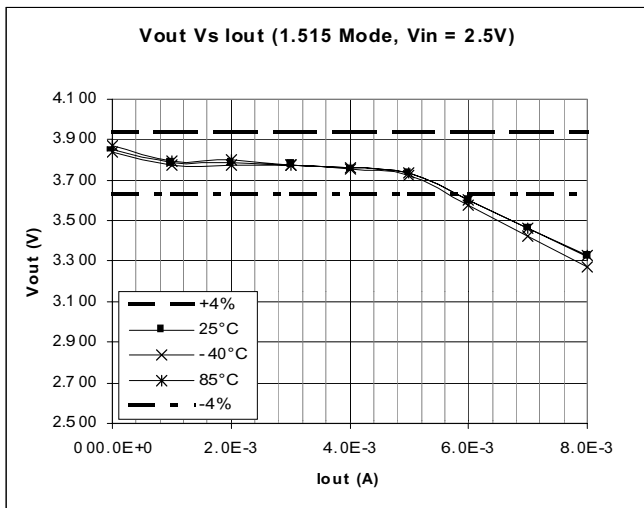

Typical Vout vs Iout
1.515 Mode Vin = 2.50V

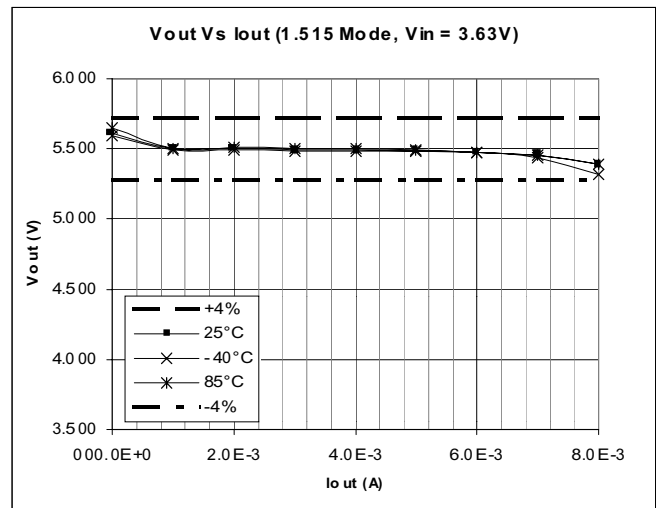

Typical Vout vs Iout
1.515 Mode Vin = 3.63V

POWER MANAGEMENT

Typical Characteristics

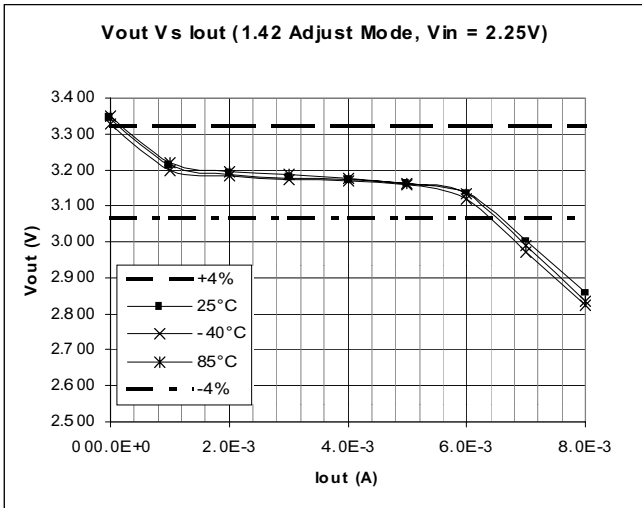

Typical Vout vs Iout
Adjust Mode = 1.42 * Vin Vin = 2.25V

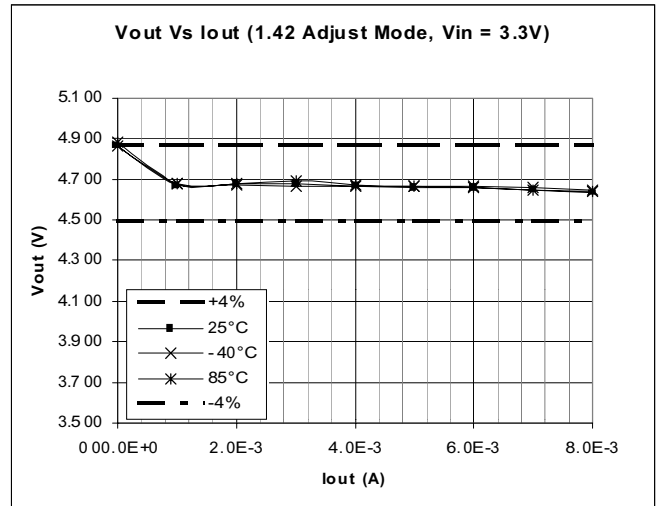

Typical Vout vs Iout
Adjust Mode = 1.42 * Vin Vin = 3.30V

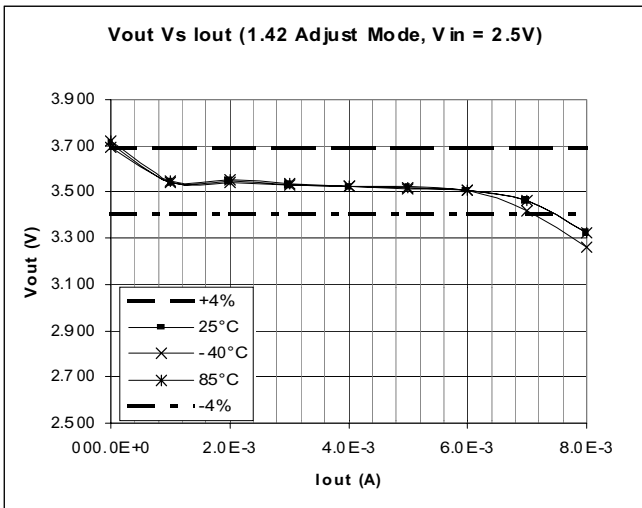

Typical Vout vs Iout
Adjust Mode = 1.42 * Vin Vin = 2.50V

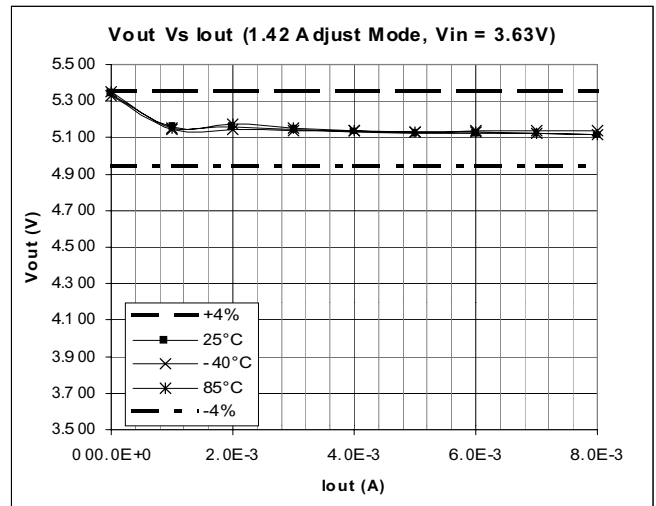

Typical Vout vs Iout
Adjust Mode = 1.42 * Vin Vin = 3.63V

POWER MANAGEMENT

Typical Characteristics

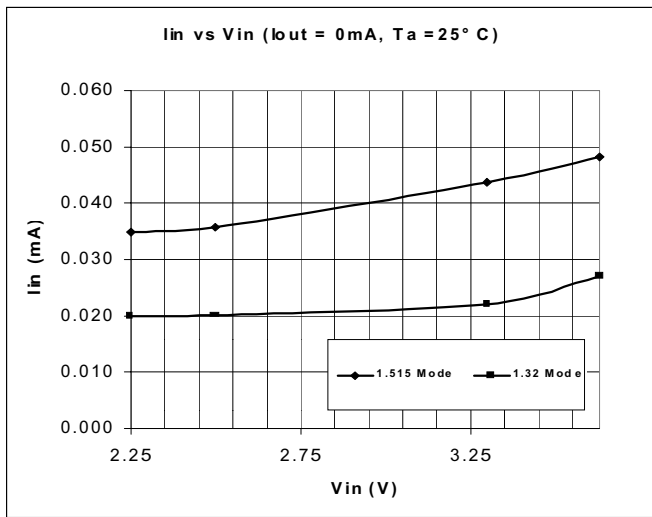

Typical I_{in} vs V_{in}
 $I_{out} = 0\text{mA}$ $T_a = 25^\circ\text{C}$

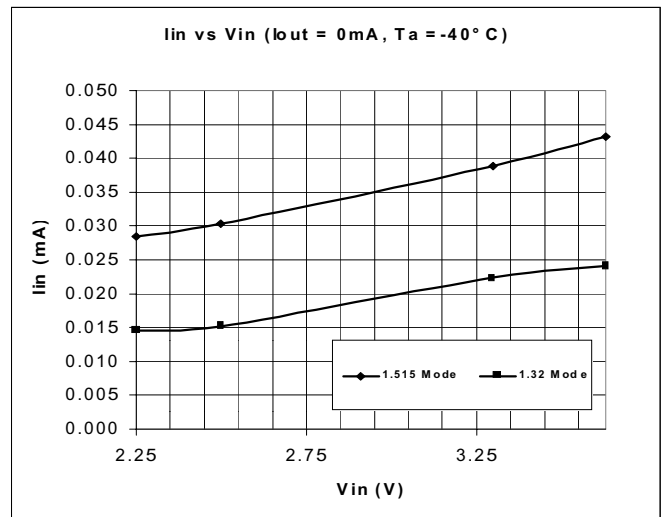

Typical I_{in} vs V_{in}
 $I_{out} = 0\text{mA}$ $T_a = -40^\circ\text{C}$

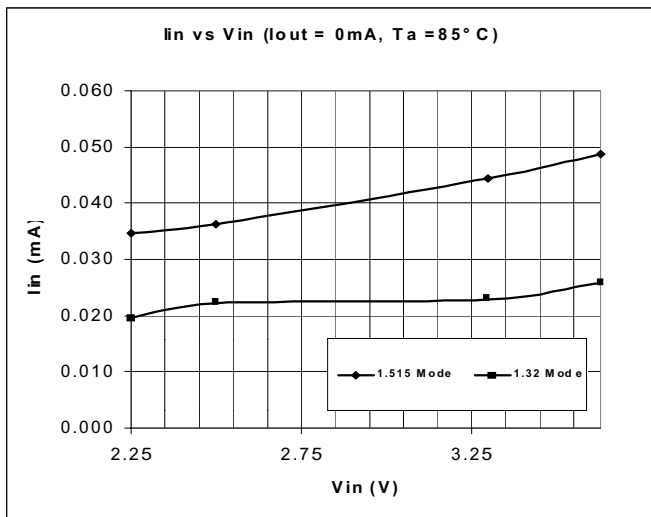

Typical I_{in} vs V_{in}
 $I_{out} = 0\text{mA}$ $T_a = 85^\circ\text{C}$

POWER MANAGEMENT

Outline Drawing - SOT-23-5L

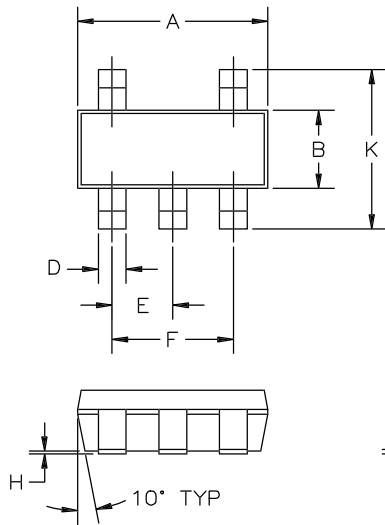

DIM ^N	INCHES		MM		NOTE
	MIN	MAX	MIN	MAX	
A	.110	.120	2.80	3.05	—
B	.059	.070	1.50	1.75	—
C	.036	.051	.90	1.30	—
D	.014	.020	.35	.50	—
E	.033	.040	.85	1.05	—
F	.067	.083	1.7	2.1	—
H	.0004	.006	.010	.150	—
J	.0035	.008	.090	.20	—
K	.102	.118	2.6	3.00	—

- ② PACKAGE OUTLINE EXCLUSIVE OF MOLD FLASH AND METAL BURR.
- ① CONTROLLING DIMENSIONS: MILLIMETERS.

Land Pattern - SOT-23-5L

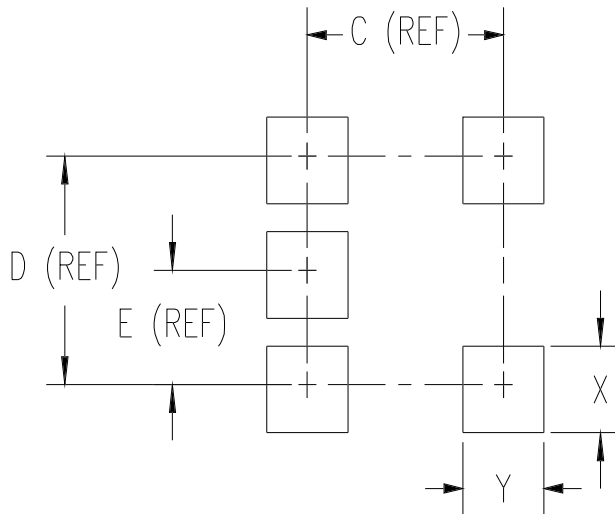

DIMENSIONS			
DIM ^N	INCHES	MM	NOTE
C	.094	2.4	—
D	.074	1.9	—
E	.037	.95	—
X	.028	.7	—
Y	.039	1.0	—

Contact Information

Semtech Corporation
 Power Management Products Division
 652 Mitchell Rd., Newbury Park, CA 91320
 Phone: (805)498-2111 FAX (805)498-3804