

# PQ05RF2/21/2V Series

2A Output, Low Power-Loss Voltage Regulators

## ■ Features

- Low power-loss (Dropout voltage : MAX. 0.5V)
- Compact resin full-mold package.
- Built-in ON/OFF control terminal (PQ05RF2/PQ05RF21 series)
- Built-in output voltage minute adjustment terminal (ripple rejection is improved) (PQ05RF2V series)

## ■ Model Line-ups

Output voltage	5V Output	9V Output	12V Output	15V Output
Output voltage precision:±5%	PQ05RF2	PQ09RF2	PQ12RF2	PQ15RF2
Output voltage precision:±2.5%	PQ05RF21	PQ09RF21	PQ12RF21	PQ15RF21
Minute adjustment (Output voltage adjustment range:±10%)	PQ05RF2V	PQ09RF2V	PQ12RF2V	PQ15RF2V

## ■ Applications

- Series power supply for various electronic equipment such as VCRs, electronic music instruments

## ■ Equivalent Circuit Diagram

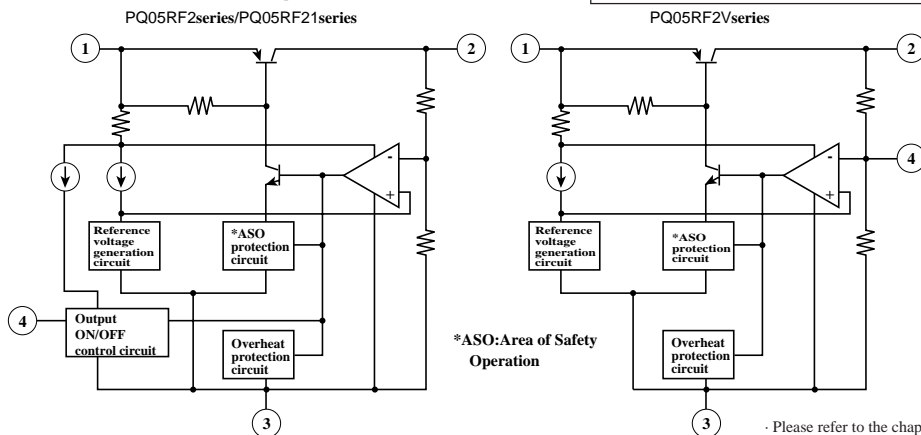

## ■ Outline Dimensions

(Unit : mm)

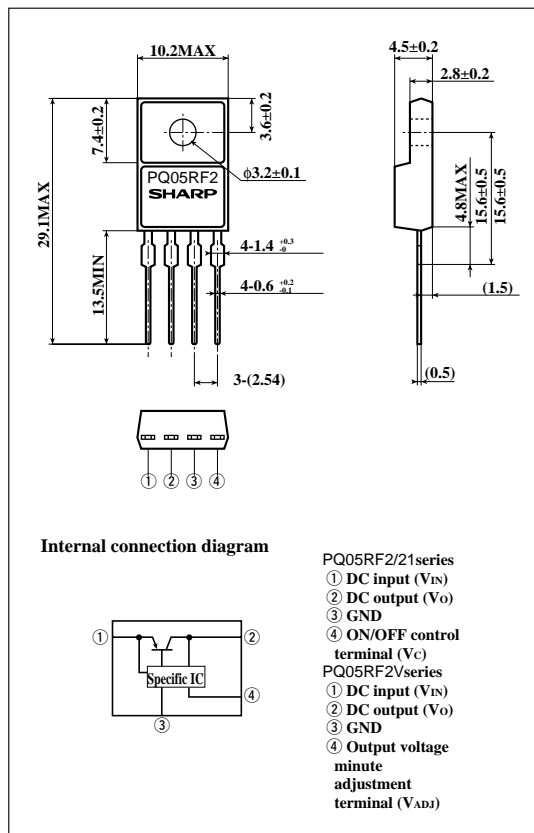

· Please refer to the chapter " Handling Precautions ".

**SHARP**

" In the absence of confirmation by device specification sheets, SHARP takes no responsibility for any defects that may occur in equipment using any SHARP devices shown in catalogs, data books, etc. Contact SHARP in order to obtain the latest version of the device specification sheets before using any SHARP's device. "

■ Absolute Maximum Ratings

(T<sub>a</sub>=25°C)

Parameter		Symbol	Rating	Unit
*1	Input voltage	V <sub>IN</sub>	35	V
*1	ON/OFF control terminal voltage	PQ05RF2 series	35	V
		PQ05RF21 series		
	Output current	I <sub>o</sub>	2	A
	Power dissipation (No heat sink)	P <sub>D1</sub>	1.5	W
	Power dissipation (With infinite heat sink)	P <sub>D2</sub>	18	W
*2	Junction temperature	T <sub>j</sub>	150	°C
	Operating temperature	T <sub>opr</sub>	-20 to +80	°C
	Storage temperature	T <sub>stg</sub>	-40 to +150	°C
	Soldering temperature	T <sub>sol</sub>	260 (For 10s)	°C

\*1 All are open except GND and applicable terminals.

\*2 Overheat protection may operate at 125<T<sub>j</sub><150°C.

■ Electrical Characteristics

(Unless otherwise specified, condition shall be I<sub>o</sub>=1A, T<sub>a</sub>=25°C, \*3)

Parameter		Symbol	Conditions	MIN.	TYP.	MAX.	Unit
Output voltage	PQ05RF2/PQ05RF2V	V <sub>o</sub>	-	4.75	5.0	5.25	V
	PQ09RF2/PQ09RF2V			8.55	9.0	9.45	
	PQ12RF2/PQ12RF2V			11.4	12.0	12.6	
	PQ15RF2/PQ15RF2V			14.25	15.0	15.75	
	PQ05RF21			4.88	5.0	5.12	
	PQ09RF21			8.78	9.0	9.22	
	PQ12RF21			11.7	12.0	12.3	
	PQ15RF21	14.63	15.0	15.37			
Load regulation		R <sub>egL</sub>	I <sub>o</sub> =5mA to 2A	-	0.5	2.0	%
Line regulation		R <sub>egI</sub>	*4	-	0.5	2.5	%
Temperature coefficient of output voltage		T <sub>cV<sub>o</sub></sub>	T <sub>j</sub> =0 to 125°C	-	±0.02	-	%/°C
Ripple rejection	PQ05RF2/PQ05RF21Series	RR	I <sub>o</sub> =0.5A Refer to Fig.2	45	55	-	dB
	PQ05RF2VSeries			55	-	-	dB
Dropout voltage		V <sub>i-o</sub>	*5, I <sub>o</sub> =2A	-	-	0.5	V
ON-state voltage for control	PQ05RF2/PQ05RF21Series	V <sub>C(ON)</sub>	-	2.0 *6	-	-	V
ON-state current for current	PQ05RF2/PQ05RF21Series	I <sub>C(ON)</sub>	V <sub>C</sub> =2.7V	-	-	20	μA
OFF-state voltage for control	PQ05RF2/PQ05RF21Series	V <sub>C(OFF)</sub>	-	-	-	0.8	V
OFF-state current for control	PQ05RF2/PQ05RF21Series	I <sub>C(OFF)</sub>	V <sub>C</sub> =0.4V	-	-	-0.4	mA
Quiescent current		I <sub>q</sub>	I <sub>o</sub> =0	-	-	10	mA
Output voltage minute adjustment range	PQ05RF2V	V <sub>O(ADJ)</sub>	-	4.5	5.0	5.5	V
	PQ09RF2V			8.1	9.0	9.9	
	PQ12RF2V			10.8	12.0	13.2	
	PQ15RF2V			13.5	15.0	16.5	

\*3 PQ05RF2 Series:V<sub>IN</sub>=7V, PQ09RF2 Series:V<sub>IN</sub>=15V, PQ12RF2 Series:V<sub>IN</sub>=18V, PQ15RF2 Series:V<sub>IN</sub>=23V

\*4 PQ05RF2/PQ05RF21/PQ05RF2V:V<sub>IN</sub>=6 to 12V PQ09RF2/PQ09RF21/PQ09RF2V:V<sub>IN</sub>=10 to 25V  
 PQ12RF2/PQ12RF21/PQ12RF2V:V<sub>IN</sub>=13 to 29V PQ15RF2/PQ15RF21/PQ15RF2V:V<sub>IN</sub>=16 to 32V

\*5 Input voltage shall be the value when output voltage is 95% in comparison with the initial value.

\*6 In case of opening control terminal ④, output voltage turns on.(PQ05RF2/PQ05RF21 Series)

Fig.1 Test Circuit

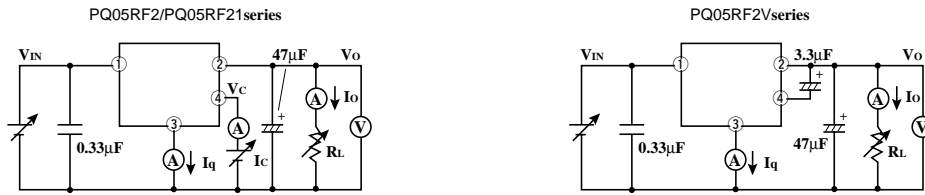

Fig.2 Test Circuit of Ripple Rejection

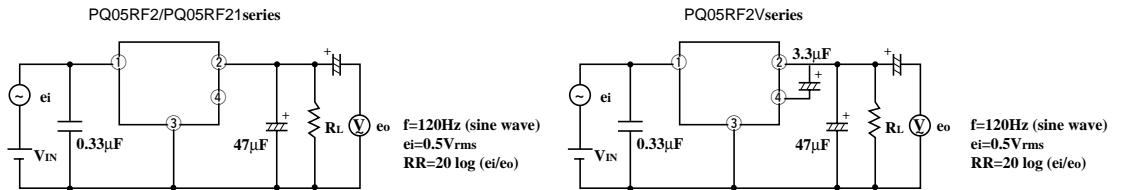
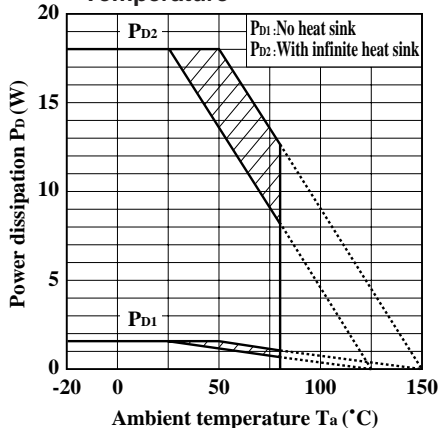

Fig.3 Power Dissipation vs. Ambient Temperature



Note) Oblique line portion: Overheat protection may operate in this area.

Fig.4 Overcurrent Protection Characteristics (Typical value)

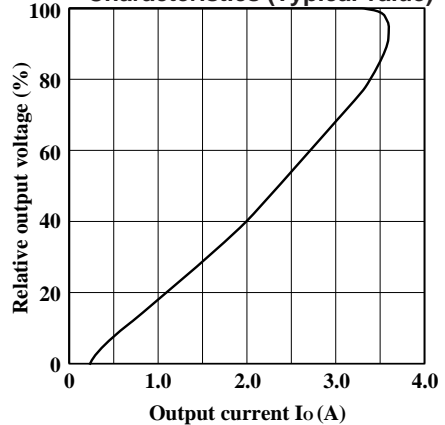

Fig.5 Output Voltage Minute Adjustment Characteristics (PQ05RF2V)

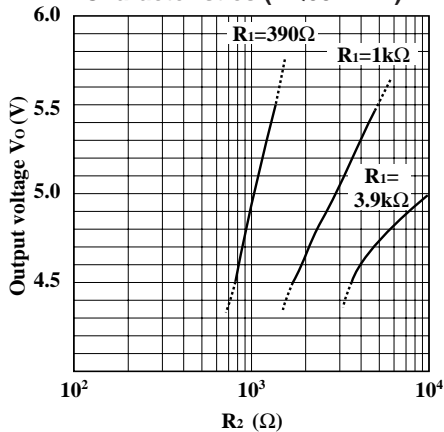

Fig.6 Output Voltage Minute Adjustment Characteristics (PQ09RF2V)

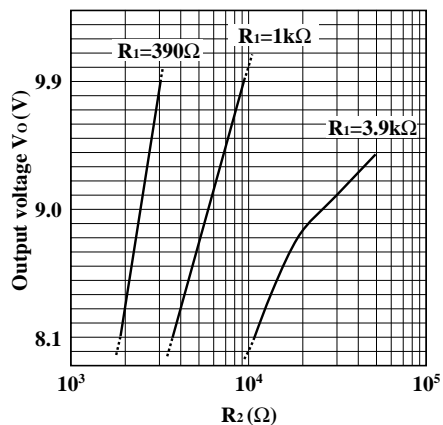

Fig.7 Output Voltage Minute Adjustment Characteristics (PQ12RF2V)

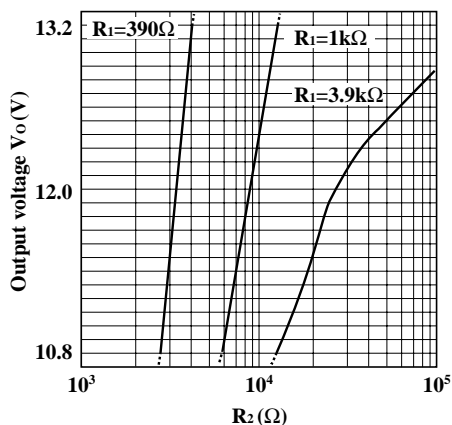

Fig.8 Output Voltage Minute Adjustment Characteristics (PQ15RF2V)

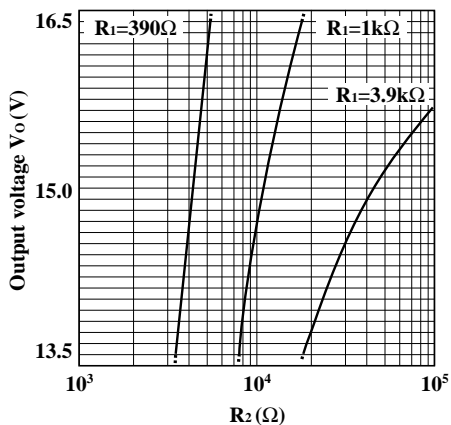

Fig.9 Output Voltage Deviation vs. Junction Temperature (PQ05RF2/PQ05RF21/PQ05RF2V)

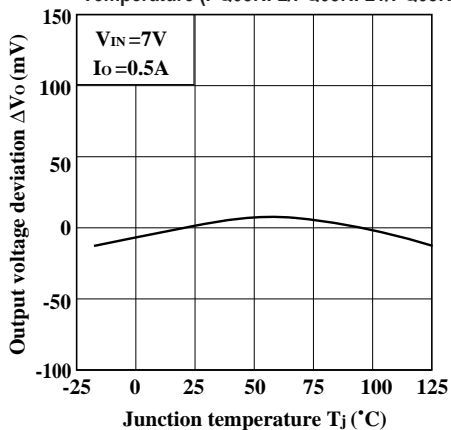

Fig.10 Output Voltage Deviation vs. Junction Temperature (PQ09RF2/PQ09RF21/PQ09RF2V)

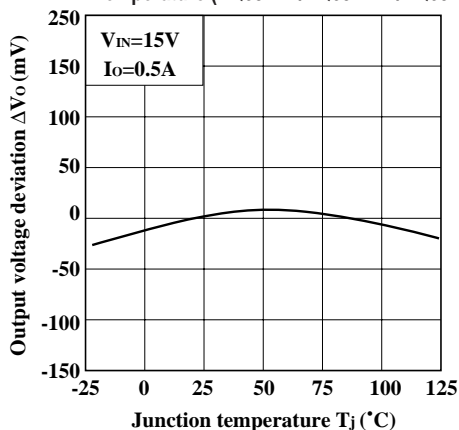

Fig.11 Output Voltage Deviation vs. Junction Temperature (PQ12RF2/PQ12RF21/PQ12RF2V)

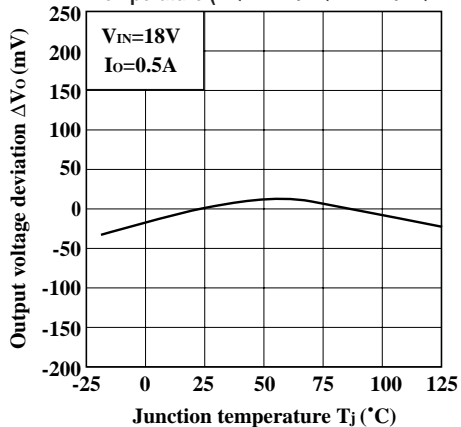

Fig.12 Output Voltage Deviation vs. Junction Temperature (PQ15RF2/PQ15RF21/PQ15RF2V)

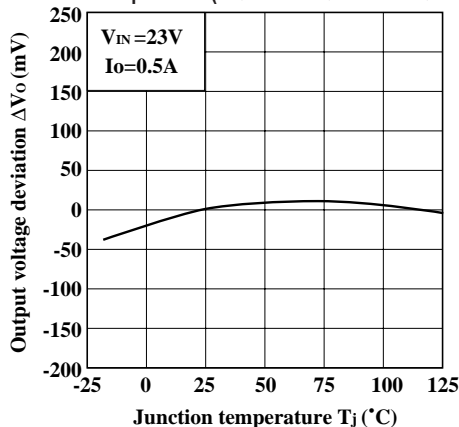

Fig.13 Output Voltage vs. Input Voltage (PQ05RF2/PQ05RF21/PQ05RF2V)

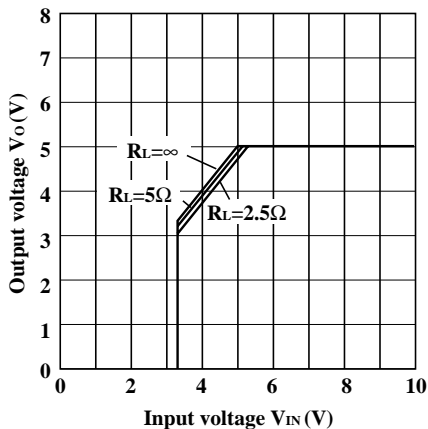

Fig.14 Output Voltage vs. Input Voltage (PQ09RF2/PQ09RF21/PQ09RF2V)

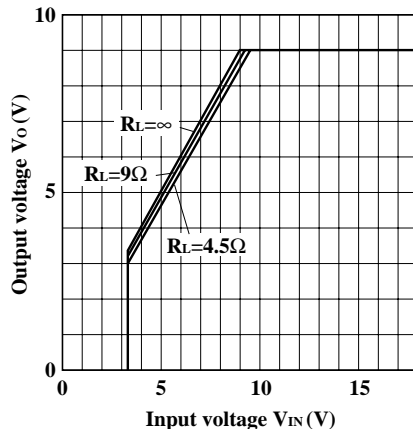

Fig.15 Output Voltage vs. Input Voltage (PQ12RF2/PQ12RF21/PQ12RF2V)

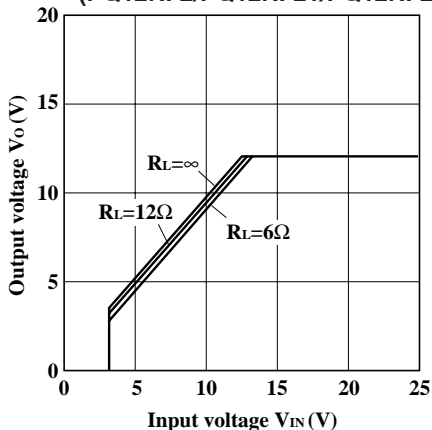

Fig.16 Output Voltage vs. Input Voltage (PQ15RF2/PQ15RF21/PQ15RF2V)

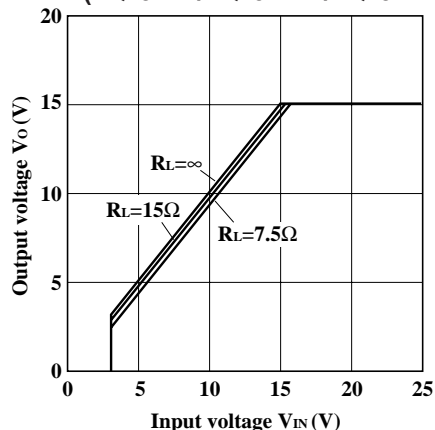

Fig.17 Circuit Operating Current vs. Input Voltage (PQ05RF2/PQ05RF21/PQ05RF2V)

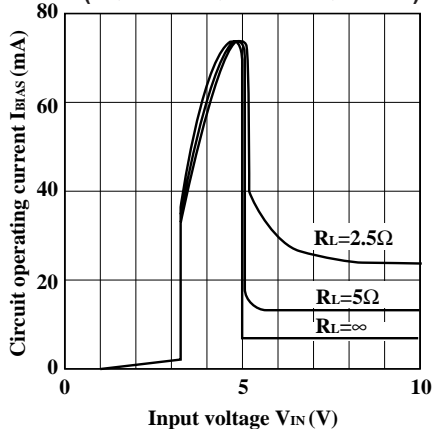

Fig.18 Circuit Operating Current vs. Input Voltage (PQ09RF2/PQ09RF21/PQ09RF2V)

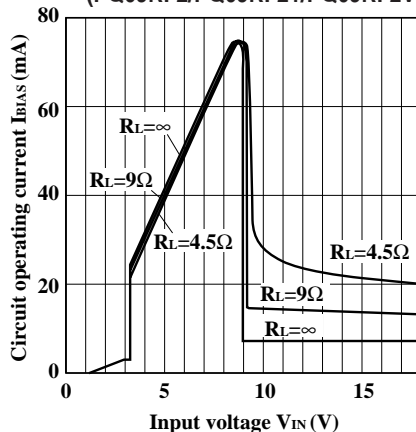

Fig.19 Circuit Operating Current vs. Input Voltage (PQ12RF2/PQ12RF21/PQ12RF2V)

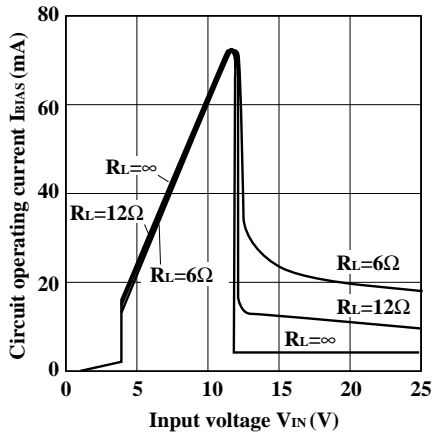

Fig.20 Circuit Operating Current vs. Input Voltage (PQ15RF2/PQ15RF21/PQ15RF2V)

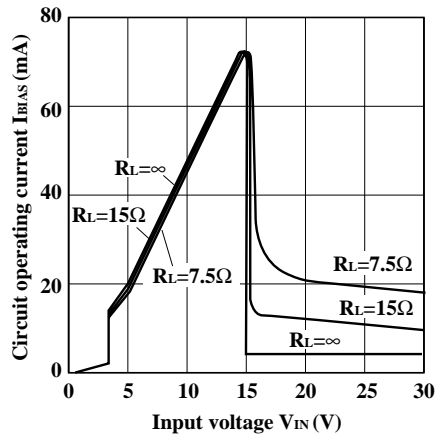

Fig.21 Dropout Voltage vs. Junction Temperature

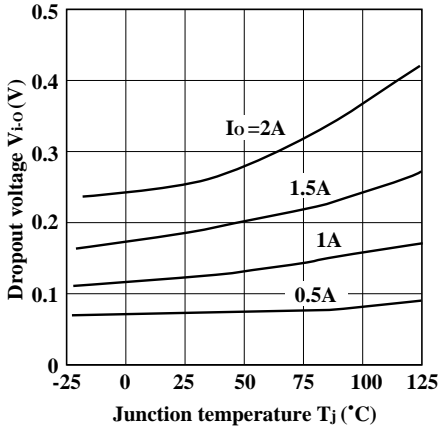

Fig.22 Quiescent Current vs. Junction Temperature

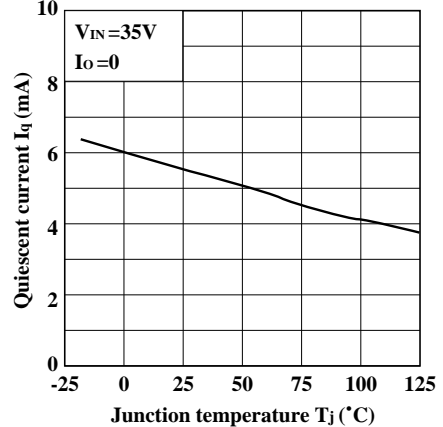

Fig.23 Ripple Rejection vs. Input Ripple Frequency (PQ05RF2/PQ05RF21/PQ09RF2/PQ09RF21/PQ12RF2/PQ12RF21/PQ15RF2/PQ15RF21)

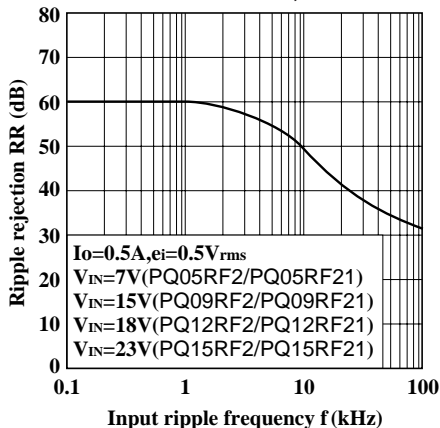

Fig.24 Ripple Rejection vs. Input Ripple Frequency (PQ05RF2V/PQ09RF2V/PQ12RF2V/PQ15RF2V)

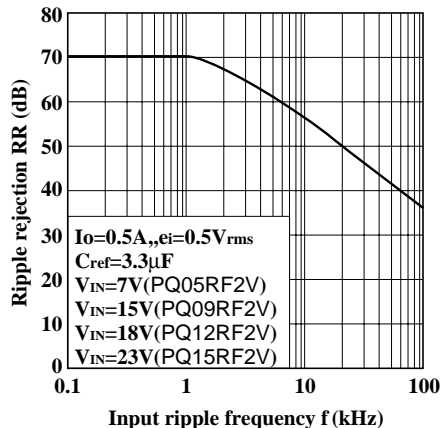
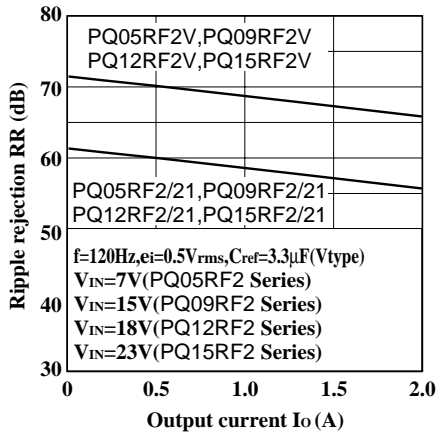
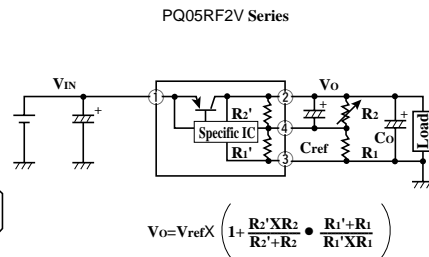
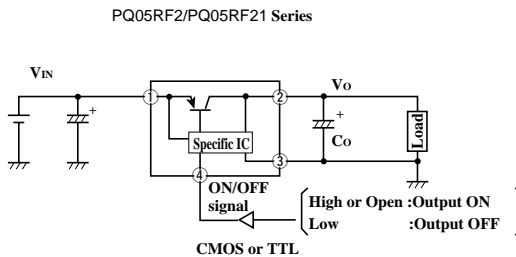

Fig.25 Ripple Rejection vs. Output Current



■ Typical Application



$V_{\text{ref}} \approx 1.26\text{V}, R_1' \approx 390\Omega$   
 PQ05RF2V :  $R_2' \approx 1.16\text{k}\Omega$   
 PQ09RF2V :  $R_2' \approx 2.40\text{k}\Omega$   
 PQ12RF2V :  $R_2' \approx 3.32\text{k}\Omega$   
 PQ15RF2V :  $R_2' \approx 4.45\text{k}\Omega$

(Note)  $R_1'$  and  $R_2'$  are built in a specific IC.

■ Model Line-ups for Lead Forming Type

Output voltage	5V Output	9V Output	12V Output	15V Output
Output voltage precision: $\pm 5\%$	PQ05RF2A	PQ09RF2A	PQ12RF2A	PQ15RF2A
Output voltage precision: $\pm 2.5\%$	PQ05RF2B	PQ09RF2B	PQ12RF2B	PQ15RF2B

■ Outline Dimensions (PQ05RF2A/PQ05RF2B Series)

(Unit : mm)

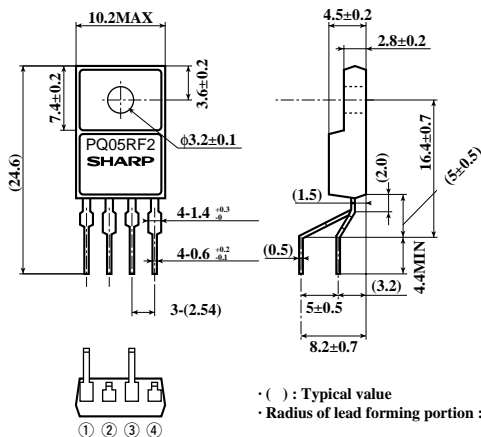

Internal connection diagram

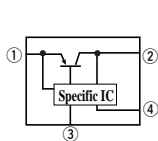

PQ05RF2/21series  
 ① DC input (V<sub>IN</sub>)  
 ② DC output (V<sub>O</sub>)  
 ③ GND  
 ④ ON/OFF control terminal (V<sub>C</sub>)

PQ05RF2Vseries  
 ① DC input (V<sub>IN</sub>)  
 ② DC output (V<sub>O</sub>)  
 ③ GND  
 ④ Output voltage minute adjustment terminal (V<sub>ADJ</sub>)

Note) The value of absolute maximum ratings and electrical characteristics is same as ones of PQ05RF2/21series.

■ Precautions for Use

(1) Minute adjustment of output voltage (PQ05RF2V series)

If the external resistor is attached to the terminals ②, ③ and ④, minute adjustment of output voltage is possible.

(Refer to the example of basic circuit (PQ05RF2V series) and Fig.5 to 8.)