

LZ9FD34

DESCRIPTION

The LZ9FD34 is a CMOS single-chip driver IC which generates timing pulses for driving 270 k/320 k/410 k/470 k-pixel B/W CCD area sensors, synchronous pulses for TV signals and processing for video signals.

FEATURES

- Designed for B/W CCD area sensors with 270 k/320 k/410 k/470 k-pixel
- Switchable between EIA and CCIR modes
- Electronic shutter and EE control are possible
- Maximum shutter speed is 1/100 000 s
- Flicker-less function
- Non-interlace mode is possible
- External synchronization is possible
- Single +5 V power supply
- Field accumulation mode and frame accumulation mode are possible
- Package :
48-pin QFP (QFP048-P-0707) 0.5 mm pin-pitch

Single-chip Driver IC for 270 k/320 k/ 410 k/470 k-pixel B/W CCDs



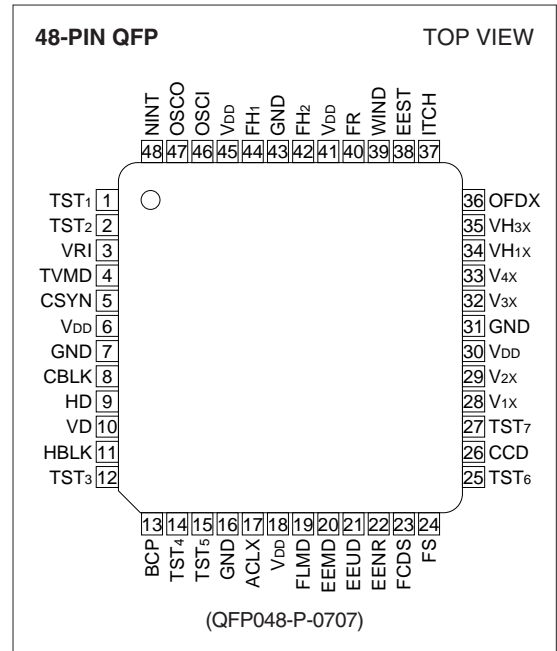

PIN CONNECTIONS

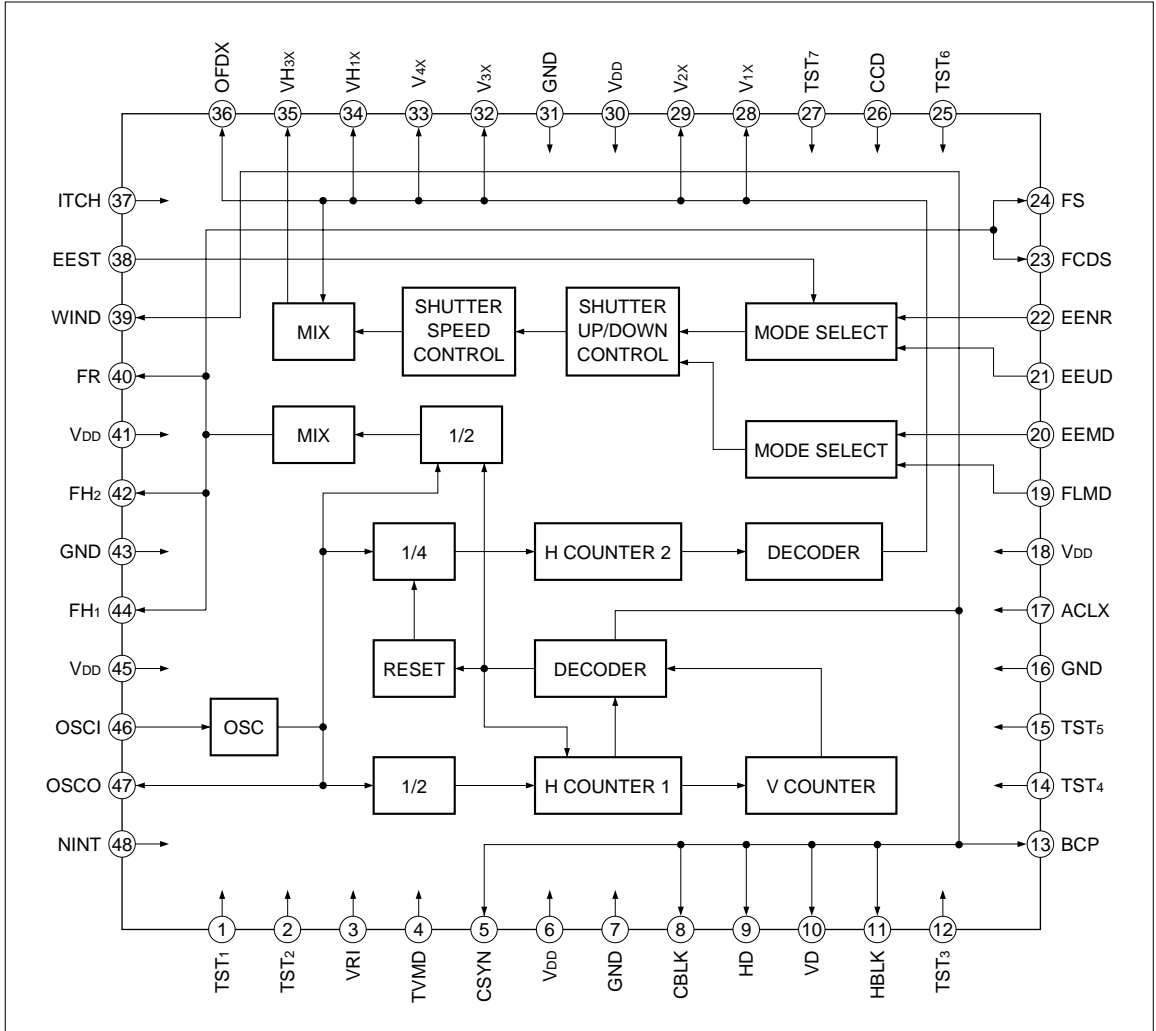







BLOCK DIAGRAM



PIN DESCRIPTION

PIN NO.	SYMBOL	I/O	POLARITY	PIN NAME	DESCRIPTION																				
1	TST1	ICD	–	Test pin 1	A test pin. Set open or to L level in the normal mode.																				
2	TST2	ICD	–	Test pin 2	A test pin. Set open or to L level in the normal mode.																				
3	VRI	ICSU	–	Vertical reset input	An input pin for resetting internal vertical counter. The input pulse is VSYNC. (negative polarity)																				
4	TVMD	ICU	–	TV mode selection input	An input pin to select TV standards. L level : EIA mode H level or open : CCIR mode																				
5	CSYN	O		Composite synchronizing pulse output	An output pin of composite synchronous signal pulse.																				
6	VDD	–	–	Power supply	Supply of +5 V power.																				
7	GND	–	–	Ground	A grounding pin.																				
8	CBLK	O		Composite blanking pulse output	An output pin of composite blanking pulse.																				
9	HD	O		Horizontal drive pulse output	The pulse occurs at the start of every line.																				
10	VD	O		Vertical drive pulse output	The pulse occurs at the start of every field.																				
11	HBLK	O		Horizontal blanking pulse output	A pulse that corresponds to the cease period of the horizontal transfer pulse.																				
12	TST3	ICD	–	Test pin 3	A test pin. Set open or to L level in the normal mode.																				
13	BCP	O		Optical black clamp pulse output	A pulse to clamp the optical black signal. This pulse stays low during the absence of effective pixels within the vertical blanking.																				
14	TST4	ICD	–	Test pin 4	A test pin. Set open or to L level in the normal mode.																				
15	TST5	ICD	–	Test pin 5	A test pin. Set open or to L level in the normal mode.																				
16	GND	–	–	Ground	A grounding pin.																				
17	ACLX	ICU	–	All clear input	An input pin for resetting all internal circuits at power on. Connect VDD through the diode and through the capacitor.																				
18	VDD	–	–	Power supply	Supply of +5 V power.																				
19	FLMD	ICU	–	Electronic exposure and WIND pulse control input 1	An input pin to control electronic exposure mode, flickerless mode and WIND (pin 39) pulse output.																				
20	EEMD	ICU	–	Electronic exposure and WIND pulse control input 2	<table border="1"> <thead> <tr> <th>FLMD</th> <th>EEMD</th> <th>Electronic Shutter mode</th> <th>WIND</th> </tr> </thead> <tbody> <tr> <td>L</td> <td>L</td> <td>EIA : 1/60 s, CCIR : 1/50 s</td> <td>WIND1</td> </tr> <tr> <td>H</td> <td>L</td> <td>EIA : 1/100 s, CCIR : 1/120 s</td> <td>WIND1</td> </tr> <tr> <td>L</td> <td>H</td> <td>Electronic exposure mode</td> <td>WIND1</td> </tr> <tr> <td>H</td> <td>H</td> <td>Electronic exposure mode</td> <td>WIND2</td> </tr> </tbody> </table>	FLMD	EEMD	Electronic Shutter mode	WIND	L	L	EIA : 1/60 s, CCIR : 1/50 s	WIND1	H	L	EIA : 1/100 s, CCIR : 1/120 s	WIND1	L	H	Electronic exposure mode	WIND1	H	H	Electronic exposure mode	WIND2
					FLMD	EEMD	Electronic Shutter mode	WIND																	
					L	L	EIA : 1/60 s, CCIR : 1/50 s	WIND1																	
					H	L	EIA : 1/100 s, CCIR : 1/120 s	WIND1																	
L	H	Electronic exposure mode	WIND1																						
H	H	Electronic exposure mode	WIND2																						
WIND1 : Vertical pulse																									
WIND2 : Composite pulse (vertical and horizontal)																									

PIN NO.	SYMBOL	I/O	POLARITY	PIN NAME	DESCRIPTION		
21	EEUD	IC	-	Electronic exposure control input 1	An input pin to control electronic exposure.		
					EEUD	EENR	Shutter Speed
					H	L	up
					H	H	control stopped
L	H	down					
22	EENR	IC	-	Electronic exposure control input 2			
23	FCDS	O4MA2		CDS pulse output 1	A pulse to clamp the feed-through level from CCD.		
24	FS	O4MA2		CDS pulse output 2	A pulse to sample-hold the signal from CCD.		
25	TST6	ICD	-	Test pin 6	A test pin. Set open or to L level in the normal mode.		
26	CCD	ICU	-	CCD selection input	An input pin to select sensor type. H level or open : 410 k, 470 k pixel CCD L level : 270 k, 320 k pixel CCD		
27	TST7	ICD	-	Test pin 7	A test pin. Set open or to L level in the normal mode.		
28	V1X	O		Vertical transfer pulse output 1	A vertical transfer pulse for CCD. Connect to V1AX pin of vertical driver IC.		
29	V2X	O		Vertical transfer pulse output 2	A vertical transfer pulse for CCD. Connect to V2AX pin of vertical driver IC.		
30	VDD	-	-	Power supply	Supply of +5 V power.		
31	GND	-	-	Ground	A grounding pin.		
32	V3X	O		Vertical transfer pulse output 3	A vertical transfer pulse for CCD. Connect to V3AX pin of vertical driver IC.		
33	V4X	O		Vertical transfer pulse output 4	A vertical transfer pulse for CCD. Connect to V4AX pin of vertical driver IC.		
34	VH1X	O		Readout pulse output	A pulse that transfers the charge of the photo-diode to the vertical shift register. Connect to VH1AX pin or VH1BX pin of vertical driver IC.		
35	VH3X	O		Readout pulse output	A pulse that transfers the charge of the photo-diode to the vertical shift register. Connect to VH3AX pin or VH3BX pin of the vertical driver IC.		
36	OFDX	O		OFD pulse output	A pulse that sweeps the charge of the photo-diode for the electronic shutter. Connect to OFD pin of CCD through the vertical driver IC and DC offset circuit. Held at H level at normal mode.		
37	ITCH	ICU	-	Accumulation mode selection input	An input pin to select accumulation mode. H level or open : Field accumulation mode L level : Frame accumulation mode		
38	EEST	ICU	-	Electronic exposure control input 3	An input pin to control electronic exposure using EEUD (pin 21) and EENR (pin 22). H level or open : Electronic exposure is operated. L level : Electronic exposure is stopped.		

PIN NO.	SYMBOL	I/O	POLARITY	PIN NAME	DESCRIPTION													
39	WIND	ON (N-ch Open Drain)		Window pulse output	An output pin for window pulse. <table border="1" data-bbox="714 195 1226 366"> <thead> <tr> <th>EEMD</th> <th>FLMD</th> <th>WIND</th> </tr> </thead> <tbody> <tr> <td>L</td> <td>L</td> <td rowspan="2">WIND1 (vertical pulse)</td> </tr> <tr> <td>L</td> <td>H</td> </tr> <tr> <td>H</td> <td>L</td> <td rowspan="2">WIND2 (composite pulse)</td> </tr> <tr> <td>H</td> <td>H</td> </tr> </tbody> </table>	EEMD	FLMD	WIND	L	L	WIND1 (vertical pulse)	L	H	H	L	WIND2 (composite pulse)	H	H
					EEMD	FLMD	WIND											
L	L	WIND1 (vertical pulse)																
L	H																	
H	L	WIND2 (composite pulse)																
H	H																	
					<p>WIND1 : When connected to EEST (pin 38), the operation of electronic exposure can be stopped at the upper side of monitor.</p> <p>WIND2 : A pulse that picks out the center of CCD output. At this time, set H level or open at EEST (pin 38). As the output circuit of WIND is N-ch open drain, connect to VDD with R ($\geq 47 \text{ k}\Omega$).</p>													
40	FR	O4MA3		Reset pulse output	A pulse to reset the charge of output circuit. Connect to ϕ_R pin of CCD through the DC offset circuit.													
41	VDD	-	-	Power supply	Supply of +5 V power.													
42	FH ₂	O4MA3		Horizontal transfer pulse output 2	A pulse to drive horizontal CCD shift register. Connect to ϕ_{H2} pin of CCD.													
43	GND	-	-	Ground	A grounding pin.													
44	FH ₁	O4MA3		Horizontal transfer pulse output 1	A pulse to drive horizontal CCD shift register. Connect to ϕ_{H1} pin of CCD.													
45	VDD	-	-	Power supply	Supply of +5 V power.													
46	OSCI	OSCI	-	Clock input	An input pin for reference clock oscillation. Connect to OSCO (pin 47) with R. The frequencies are as follows :													
					<table border="1" data-bbox="714 1012 1226 1183"> <thead> <tr> <th>TVMD</th> <th>CCD</th> <th>Frequency</th> </tr> </thead> <tbody> <tr> <td>L</td> <td>L</td> <td>19.0699 MHz (1 212 fH)</td> </tr> <tr> <td>L</td> <td>H</td> <td>28.6364 MHz (1 820 fH)</td> </tr> <tr> <td>H</td> <td>L</td> <td>19.3125 MHz (1 236 fH)</td> </tr> <tr> <td>H</td> <td>H</td> <td>28.3750 MHz (1 816 fH)</td> </tr> </tbody> </table> <p>fH = Horizontal frequency</p>	TVMD	CCD	Frequency	L	L	19.0699 MHz (1 212 fH)	L	H	28.6364 MHz (1 820 fH)	H	L	19.3125 MHz (1 236 fH)	H
TVMD	CCD	Frequency																
L	L	19.0699 MHz (1 212 fH)																
L	H	28.6364 MHz (1 820 fH)																
H	L	19.3125 MHz (1 236 fH)																
H	H	28.3750 MHz (1 816 fH)																
47	OSCO	OSC3M	-	Clock output	An output pin for reference clock oscillation. The output is the inverse of OSCI (pin 46).													

PIN NO.	SYMBOL	I/O	POLARITY	PIN NAME	DESCRIPTION									
48	NINT	ICD	—	Non-interlace selection input	An input pin to select non-interlace mode. L level or open : Interlace mode H level : Non-interlace mode Period of field (at non-interlace mode) <table border="1"> <thead> <tr> <th>TVMD</th> <th>Field</th> <th>Number of Line</th> </tr> </thead> <tbody> <tr> <td>L</td> <td>ODD</td> <td>262H</td> </tr> <tr> <td>H</td> <td>1st</td> <td>312H</td> </tr> </tbody> </table>	TVMD	Field	Number of Line	L	ODD	262H	H	1st	312H
TVMD	Field	Number of Line												
L	ODD	262H												
H	1st	312H												

IC : Input pin (CMOS level)

ICU : Input pin (CMOS level with pull-up resistor)

ICSU : Input pin (CMOS schmitt-trigger level with pull-up resistor)

ICD : Input pin (CMOS level with pull-down resistor)

O : Output pin

O4MA2 : Output pin

O4MA3 : Output pin

ON : Output pin (N-ch open drain)

OSCI : Input pin for oscillation

OSC3M : Output pin for oscillation

SUPPLEMENTARY EXPLANATION

Shutter speed changes at electronic exposure control mode.

EIA			CCIR		
No.	Charge Time	Shutter Speed	No.	Charge time	Shutter Speed
0	262H or 263H	$\cong 1/60$ s	0	312H or 313H	$\cong 1/50$ s
1	$252H + \alpha$	$\cong 1/62$ s	1	$302H + \beta$	$\cong 1/52$ s
•	(by 10H step)		•	(by 10H step)	
19	$72H + \alpha$	$\cong 1/220$ s	24	$72H + \beta$	$\cong 1/220$ s
•	(by 4H step)		•	(by 4H step)	
30	$28H + \alpha$	$\cong 1/555$ s	35	$28H + \beta$	$\cong 1/550$ s
•	(by 2H step)		•	(by 2H step)	
37	$14H + \alpha$	$\cong 1/1100$ s	42	$14H + \beta$	$\cong 1/1090$ s
•	(by 1H step)		•	(by 1H step)	
44	$7H + \alpha$	$\cong 1/2140$ s	49	$7H + \beta$	$\cong 1/2125$ s
•	(by 0.5H step)		•	(by 0.5H step)	
50	$4H + \alpha$	$\cong 1/3610$ s	55	$4H + \beta$	$\cong 1/3590$ s
•	(by 0.25H step)		•	(by 0.25H step)	
62	$1H + \alpha$	$\cong 1/11570$ s	67	$1H + \beta$	$\cong 1/11550$ s
•	(by 0.125H step)		•	(by 0.125H step)	
69	$0.125H + \alpha$	$\cong 1/32450$ s	74	$0.125H + \beta$	$\cong 1/32690$ s
70	0.280H	$\cong 1/56090$ s	75	0.275H	$\cong 1/56800$ s
71	0.155H	$\cong 1/101430$ s	76	0.152H	$\cong 1/102720$ s

$$\alpha = 0.360H$$

$$\beta = 0.353H$$

ABSOLUTE MAXIMUM RATINGS

PARAMETER	SYMBOL	RATING	UNIT
Supply voltage	V _{DD}	-0.3 to +6.0	V
Input voltage	V _I	-0.3 to V _{DD} + 0.3	V
Output voltage	V _O	-0.3 to V _{DD} + 0.3	V
Operating temperature	T _{OPR}	-30 to +70	°C
Storage temperature	T _{STG}	-55 to +150	°C

ELECTRICAL CHARACTERISTICS

DC Characteristics

(V_{DD} = 5.0±0.5 V, T_{OPR} = -30 to +70 °C)

PARAMETER	SYMBOL	CONDITIONS	MIN.	TYP.	MAX.	UNIT	NOTE
Input "Low" voltage	V _{IL}				1.5	V	1
Input "High" voltage	V _{IH}		3.5			V	
Input "Low" voltage	V _{T+}				3.7	V	2
Input "High" voltage	V _{T-}		1.0			V	
Hysteresis voltage	V _{T+} - V _{T-}		0.2			V	
Input "Low" current	I _{IL1}	V _I = 0 V			2.0	μA	3
Input "High" current	I _{IH1}	V _I = V _{DD}			2.0	μA	
Input "Low" current	I _{IL2}	V _I = 0 V	8.0		75	μA	4
Input "High" current	I _{IH2}	V _I = V _{DD}			2.0	μA	
Input "Low" current	I _{IL3}	V _I = 0 V			2.0	μA	5
Input "High" current	I _{IH3}	V _I = V _{DD}	8.0		75	μA	
Output "Low" voltage	V _{OL1}	I _{OL} = 3 mA			0.4	V	6
Output "High" voltage	V _{OH1}	I _{OH} = -3 mA	4.0			V	
Output "Low" voltage	V _{OL2}	I _{OL} = 4 mA			0.4	V	7
Output "High" voltage	V _{OH2}	I _{OH} = -2 mA	4.0			V	
Output "Low" voltage	V _{OL3}	I _{OL} = 8 mA			0.4	V	8
Output "High" voltage	V _{OH3}	I _{OH} = -6 mA	4.0			V	
Output "Low" voltage	V _{OL4}	I _{OL} = 12 mA			0.4	V	9
Output "High" voltage	V _{OH4}	I _{OH} = -9 mA	4.0			V	
Output "Low" voltage	V _{OL5}	I _{OL} = 4 mA			0.4	V	10
Output leakage current	I _{OZ}	High-Z			1.0	μA	

NOTES :

1. Applied to inputs (IC, ICD, ICU, OSC1).
2. Applied to input (ICSU).
3. Applied to inputs (IC, OSC1).
4. Applied to inputs (ICU, ICSU).
5. Applied to input (ICD).
6. Applied to output (OSC3M). (Output (OSC3M) measures on condition that input (OSCI) level is 0 V or V_{DD}.)
7. Applied to output (O).
8. Applied to output (O4MA2).
9. Applied to output (O4MA3).
10. Applied to output (ON).

PACKAGE

(Unit : mm)

48 QFP (QFP048-P-0707)

