

# GL560/GL561

## Low Peak Forward Voltage Type φ 5 Resin Mold Package Infrared Emitting Diodes

### ■ Features

1. Low peak forward voltage suitable for battery drive  
( $V_{FM}$  : TYP.1.7V at  $I_{FM}$  : 0.5A)
2. φ 5 resin mold package

### ■ Applications

1. Infrared remote controllers for TVs, VCRs,  
audio equipment and air conditioners

### ■ Model Lineup

Model	GL560	GL561
Radiant intensity TYP. (mW/sr)	14	25
Half intensity angle TYP. (°)	± 21	± 13

### ■ Absolute Maximum Ratings

(Ta=25°C)

Parameter	Symbol	Rating	Unit
Forward current	$I_F$	100	mA
*1 Peak forward current	$I_{FM}$	1	A
Reverse voltage	$V_R$	6	V
Power dissipation	P	150	mW
Operating temperature	$T_{opr}$	- 25 to + 85	°C
*2 Storage temperature	$T_{stg}$	- 40 to + 85	°C
Soldering temperature	$T_{sol}$	260	°C

\*1 Pulse width &lt;=100μs, Duty ratio=0.01

\*2 For 10 seconds at the position of 2.6 mm from the resin edge

### ■ Electro-optical Characteristics

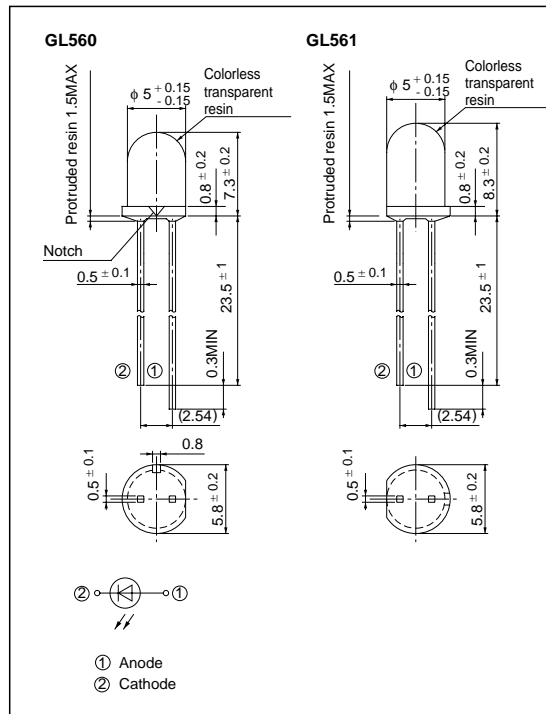
(Ta=25°C)

Parameter	Symbol	Conditions	MIN.	TYP.	MAX.	Unit
Forward voltage	$V_F$	$I_F = 50\text{mA}$	-	1.25	1.37	V
Peak forward voltage	$V_{FM}$	$I_{FM} = 0.5\text{A}$	-	1.7	2.5	V
Reverse current	$I_R$	$V_R = 3\text{V}$	-	-	10	μA
*3 Radiant intensity	GL560	$I_F = 50\text{mA}$	5	14	-	mW/sr
	GL561		12	25	-	
Peak emission wavelength	$\lambda_p$	$I_F = 5\text{mA}$	-	940	-	nm
Half intensity wavelength	$\Delta\lambda$	$I_F = 5\text{mA}$	-	45	-	nm
Terminal capacitance	$C_t$	$V_R = 0, f = 1\text{MHz}$	-	50	-	pF
Response frequency	fc	-	-	300	-	kHz
Half intensity angle	GL560	$I_F = 20\text{mA}$	-	± 21	-	°
	GL561		-	± 13	-	

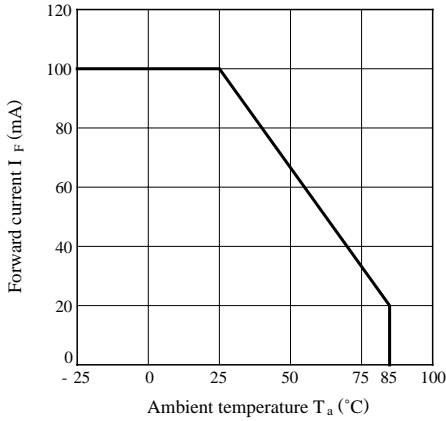
\*3  $I_E$  : Value obtained by converting the value in power of radiant fluxes emitted at the solid angle of 0.01 sr (steradian) in the direction of mechanical axis of the lens portion into 1 sr or all those emitted from the light emitting diode.

### ■ Outline Dimensions

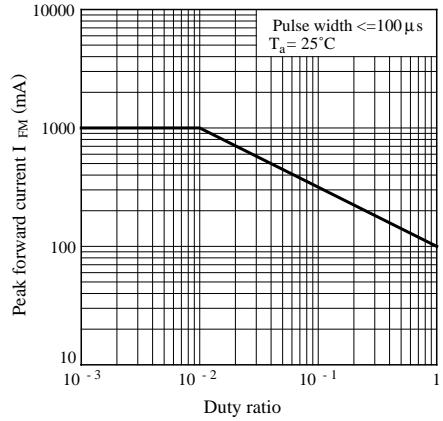
(Unit : mm)



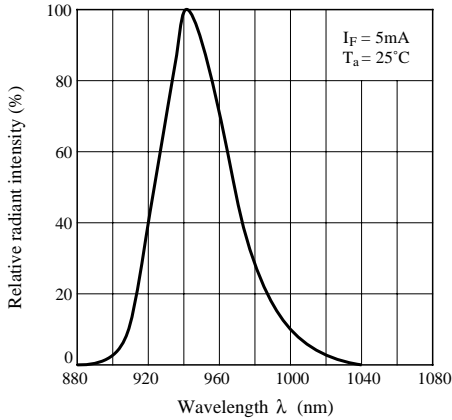
**Fig. 1 Forward Current vs. Ambient Temperature**



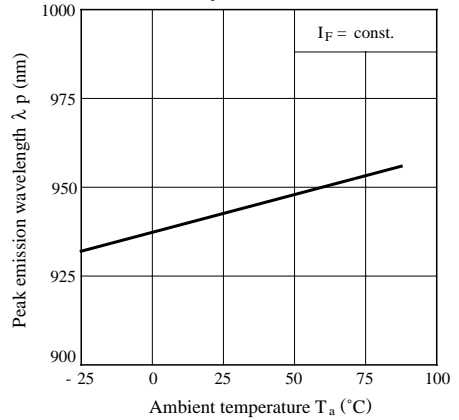
**Fig. 2 Peak Forward Current vs. Duty Ratio**



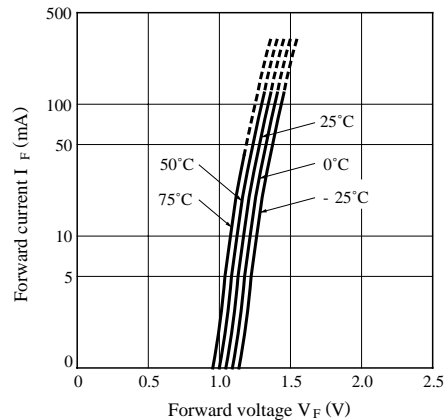
**Fig. 3 Spectral Distribution**



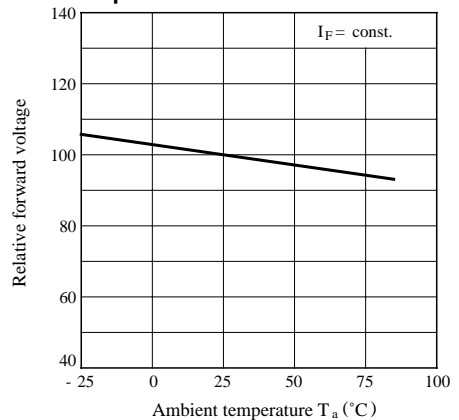
**Fig. 4 Peak Emission Wavelength vs. Ambient Temperature**



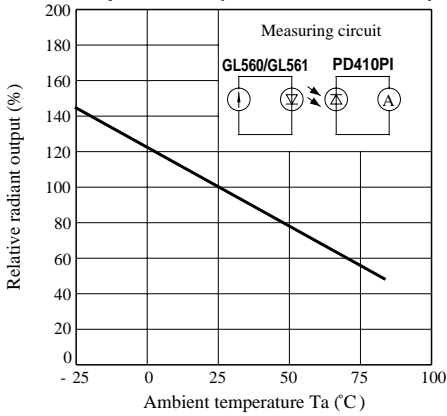
**Fig. 5 Forward Current vs. Forward Voltage**



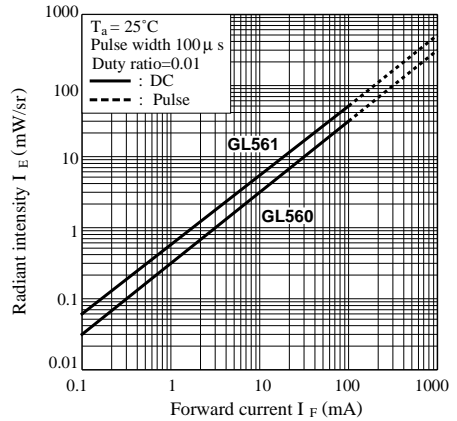
**Fig. 6 Relative Forward Voltage vs. Ambient Temperature**



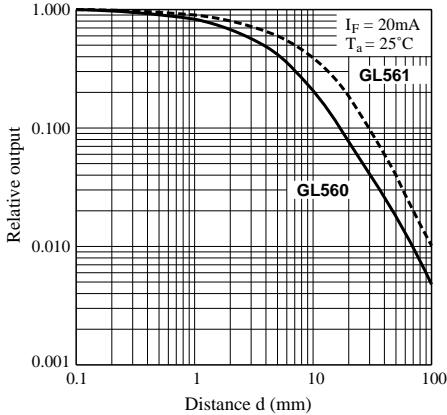
**Fig. 7 Relative Radiant Output vs. Ambient Temperature (Detector : PD410PI)**



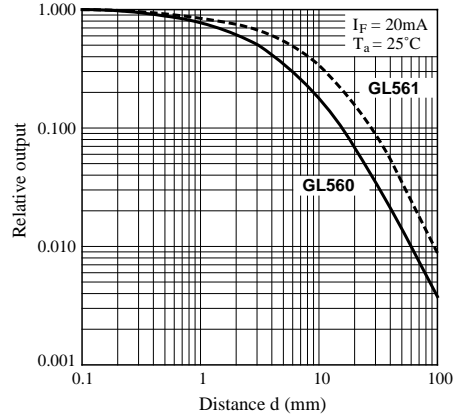
**Fig. 8 Radiant Intensity vs. Forward Current**



**Fig. 9 Relative Output vs. Distance (Detector : PD410PI)**

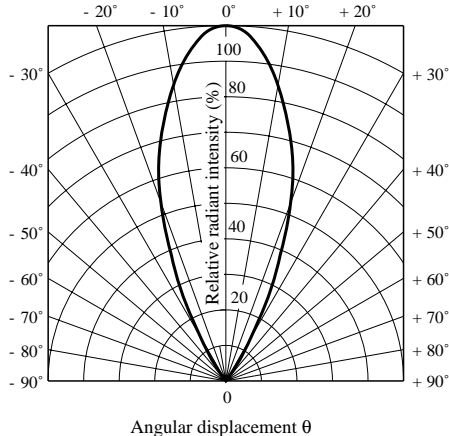


**Fig. 10 Relative Output vs. Distance (Detector : PD49PI)**



**Fig. 11-a Radiation Diagram (GL560)**

( $T_a = 25^\circ\text{C}$ )



**Fig. 11-b Radiation Diagram (GL561)**

( $T_a = 25^\circ\text{C}$ )

