

# GP1A75E

## Small Size OPIC Photointerrupter with Connector

### ■ Features

1. 3-pin connector terminal
2. High sensing accuracy  
(Slit width: 0.5mm)
3. Wide gap between light emitter and detector (5mm)

### ■ Applications

1. Copiers
2. Laser beam printers
3. Facsimiles

### ■ Outline Dimensions

(Unit : mm)

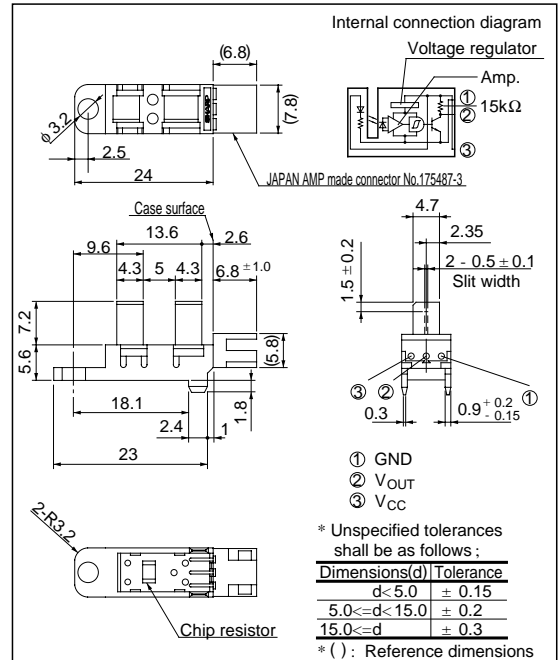

\*\*"OPIC" (Optical IC) is a trademark of the SHARP Corporation.

An OPIC consists of a light-detecting element and signal-processing circuit integrated onto a single chip.

### ■ Absolute Maximum Ratings (Ta= 25°C)

Parameter	Symbol	Rating	Unit
Supply voltage	V <sub>CC</sub>	- 0.5 to + 10	V
*1 Low level output current	I <sub>OL</sub>	50	mA
*2 Operating temperature	T <sub>opr</sub>	- 20 to + 75	°C
*2 Storage temperature	T <sub>stg</sub>	- 30 to + 85	°C

\*1 Collector current of output transistor

\*2 The connector should be plugged in/out and the unit's hook should be used at normal temperature.

■ Electro-optical Characteristics

(Unless otherwise specified,  $V_{CC} = 5V, T_a = 25^\circ C$ )

Parameter		Symbol	Conditions	MIN.	TYP.	MAX.	Unit
Operating supply voltage		$V_{CC}$	-	4.5	-	5.5	V
Low level supply current		$I_{CCL}$	Light beam interrupted	-	-	20	mA
Low level output voltage		$V_{OL}$	Light beam interrupted, $I_{OL} = 16mA$	-	-	0.35	V
High level supply current		$I_{CCH}$	Light beam uninterrupted	-	-	20	mA
High level output voltage		$V_{OH}$	Light beam uninterrupted	$V_{CC} \times 0.9$	-	-	V
Response characteristics	Minimum interruption time	$t_H$	-	166	-	-	$\mu s$
	Minimum sensing time	$t_L$	-	166	-	-	$\mu s$

Fig. 1 Low Level Output Current vs. Ambient Temperature

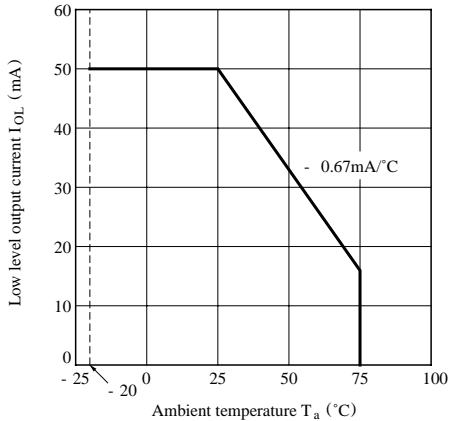

Fig. 2 Low Level Output Voltage vs. Low Level Output Current

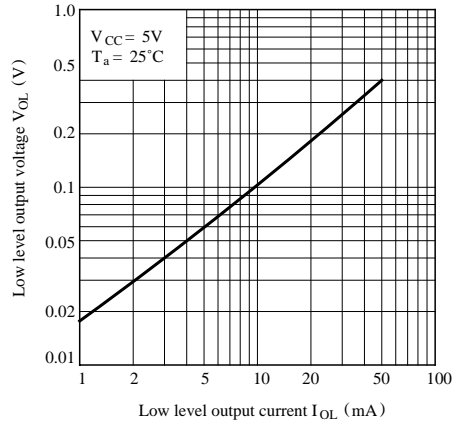

Fig. 3 Low Level Output Voltage vs. Ambient Temperature

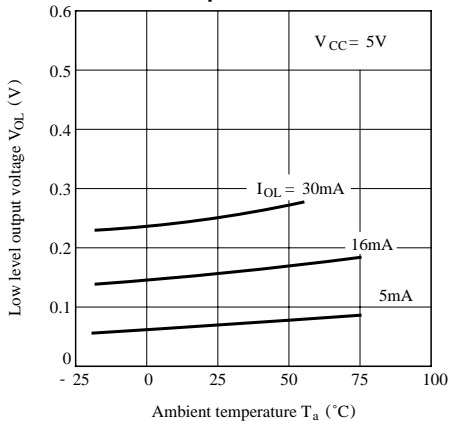

Fig. 4 Supply Current vs. Supply Voltage

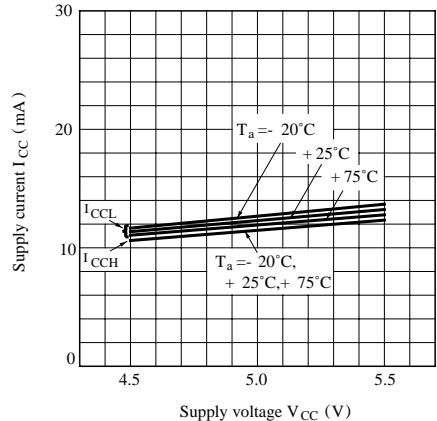

Fig. 5 Detecting Position Characteristics (1)

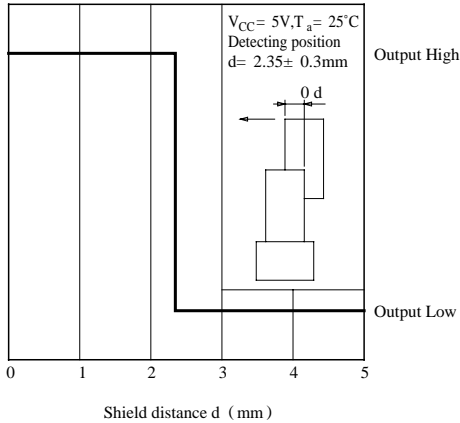
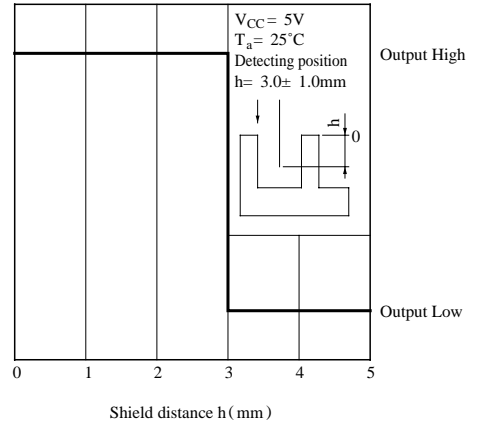
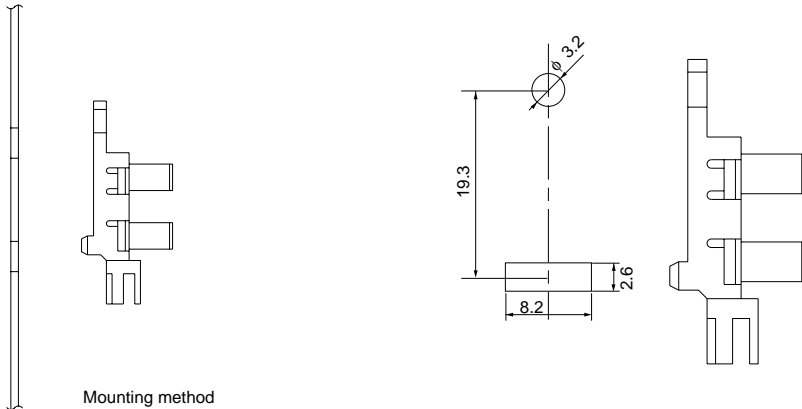

Fig. 6 Detecting Position Characteristics (2)



### ■ Recommended Mounting Holes (Unit : mm)



### ■ Precautions for Use

- (1) In this product, the PWB is fixed with a hook, and cleaning solvent may remain inside the case; therefore, dip cleaning or ultrasonic cleaning are prohibited.
- (2) Remove dust or stains, using an air blower or a soft cloth moistened in cleaning solvent. In this case, use only the following type of cleaning solvent used for wiping off:  
Ethyl alcohol, Methyl alcohol, Isopropyl alcohol  
When the cleaning solvents except for specified materials are used, please consult us.
- (3) In order to stabilize power supply line, connect a by-pass capacitor of more than  $0.01\mu F$  between  $V_{CC}$  and GND near the device.
- (4) As for other general cautions, refer to the chapter“Precautions for Use”.