

GP1U78R Series

IR Detecting Unit For Remote Control

■ Features

1. Less sensitive to fluorescent lamp driven by inverter.
2. Improved anti-electromagnetic noise characteristic by mesh type light detecting window.
3. Various B.P.F (Band Pass Filter) frequency

■ Applications

1. TVs
2. VCRs
3. CATV set top boxes
4. BS receivers

■ Outline Dimensions

(Unit : mm)

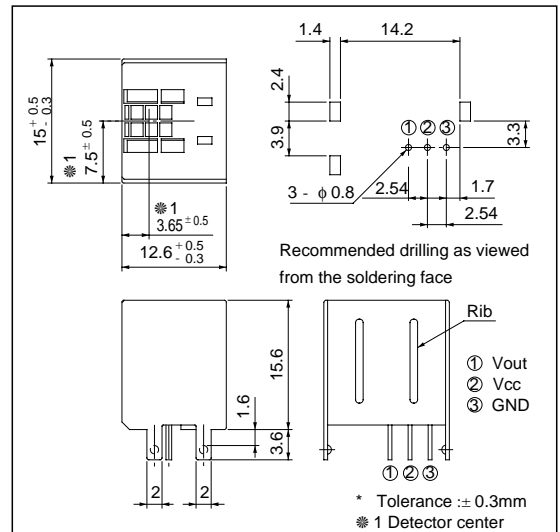

■ Absolute Maximum Ratings (Ta = 25°C)

Parameter	Symbol	Rating	Unit
Supply voltage	V _{CC}	0 to 6.3	V
*1 Operating temperature	T _{opr}	- 10 to +70	°C
Storage temperature	S _{stg}	- 20 to +70	°C
*2 Soldering temperature	T _{sol}	260	°C

*1 No dew formation

*2 For 5 seconds

■ Recommended Operations Conditions

Parameter	Symbol	Value	Unit
Supply voltage	V _{CC}	4.7 to 5.3	V

■ Electrical Characteristics

(Ta = 25°C, V_{CC} = +5V)

Parameter	Symbol	Conditions	MIN.	TYP.	MAX.	Unit
Dissipation current	I _{CC}	No input light	-	-	5.0	mA
High level output voltage	V _{OH}	*3	V _{CC} - 0.5	-	-	V
Low level output voltage	V _{OL}		-	-	0.45	V
High level pulse width	T ₁		400	-	800	μs
Low level pulse width	T ₂		400	-	800	
B. P. F. center frequency	f _o	-	-	*440	-	kHz

*3 The burst wave as shown in the following figure shall be transmitted by the transmitter shown in Fig. 1.

*4 Diversified models with a different B. P. F. frequency, as shown in a separate table, are also available.

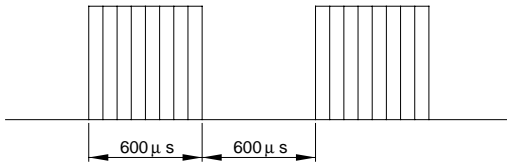

The value of f_0 is shown in a separate table.
Duty 50%

Model Line-up

Model No.	B.P.F. frequency	Unit
GP1U78R	40	kHz
GP1U780R	36	
GP1U781R	38	
GP1U782R	36.7	
GP1U783R	32.75	
GP1U787R	56.8	

Internal Block Diagram

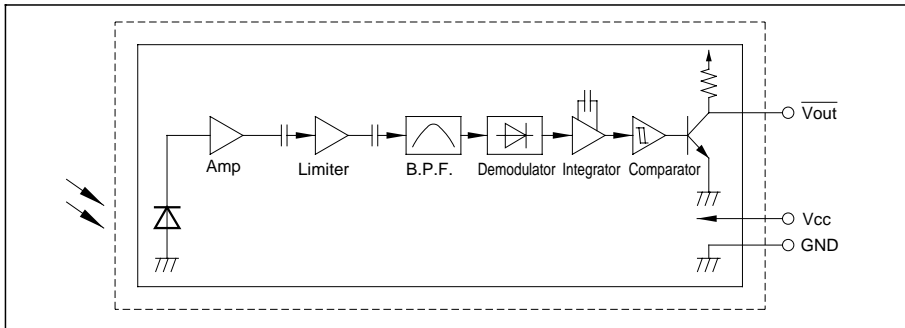

■ Performance

Using the transmitter shown in Fig. 1, the output signal of the light detecting unit is good enough to meet the following items in the standard optical system in Fig. 2.

(1) Linear reception distance characteristics

When $L=0.2$ to 6.5m , $E_e < 10\text{ lx}$ and $\phi = 0^\circ$ in Fig. 2, the output signal shall meet the electrical characteristics in the attached list.

(2) Sensitivity angle reception distance characteristics

When $L=0.2$ to 4.5m , $E_e < 10\text{ lx}$ and $\phi \leq 30^\circ$ in Fig. 2, the output signal shall meet the electrical characteristics in the attached list.

(3) Anti outer peripheral light reception distance characteristics

When $L=0.2$ to 3m , $E_e \leq 300\text{ lx}$ and $\phi = 0^\circ$ in Fig. 2, the output signal shall meet the electrical characteristics in the attached list.

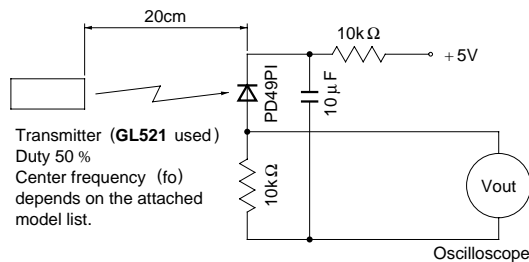

Fig. 1. Transmitter

In the above figure, the transmitter should be set so that the output V_{out} can be 40mV_{PP} .

However, the **PD49PI** to be used here should be of the short-circuit current $I_{SC} = 2.6\ \mu\text{ A}$ at $E_v = 100\text{ lx}$.

(E_v is an illuminance by CIE standard light source A (tungsten lamp).)

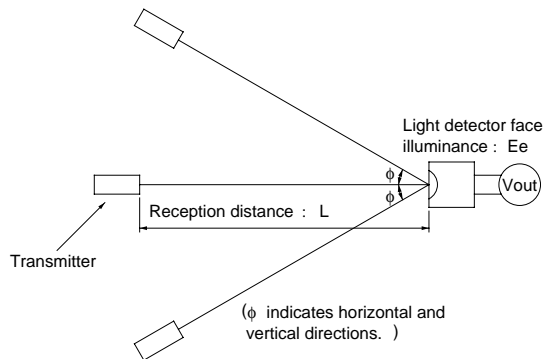

Fig. 2. Standard optical system

■ Precautions for Use

- (1) Use the light emitting unit (remote control transmitter), in consideration of performance, characteristics and operating condition of light emitting device and the characteristics of the light detecting unit.
 - (2) Pay attention to a malfunction of the light detecting unit when the surface is stained with dust and refuse. Care must be taken not to touch the light detector surface. If it should be dirty, wipe off with soft cloth so as to prevent scratch. In case some solvents are required, use methyl alcohol, ethyl alcohol or isopropyl alcohol. Also, protect the light detecting unit against flux and others.
 - (3) The shield case shall be grounded on PWB pattern.
 - (4) Do not apply unnecessary force to the terminals and case form outside.
 - (5) Do not push the light detector surface (photodiode) from outside.
 - (6) To avoid the electrostatic breakdown of IC, handle the unit under the condition of grounding with human body, soldering iron, etc.
 - (7) In case of adopting the infrared light detecting unit for the wireless remote control, use it in accordance with the transmission scheme and the signal format recommended in “Countermeasures for malfunction prevention of home appliances with infrared remote control” issued from Japan Association of Electrical Home Appliances (AEHA) in July 1987.
 - (8) As for other general cautions, refer to the chapter “Precautions for Use” (Page 78 to 93).
-