

GP2L09/GP2L24 GP2L26

Subminiature, High Sensitivity Photointerrupter

■ Features

1. Compact and thin
GP2L09: Compact DIP, long lead type
GP2L24: Compact DIP type
GP2L26: Flat lead type
2. Optimum detection distance: 0.6 to 0.8mm
3. High sensitivity
 (I_C: MIN. 0.5mA at I_F= 4mA)
4. Visible light cut-off type

■ Applications

1. Cassette tape recorders, VCRs
2. Floppy disk drives
3. Various microcomputerized control equipment

■ Outline Dimensions

(Unit : mm)

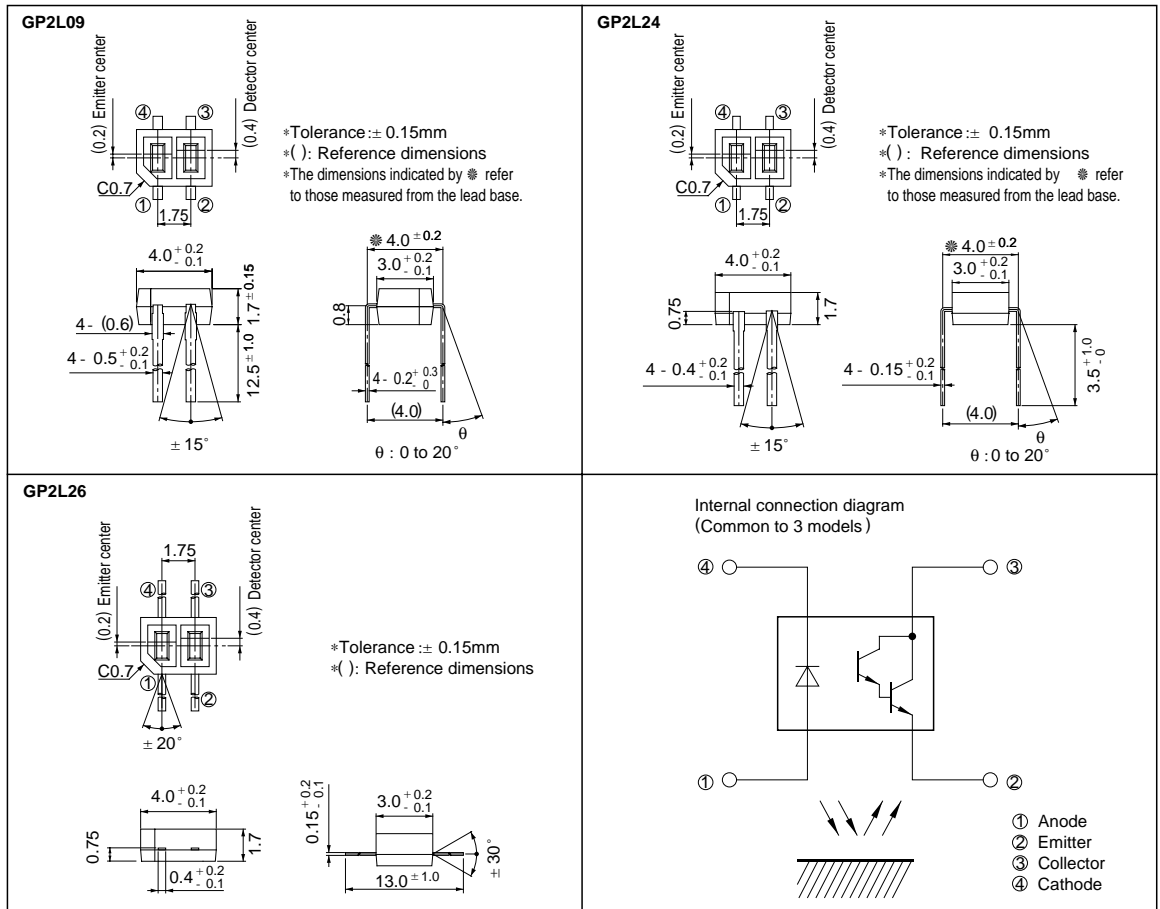

Absolute Maximum Ratings

(Ta = 25°C)

	Parameter	Symbol	Rating	Unit
Input	Forward current	I _F	50	mA
	Reverse voltage	V _R	6	V
	Power dissipation	P	75	mW
Output	Collector-emitter voltage	V _{CEO}	35	V
	Emitter-collector voltage	V _{ECO}	6	V
	Collector current	I _C	50	mA
	Collector power dissipation	P _C	75	mW
	Total power dissipation	P _{tot}	100	mW
	Operating temperature	T _{opr}	- 25 to + 85	°C
	Storage temperature	T _{stg}	- 40 to + 100	°C
	*1 Soldering temperature	T _{sol}	260	°C

*1 Within 5 seconds (Soldering areas for each model are shown below.)

GP2L09, GP2L24

Soldering area

The hatched area more than 1mm^{*2} away from the lower edge of package as shown in the drawing below.

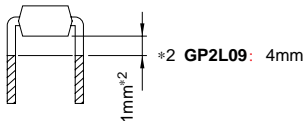

GP2L26

Soldering area

The hatched area more than 2.0mm away from the both edge of package as shown in the drawing below.

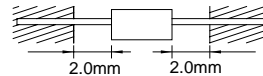

Electro-optical Characteristics

(Ta = 25°C)

	Parameter	Symbol	Conditions	MIN.	TYP.	MAX.	Unit	
Input	Forward voltage	I _F	I _F = 20mA	-	1.2	1.4	V	
	Reverse current	I _R	V _R = 6V	-	-	10	μA	
Output	Collector dark current	I _{CEO}	V _{CE} = 10V, I _F = 0	-	-	1 × 10 ⁻⁶	A	
Transfer-characteristics	*3 Collector current	I _C	V _{CE} = 2V, I _F = 4mA	0.5	3.0	15.0	mA	
	Response time	Rise time	t _r	V _{CE} = 2V, I _C = 10mA R _L = 100Ω, d = 1mm	-	80	400	μs
		Fall time	t _f		-	70	400	μs
	*4 Leak current	I _{LEAK}	I _F = 4mA, V _{CE} = 5V	-	-	5.0	μA	

*3 The condition and arrangement of the reflective object are shown in the right drawing.

*4 Without reflective object

The ranking of collector current shall be classified into the following 6 ranks.

(GP2L09, GP2L24, GP2L26)

Rank	Collector current I _C (mA)
*5 A	0.5 to 1.9
B	1.45 to 5.4
C	4.0 to 15.0
A or B	0.5 to 5.4
B or C	1.45 to 15.0
A, B or C	0.5 to 15.0

*5 GP2L24 and GP2L26 don't have A rank.

Test Condition for Collector Current

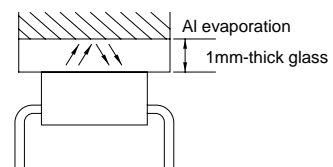

Fig. 1 Forward Current vs. Ambient Temperature

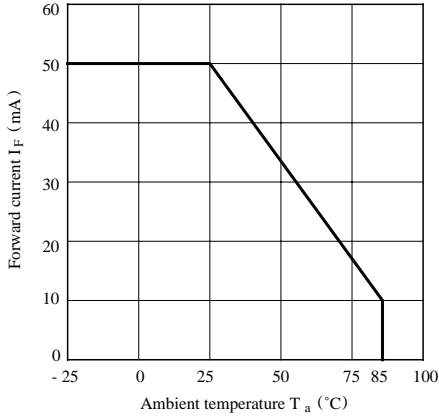

Fig. 2 Power Dissipation vs. Ambient Temperature

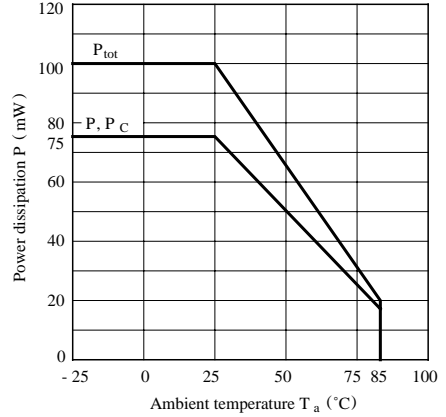

Fig. 3 Peak Forward Current vs. Duty Ratio

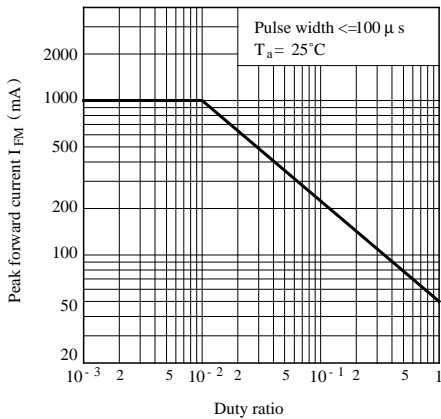

Fig. 4 Forward Current vs. Forward Voltage

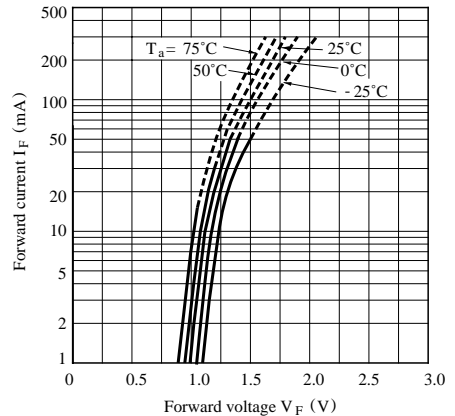

Fig. 5 Collector Current vs. Forward Current

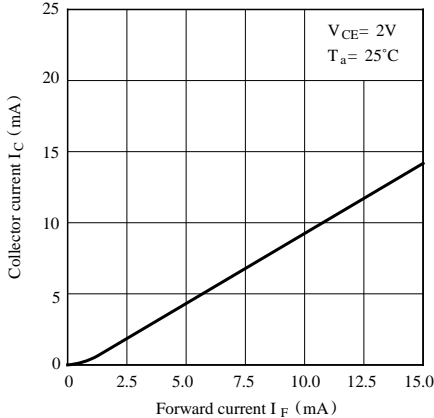

Fig. 6 Collector Current vs. Collector-emitter Voltage

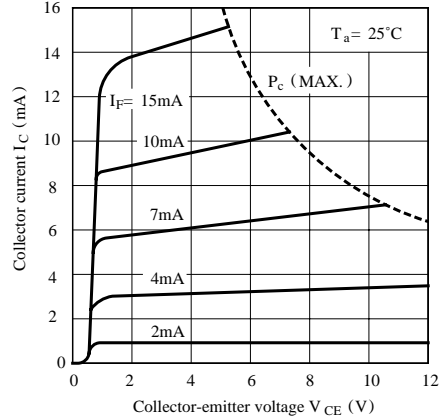

Fig. 7 Relative Collector Current vs. Ambient Temperature

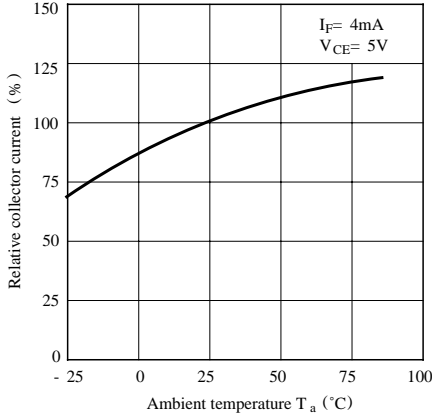

Fig. 8 Collector Dark Current vs. Ambient Temperature

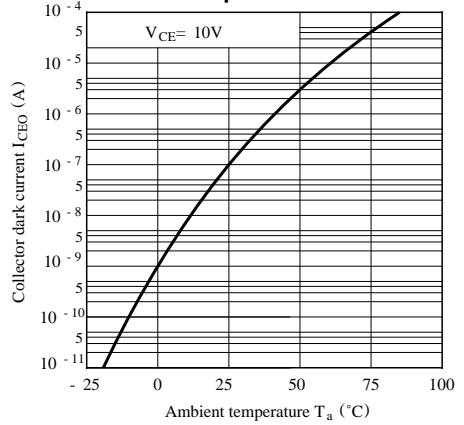

Fig. 9-a Response Time vs. Load Resistance (GP2L09)

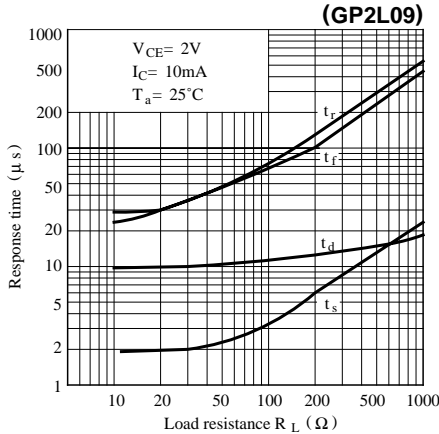
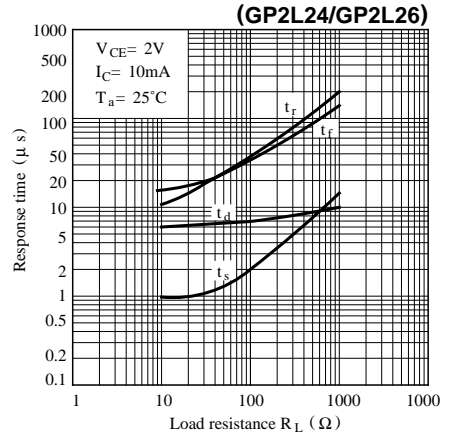

Fig. 9-b Response Time vs. Load Resistance (GP2L24/GP2L26)



Test Circuit for Response Time

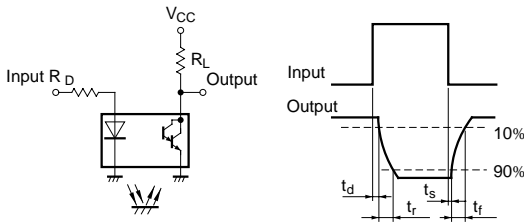

Fig.10 Relative Collector Current vs. Distance between Sensor and Al Evaporation Glass

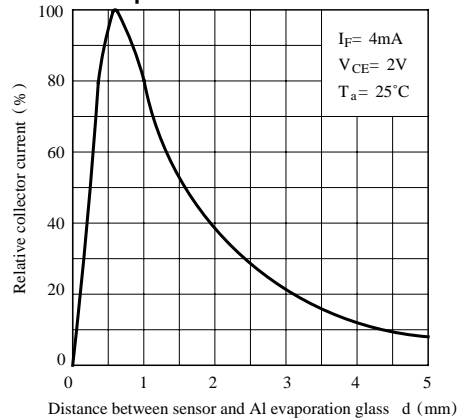

Fig.11 Relative Collector Current vs. Card Moving Distance (1)

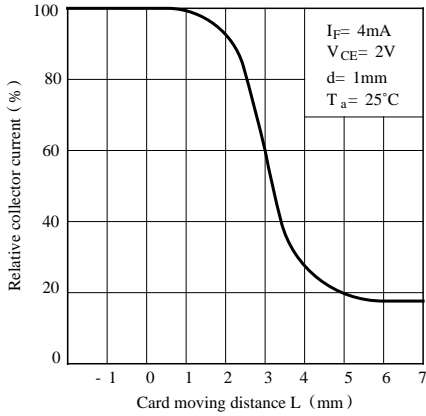
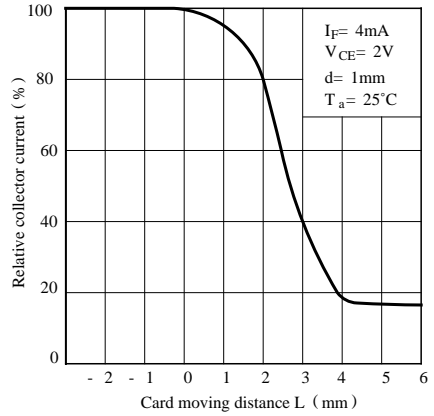

Fig.12 Relative Collector Current vs. Card Moving Distance (2)



Test Condition for Distance & Detecting Position Characteristics

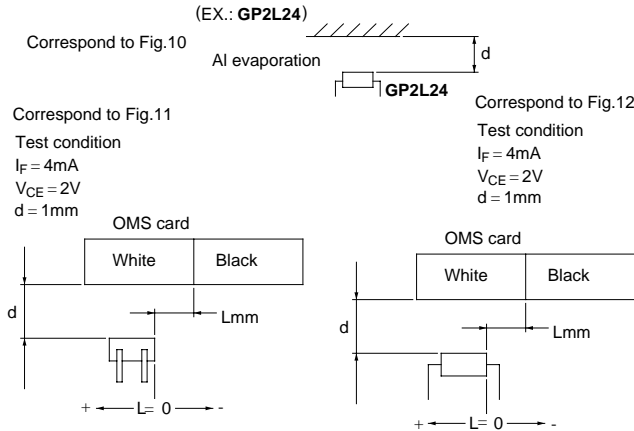

Fig.13 Frequency Response (GP2L09)

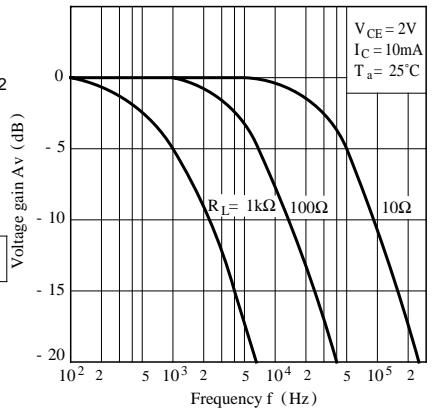

Fig.14 Frequency Response (GP2L24/ GP2L26)

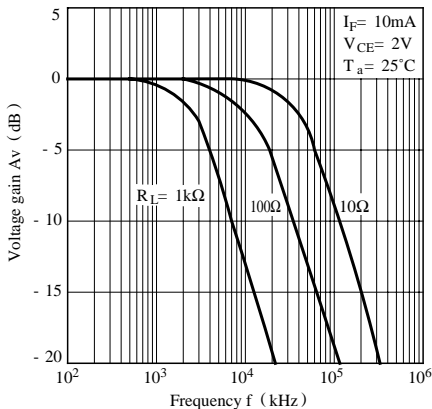
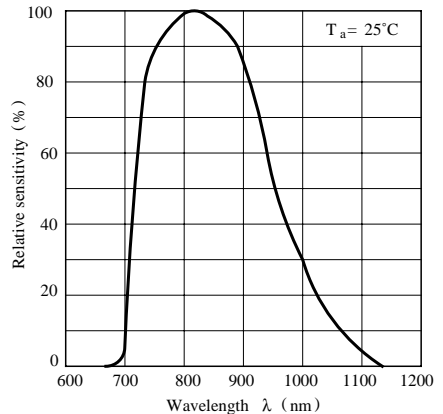

Fig.15 Spectral Sensitivity (Detecting Side)



■ Precautions for Use

- (1) In order to stabilize power supply line, connect a by-pass capacitor of more than 0.01 μ F between Vcc and GND near the device.
- (2) In this product, the PWB is fixed with a resin cover, and cleaning solvent may remain inside the case; therefore, dip cleaning or ultrasonic cleaning are prohibited.
- (3) Remove dust or stains, using an air blower or a soft cloth moistened in cleaning solvent. However, do not perform the above cleaning using a soft cloth with cleaning solvent in the marking portion.
In this case, use only the following type of cleaning solvent used for wiping off:
Ethyl alcohol, Methyl alcohol, Isopropyl alcohol, Freon TE, Freon TF, Diflon solvent S3-E
When the cleaning solvents except for specified materials are used, please consult us.
- (4) As for other general cautions, refer to the chapter “Precautions for Use”.