

GP2L22

Subminiature, High Sensitivity Photointerrupter

■ Features

1. ϕ 4mm compact resin mold type
2. High sensitivity (I_C : MIN. 0.5mA at $I_F = 4mA$)
3. Optimum detection distance: 0.6mm
4. Visible light cut-off type

■ Applications

1. Audio equipment, VCRs

■ Outline Dimensions

(Unit : mm)

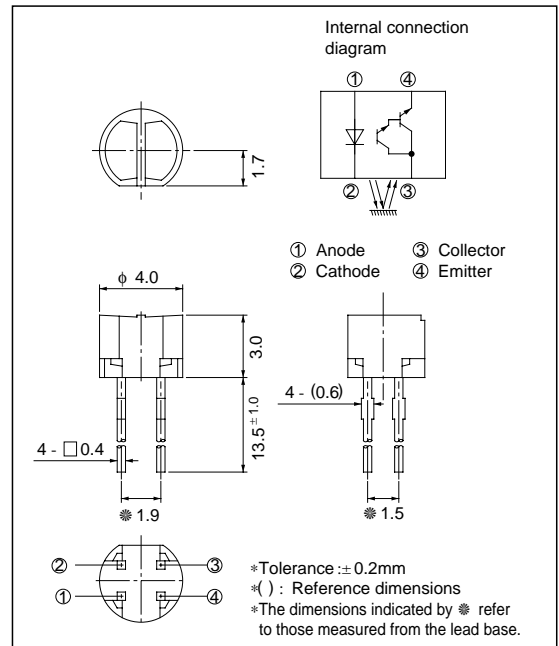

■ Absolute Maximum Ratings

(Ta = 25°C)

Parameter		Symbol	Rating	Unit
Input	Forward current	I_F	50	mA
	Reverse voltage	V_R	6	V
	Power dissipation	P	75	mW
Output	Collector-emitter voltage	V_{CEO}	35	V
	Emitter-collector voltage	V_{ECO}	6	V
	Collector current	I_C	50	mA
	Collector power dissipation	P_C	75	mW
Total power dissipation		P_{tot}	100	mW
Operating temperature		T_{opr}	- 25 to + 85	°C
Storage temperature		T_{sg}	- 40 to + 100	°C
*1 Soldering temperature		T_{sol}	260	°C

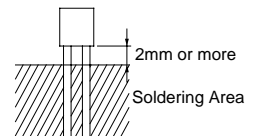

*1 For 3 seconds by manual soldering

Electro-optical Characteristics

($T_a = 25^\circ\text{C}$)

Parameter		Symbol	Conditions	MIN.	TYP.	MAX.	Unit	
Input	Forward voltage	V_F	$I_F = 20\text{mA}$	-	1.2	1.4	V	
	Reverse current	I_R	$V_R = 6\text{V}$	-	-	10	μA	
Output	Collector dark current	I_{CEO}	$V_{CE} = 10\text{V}$	-	-	10^{-6}	A	
Transfer characteristics	^{*2} Collector current		I_C	$V_{CE} = 5\text{V}, I_F = 4\text{mA}$	0.5	-	15	mA
	Response time	Rise time	t_r	$V_{CE} = 2\text{V}, I_C = 10\text{mA}$	-	80	400	μs
		Fall time	t_f	$R_L = 100\ \Omega, d = 1\text{mm}$	-	70	400	μs
	^{*3} Leak current		I_{LEAK}	$V_{CE} = 5\text{V}, I_F = 4\text{mA}$	-	-	5	μA

*2 The condition and arrangement of the reflective object are shown in the right drawing.

*3 Without reflective object

The ranking of collector current shall be classified into the following 5 ranks.

Rank	I_C (mA)
A	4.0 to 15.0
B	1.45 to 5.4
A or B	1.45 to 15.0
B or C	0.5 to 5.4
A, B or C	0.5 to 15.0

Test Condition and Arrangement for Collector Current

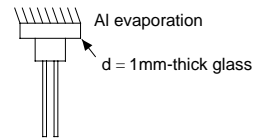

Fig. 1 Forward Current vs. Ambient Temperature

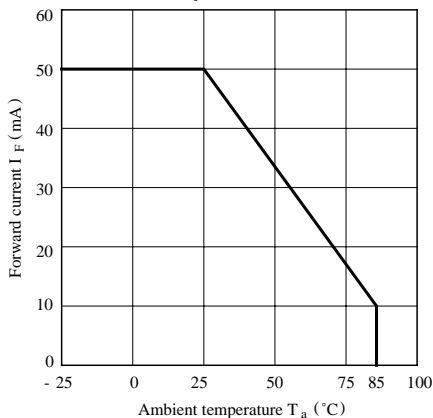

Fig. 2 Power Dissipation vs. Ambient Temperature

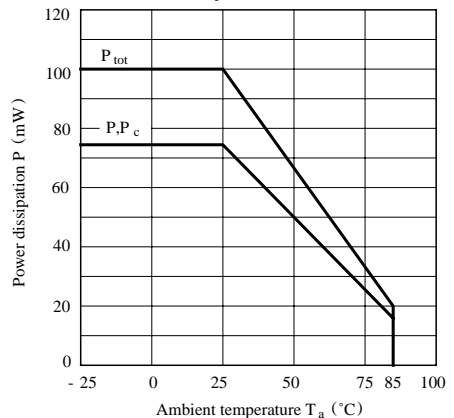

Fig. 3 Forward Current vs. Forward Voltage

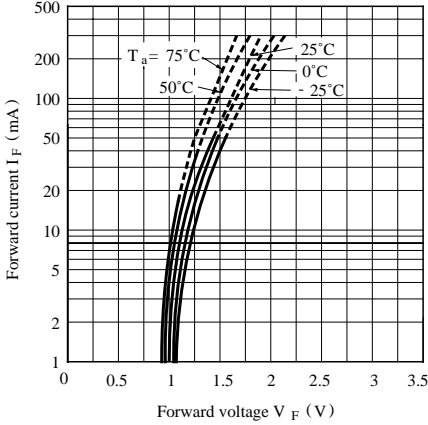

Fig. 4 Collector Current vs. Forward Current

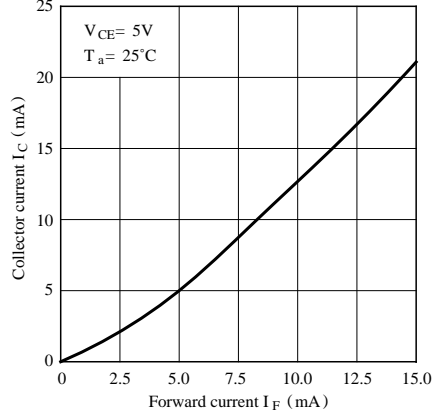

Fig. 5 Collector Current vs. Collector-emitter Voltage

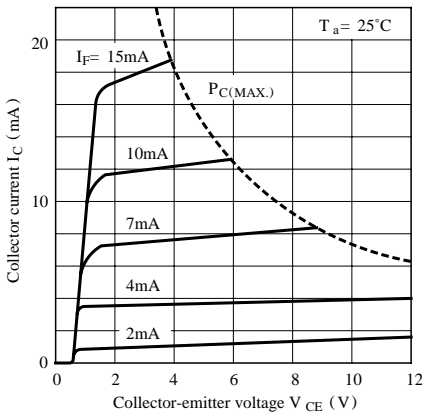

Fig. 6 Collector Current vs. Ambient Temperature

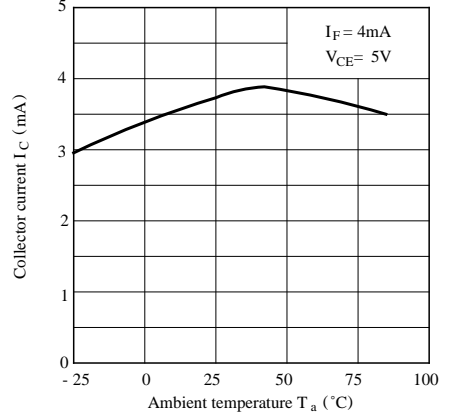

Fig. 7 Collector Dark Current vs. Ambient Temperature

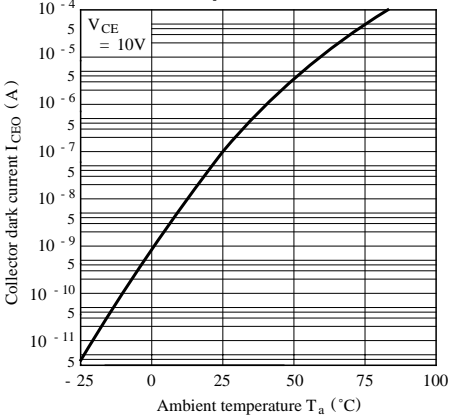
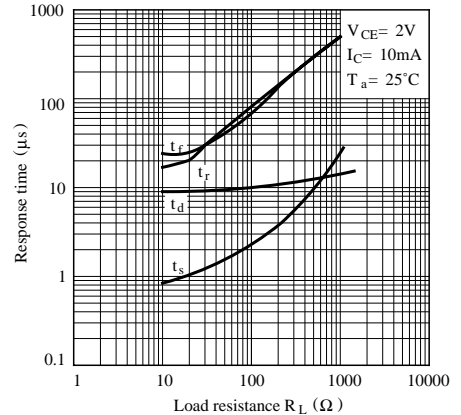

Fig. 8 Response Time vs. Load Resistance



Test Circuit for Response time

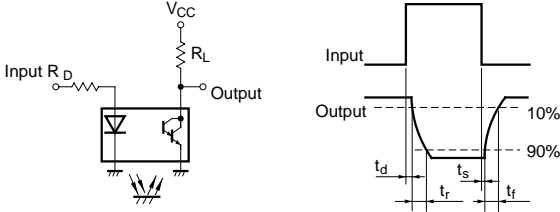

Fig.9 Relative Collector Current vs. Distance between Sensor and Test Card

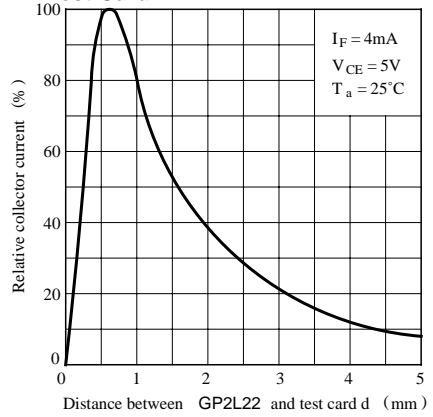
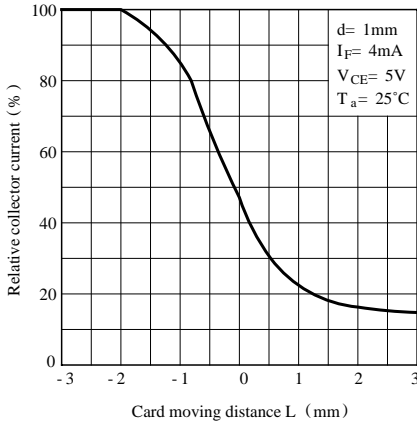

Fig.10 Relative Collector Current vs. Card Moving Distance



Test Condition for Distance & Detecting Position Characteristics

Correspond to Fig.9



Correspond to Fig.10

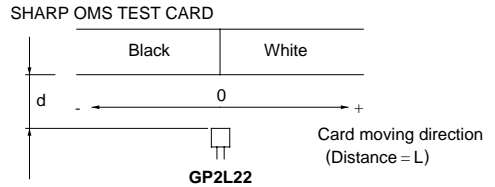

■ Precautions for Use

- (1) Perform soldering manually.
- (2) Please refrain from soldering under preheating and refrain from soldering by reflow.
- (3) As for other general cautions, refer to the chapter “Precautions for Use”.