

IS455

Linear Output Type OPIC Light Detector

■ Features

1. Linear output
2. Capable of output voltage level adjustment due to external resistor

■ Applications

1. Copiers

■ Outline Dimensions

(Unit : mm)

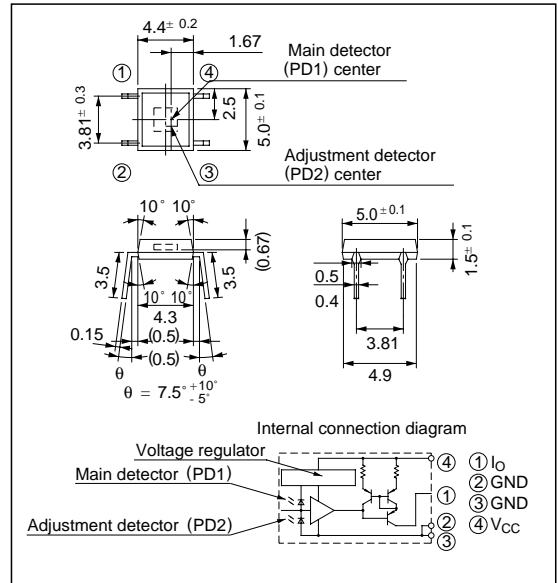

*** OPIC™ (Optical IC) is a trademark of the SHARP Corporation.
An OPIC consists of a light-detecting element and signal-processing circuit integrated onto a single chip.

■ Enlarged Figure of Light Detecting Portion

(Unit : μm)

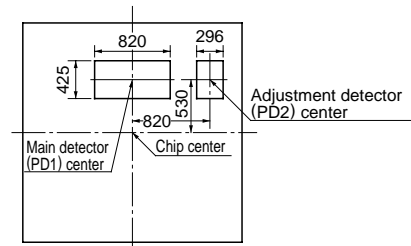

■ Absolute Maximum Ratings (Ta= 25°C)

Parameter	Symbol	Rating	Unit
Supply voltage	V _{CC}	-0.5 to +8	V
Output voltage	V _O	-0.5 to V _{CC}	V
Output current	I _O	- 10	mA
Power dissipation	P _O	150	mW
Operating temperature	T _{opr}	-25 to +85	°C
Storage temperature	T _{stg}	-40 to +85	°C
*1 Soldering temperature	T _{sol}	260	°C

*1 For 3 seconds at the position of 1mm from the bottom face of resin package.

■ Electro-optical Characteristics

($T_a = 25^\circ\text{C}$, $V_{CC} = 5\text{V}$)

Parameter	Symbol	Conditions	MIN.	TYP.	MAX.	Unit
Supply current	I_{CC}	$E_v = 0 \text{ lx}$	0.2	0.55	1.0	mA
Output current 1	I_{O1}	$E_v = 10 \text{ lx}^{*2}$	-6.5	-10	-13.5	μA
Output current 2	I_{O2}	$E_v = 1\,000 \text{ lx}^{*2}$	-0.65	-1	-1.35	mA
^{*3} Output current ratio	R_{IO}	-	92	100	108	-
Dark output current	I_{od}	$E_v = 0$	-	-10	-500	nA
Peak sensitivity wavelength	λ_P	-	-	700	-	nm

^{*2} E_v : Illuminance by CIE standard light source A (tungsten lamp)

^{*3} $R_{IO} = \frac{I_{O2}}{I_{O1}}$

■ Recommended Operating Conditions

Parameter	Symbol	MIN.	MAX.	Unit
Supply voltage	V_{CC}	4.5	5.5	V
^{*4} Illuminance	E_v	10	5\,000	lx
Output voltage	V_O	0	$V_{CC} - 1.5$	V
Operating temperature	T_{opr}	-10	70	$^\circ\text{C}$

^{*4} E_v : Illuminance by standard light source A (tungsten lamp)

Fig. 1 Power Dissipation vs. Ambient Temperature

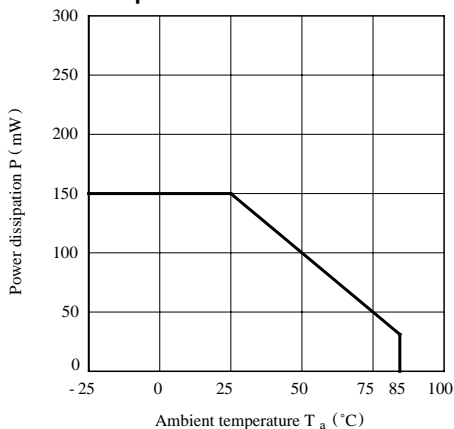

Fig. 2 Output Current vs. Illuminance

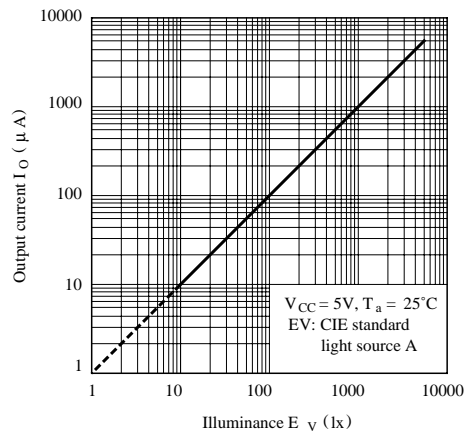

Fig. 3 Spectral Sensitivity

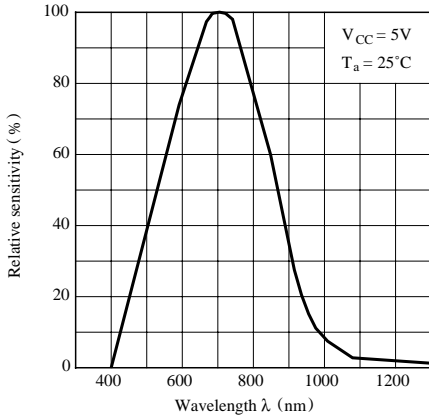

Fig. 4 Relative Output Current vs. Ambient Temperature

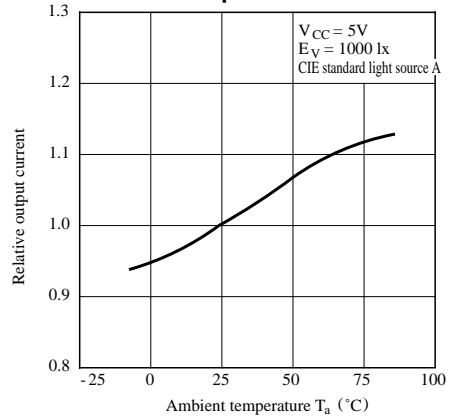

Fig. 5 Dark Output Current vs. Ambient Temperature

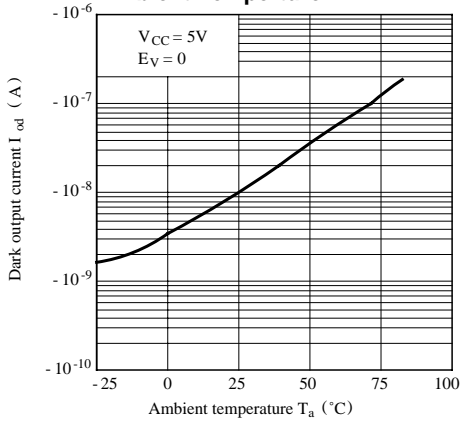

Fig. 6 Output Current vs. Supply Voltage

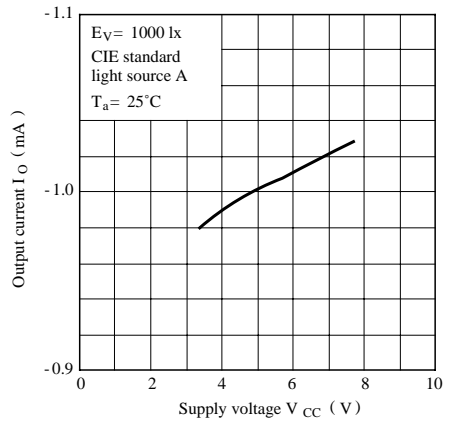
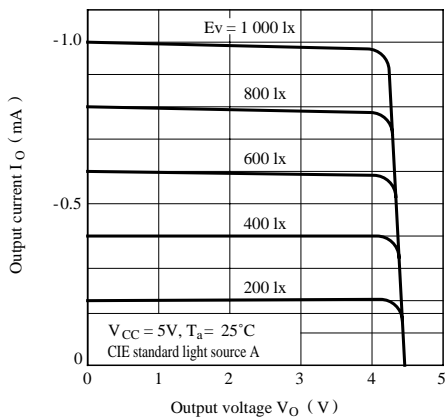

Fig. 7 Output Current vs. Output Voltage



Test Circuit for Output Current vs. Output Voltage

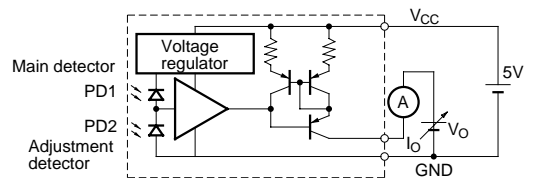

Fig. 8 Supply Current vs. Supply Voltage

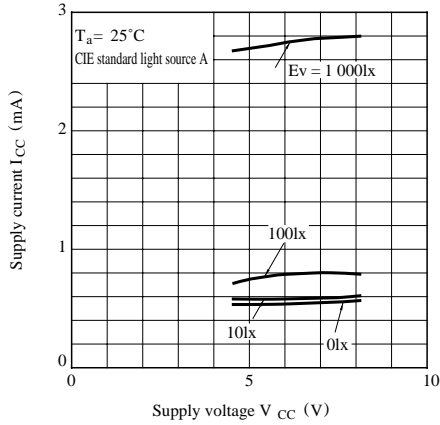

Fig. 9 Supply Current vs. Threshold Illuminance

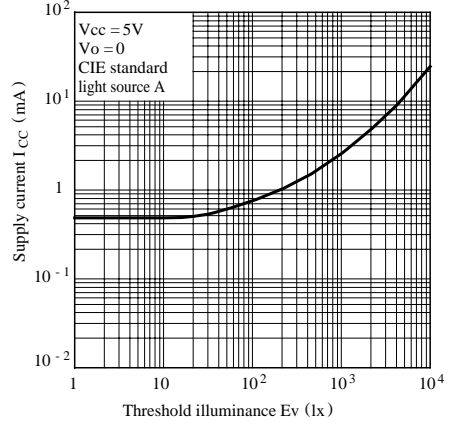
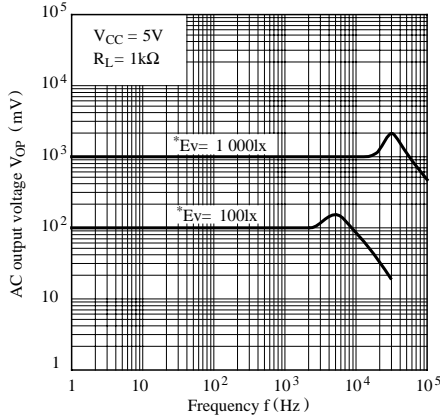

Fig.10 Frequency



Test Circuit For Frequency

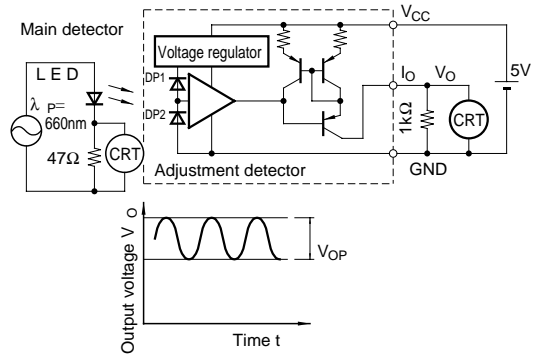

Fig.11 Supply Voltage Rejection Ratio vs. Ripple Frequency (1)

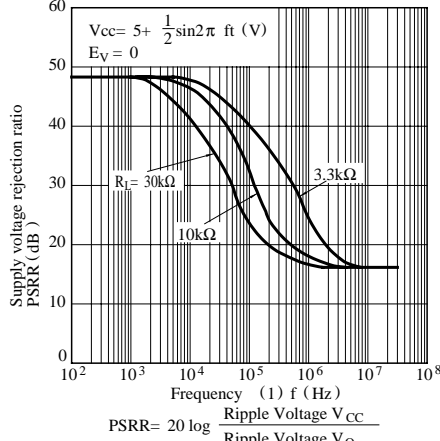

Fig.12 Supply Voltage Rejection Ratio vs. Ripple Frequency (2)

