

PREPARED BY: DATE

APPROVED BY: DATE

SHARP

LIQUID CRYSTAL DISPLAY GROUP
SHARP CORPORATION

SPECIFICATION

SPEC No. LD7620

FILE No.

ISSUE: Jun. 29. 1995

PAGE : 17 pages

APPLICABLE GROUP

Liquid Crystal Display
Group

DEVICE SPECIFICATION FOR

TFT-LCD module

MODEL No.

LQ9D161

CUSTOMER'S APPROVAL

DATE _____

BY _____

PRESENTED

BY

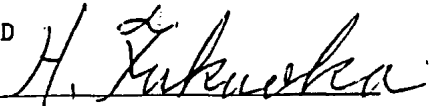

H. FUKUOKA

Department General Manager

Engineering Department 2

TFT LCD Development Center

LIQUID CRYSTAL DISPLAY GROUP

SHARP CORPORATION

1. Application

This specification applies to a color TFT-LCD module, LQ9D161.

2. Overview

This module is a color active matrix LCD module incorporating amorphous silicon TFTs (Thin Film Transistors). This module is composed of a low-reflection-type color TFT-LCD panel, driver ICs, control circuit, power supply circuit and a backlight unit. Graphics and texts can be displayed on a 640x3x480 dots panel with 4,096 colors by supplying 12 bit data signals(4bit/color), four timing signals, +3.3V DC supply voltage for TFT-LCD panel driving and supply voltage for backlight.

But, a DC/AC inverter for backlight-driving is NOT built in this module.

Optimum viewing direction is 6 o'clock.

[Features]

- ◎ Low driving voltage and low power consumption.
- ◎ Small footprint and thin shape.
- ◎ Light weight.
- ◎ Low surface reflection.

3. Mechanical Specifications

Parameter	Specifications	Unit
Display size	21 (8.4") Diagonal	cm
Active area	170.9(H)×129.6(V)	mm
Pixel format	640(H)×480(V) (1 pixel=R+G+B dots)	pixels
Pixel pitch	0.267(H)×0.270(V)	mm
Pixel arrangement	R.G.B vertical stripe	
Display mode	Normally white	
Unit outline dimensions *1	216.0(W)×152.4(H)×7.3(D)	mm
Mass	330±10	g
Surface treatment	Anti-glare, hard-coating(2H) and low-reflection(~5%)	
Haze value	25±5	%

*1 Note: excluding backlight cables and mounting tabs.

The outline dimensions is shown in Fig.1

4. Input Terminals

4-1. TFT-LCD panel driving

The module-side connector: DF9BA-31P-1V (Hirose Electric Co., Ltd.)

CN1

The user-side connector : DF9-31S-1V (), □ is blank. A or B.

Pin No.	Symbol	Function	Remark
1	R0	RED data signal (LSB)	
2	GND		
3	R1	RED data signal	
4	Vsync	Vertical synchronous signal	【Note1】
5	R2	RED data signal	
6	Hsync	Horizontal synchronous signal	【Note1】
7	R3	RED data signal (MSB)	
8	GND		
9	GND		
10	CK	Clock signal for sampling each data signal	
11	G0	GREEN data signal (LSB)	
12	GND		
13	G1	GREEN data signal	
14	TST	This should be electrically opened during operation	
15	GND		
16	TST	This should be electrically opened during operation	
17	G2	GREEN data signal	
18	TST	This should be electrically opened during operation	
19	G3	GREEN data signal (MSB)	
20	GND		
21	GND		
22	Vcc	+3.3V power supply	
23	B0	BLUE data signal (LSB)	
24	Vcc	+3.3V power supply	
25	B1	BLUE data signal	
26	TST	This should be electrically opened during operation	
27	GND		
28	ENAB	Signal to settle the horizontal display position	【Note2】
29	B2	BLUE data signal	
30	GND		
31	B3	BLUE data signal (MSB)	

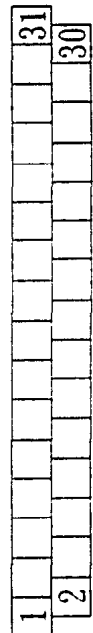

CN1 pin arrangement from module surface

※The shielding case is connected with GND in the module.

【Note1】 One of 480-, 400- and 350-line mode is selected depending on the polarity combination of the both synchronous signals.

mode	480-line	400-line	350-line
Hsync	negative	negative	positive
Vsync	negative	positive	negative

【Note2】 The horizontal display start timing is settled in accordance with a rising edge of ENAB signal. In case ENAB is fixed "Low", the horizontal display start timing is determined as described in 7-2. Do not keep ENAB "High" during operation.

4-2. Backlight driving

The module-side connector : BHR-03VS-1(JST)

CN2 The user-side connector : SM02(8.0)B-BHS(JST)

Pin no.	symbol	function
1	V _{HIGH}	Power supply for lamp (High voltage side)
3	V _{LOW}	Power supply for lamp (Low voltage side)

5. Absolute Maximum Ratings

Parameter	Symbol	Condition	Ratings	Unit	Remark
Input voltage	V _I	Ta=25℃	-0.3 ~ Vcc+0.3	V	【Note1】
Vcc supply voltage	Vcc	Ta=25℃	0 ~ +6	V	
Storage temperature	Tstg	-	-25 ~ +60	℃	【Note2】
Operating temperature (Ambient)	Topa	-	0 ~ +50	℃	

【Note1】 CK, R0~R3, G0~G3, B0~B3, Hsync, Vsync, ENAB

【Note2】 Humidity : 95%RH Max. at Ta≤40℃.

Maximum wet-bulb temperature at 39℃ or less at Ta>40℃.

No condensation.

6. Electrical Characteristics

6-1. TFT-LCD panel driving

Ta = 25℃

Parameter	Symbol	Min.	Typ.	Max.	Unit	Remark
Vcc	Supply voltage	+3.0	+3.3	+3.6	V	【Note1】
	Supply current	-	105	350	mA	【Note2】
Permissive input ripple voltage	V _{RP}	-	-	100	mVp-p	Vcc
Input voltage (Low)	V _{IL}	-	-	0.3Vcc	V	【Note3】
Input voltage (High)	V _{IH}	0.7Vcc	-	-	V	
Input current (low)	I _{OL}	-	-	1.0	μA	V _I =0V 【Note3】
		-	-	1.0	μA	V _I =Vcc 【Note4】
Input current (High)	I _{OH1}	-	-	60.0	μA	V _I =Vcc 【Note5】
		-	-	60.0	μA	∴ 【Note5】

【Note1】

On-off condition
for supply voltage

- $0 < t1 \leq 10\text{msec}$
- $0 < t2 \leq 10\text{msec}$
- $0 < t3 \leq 1\text{sec}$
- $t4 \geq 10\text{msec}$

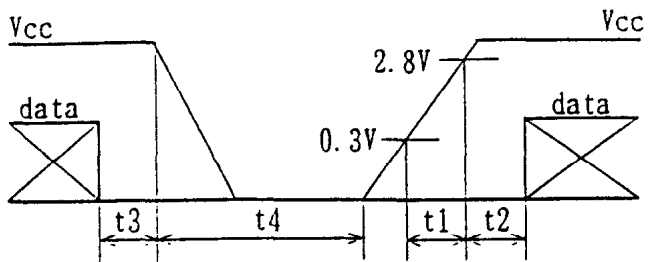

Vcc-dip conditions

- 1) $2.4\text{V} \leq V_{cc} < 2.8\text{V}$
 $t_d \leq 10\text{msec}$
- 2) $V_{cc} < 2.4\text{V}$

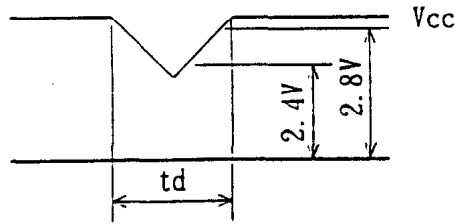

Vcc-dip conditions should also follow the Vcc-turn-on conditions

【Note2】 The typical value of I_{cc} is measured in the following condition.

Black pattern.

All of the timing parameters are typical value (480 line mode).

$V_{cc} = +3.3\text{V}$

【Note3】 CK, R0~R3, G0~G3, B0~B3, Hsync, Vsync, ENAB

【Note4】 CK, R0~R3, G0~G3, B0~B3, Hsync, Vsync

【Note5】 ENAB

6-2. Backlight driving

The backlight system is an edge-lighting type with single CCFT (Cold Cathode Fluorescent Tube). The characteristics of the lamp installed in the module are shown in the following table.

Parameter	Symbol	Min.	Typ.	Max.	Unit	Remark
Lamp voltage	V_L	-	400	-	Vrms	Just for reference
Lamp current	I_L	2.0	2.5 * ₁ 5.0 * ₂	5.5	mA _{rms}	【Note1】
Lamp power consumption	P_L	-	1.0 * ₁ 2.0 * ₂	-	W	【Note2】
Lamp frequency	F_L	20	35	60	kHz	【Note3】
Kick-off voltage	V_s	-	-	900	Vrms	$T_a = 25^\circ\text{C}$
		-	-	1000	Vrms	$T_a = 0^\circ\text{C}$
Lamp life time	L_L	10000	-	-	hour	【Note4】

*1: Luminance of white $Y_L = 70\text{cd/m}^2$ (Typ.)

*2: Luminance of white $Y_L = 140\text{cd/m}^2$ (Typ.)

【Note1】 Lamp current is measured with a current meter for high frequency as shown below.

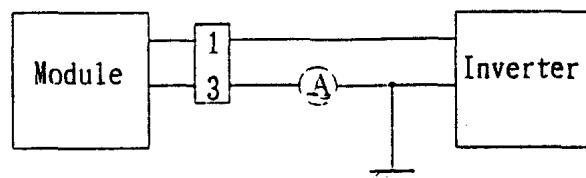

*3pin is $V_{L,low}$

【Note2】 Calculated value for reference. ($I_L \times V_L$)

【Note3】 Lamp frequency may produce interference with horizontal synchronous frequency, and this may cause beat on the display. Therefore lamp frequency shall be detached as much as possible from the horizontal synchronous frequency and from the harmonics of horizontal synchronous to avoid interference.

【Note4】 Lamp life time(L_L) is defined as the time when either ① or ② occurs in the continuous operation under the condition of $T_a=25^\circ\text{C}$ and $I_L=5.5\text{mA rms}$.

① Brightness becomes 50% of the original value.

② Kick-off voltage at $T_a=0^\circ\text{C}$ exceeds maximum value. 1000 Vrms.

Note) The performance of the backlight, for example life time or brightness, is much influenced by the characteristics of the DC-AC inverter for the lamp. When you design or order the inverter, please make sure that a poor lighting caused by the mismatch of the backlight and the inverter (miss-lighting, flicker, etc.) never occur. When you confirm it, the module should be operated in the same condition as it is installed in your instrument.

7. Timing Characteristics of input signals

The timing diagrams of the input signals are shown in Fig. 2-①~③.

7-1. Timing characteristics

Parameter		Symbol	Mode	Min.	Typ.	Max.	Unit	Remark
Clock	Frequency	1/Tc	all	-	25.18	28.33	MHz	
	High time	Tch	"	5	-	-	ns	
	Low time	Tcl	"	10	-	-	ns	
Data	Setup time	Tds	"	5	-	-	ns	
	Hold time	Tdh	"	10	-	-	ns	
Horizontal sync. signal	Period	TH	"	30.00	31.78	-	μs	
			"	770	800	900	clock	
	Pulse width	THp	"	2	96	200	clock	
Vertical sync. signal	Period	TV	480	515	525	560	line	
			400	445	449	480	line	
			350	447	449	510	line	
	Pulse width	TVp	all	2	-	34	line'	
Horizontal display period		THd	"	640	640	640	clock	
Hsync-Clock phase difference		THc	"	10	-	Tc-10	ns	
Hsync-Vsync phase difference		TVh	"	0	-	TH-THp	clock	

Note) In case of lower frequency, the deterioration of the display quality, flicker etc., may be occurred.

7-2. Horizontal display position

The horizontal display position is determined by ENAB signal and the input data corresponding to the rising edge of ENAB signal is displayed at the left end of the active area.

Parameter		Symbol	Mode	Min.	Typ.	Max.	Unit	Remark
ENAB signal	Setup time	Tes	all	5	-	Tc-10	ns	
	Pulse width	Tep	"	2	640	640	clock	
Hsync-ENAB signal phase difference		Tlle	"	44	-	164	clock	

Note) When ENAB is fixed "Low", the display starts from the data of C104(clock) as shown in Fig.2-①~③. Be careful that the module do not work when ENAB is fixed "High".

7-3. Vertical display position

The vertical display position is automatically centered in the active area at each mode of VGA, 480-, 400- and 350-line mode. Each mode is selected depending on the polarity of the synchronous signals described in 4-1 (Notel).

In each mode, the data of TVn is displayed at the top line of the active area. And the display position will be centered on the screen like the following figure when the period of vertical synchronous signal. TV. is typical value.

In 400- and 350-line mode, the data in the vertical data invalid period is also displayed. So, inputting all data "0" is recommended during vertical data invalid period.

ENAB signal has no relation to the vertical display position.

mode	V-data start(TVs)	V-data period(TVd)	V-display start(TVn)	Unit	Remark
480	34	480	34	line	
400	34	400	443-TV	line	
350	61	350	445-TV	line	

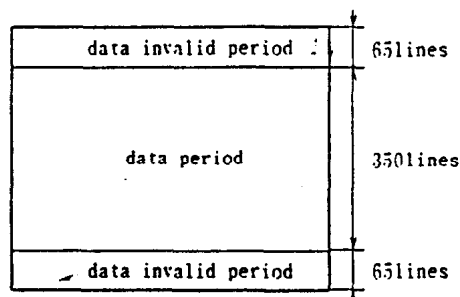
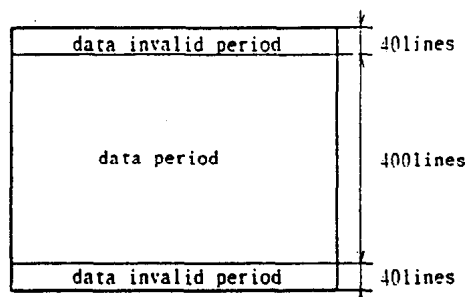

7-4. Input Data Signals and Display Position on the screen

Display position of input data (480-line mode)
(H·V)

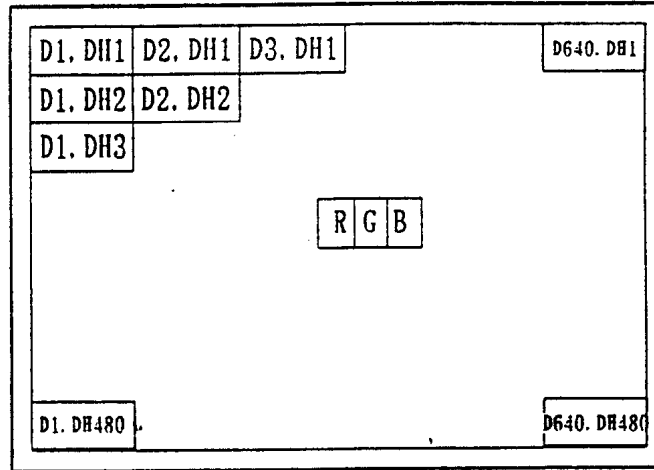

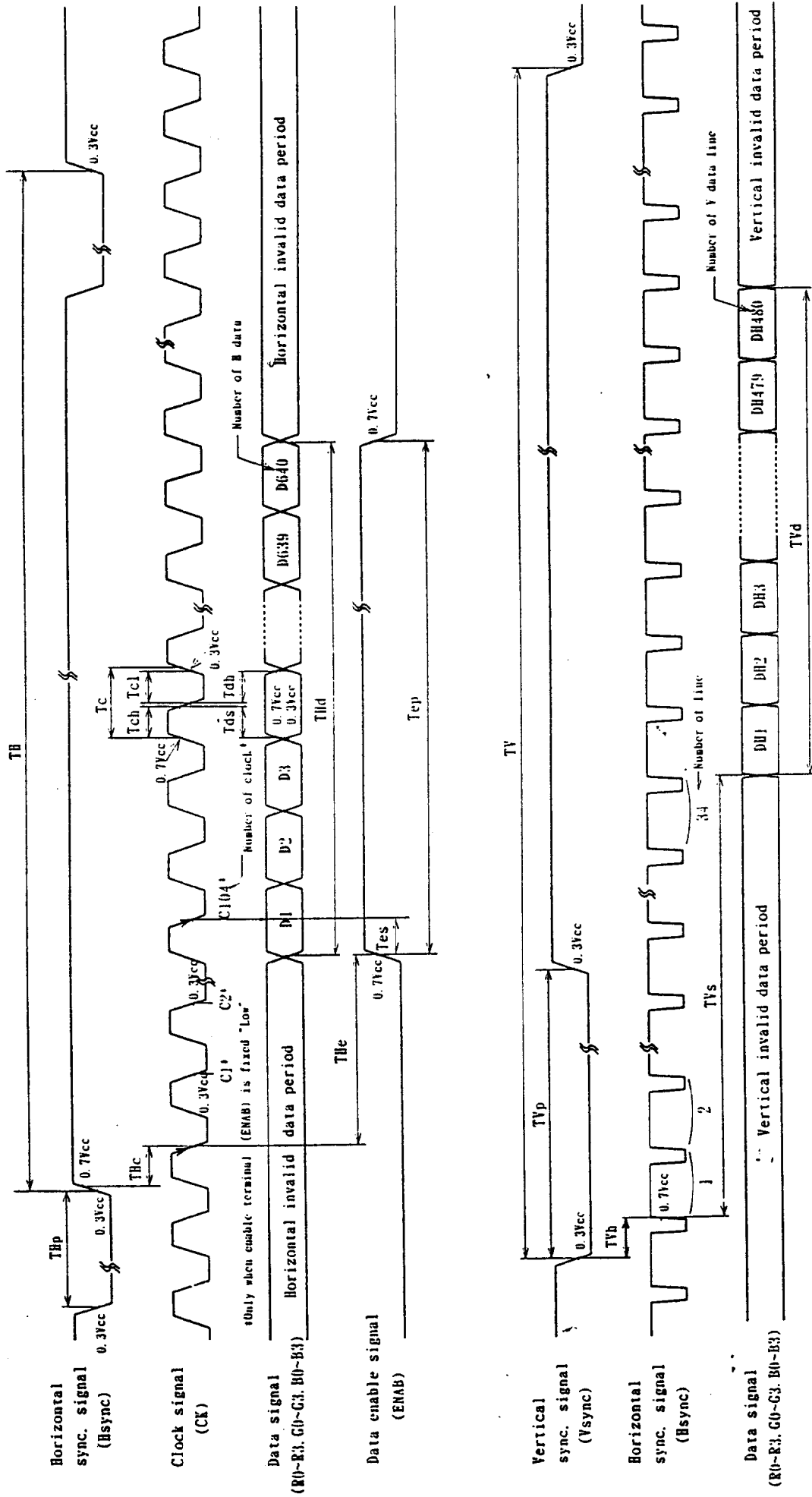

Fig. 2-① Input signal waveforms (480-line mode)

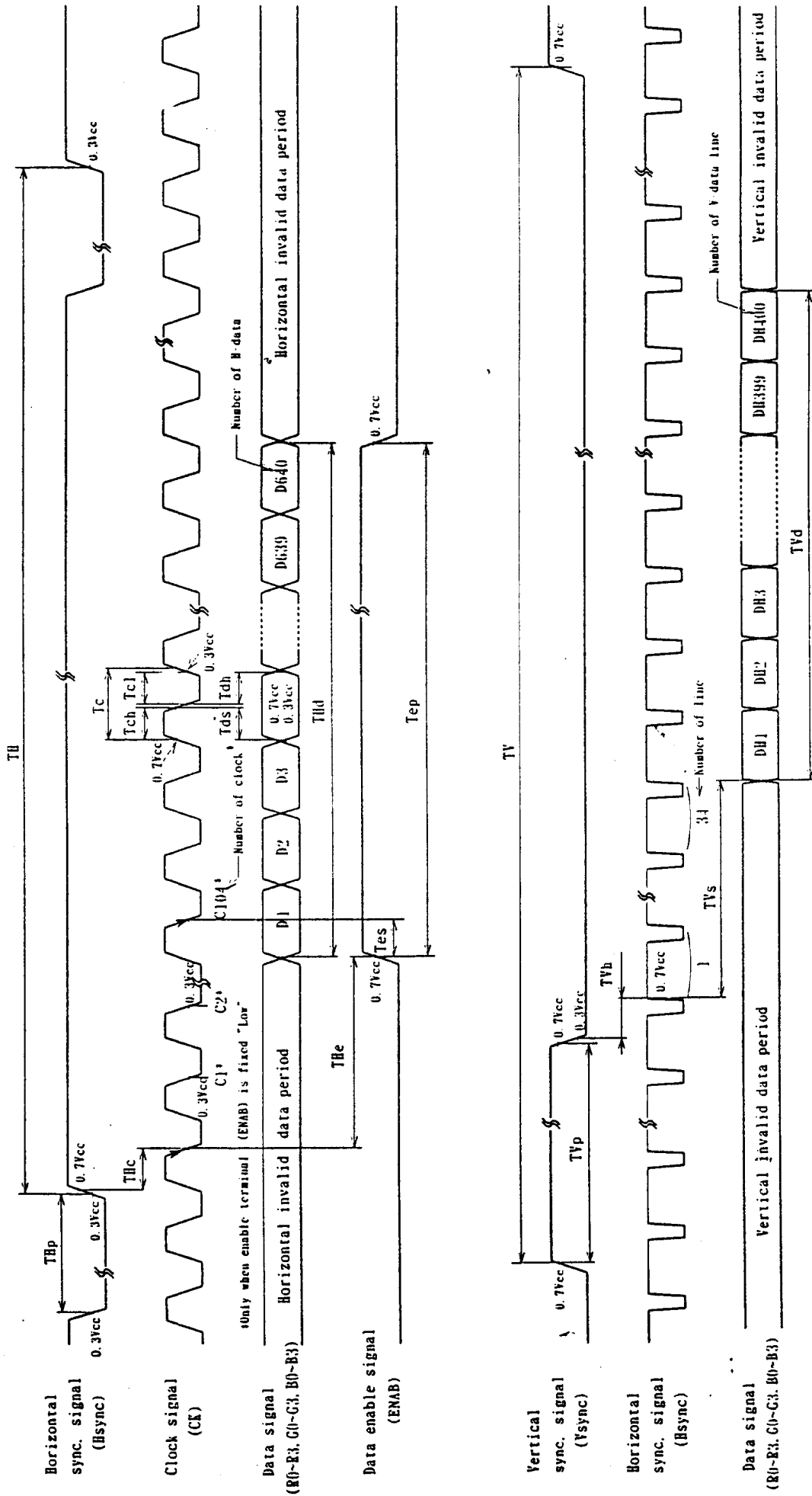

Fig. 2-2 Input signal waveforms (400-line mode)

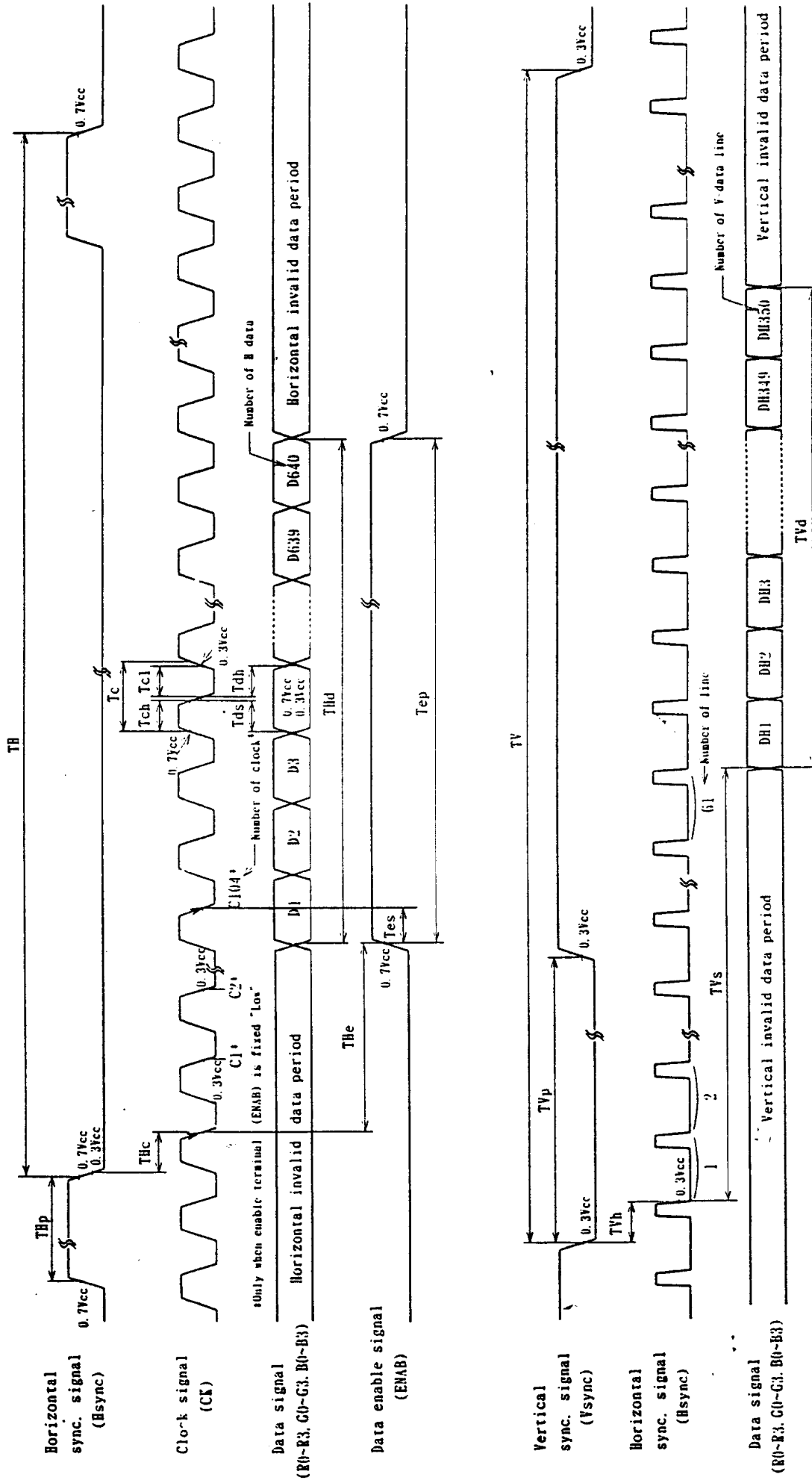

Fig. 2-3 Input signal waveforms (350-line mode)

8. Input Signals. Basic Display Colors and Gray Scale of Each Color

Color & Gray		Data signal													
		scale(GS)	GS	R0	R1	R2	R3	G0	G1	G2	G3	B0	B1	B2	B3
Basic color	Black	-	0	0	0	0	0	0	0	0	0	0	0	0	0
	Blue	-	0	0	0	0	0	0	0	0	1	1	1	1	
	Green	-	0	0	0	0	1	1	1	1	0	0	0	0	
	Light blue	-	0	0	0	0	1	1	1	1	1	1	1	1	
	Red	-	1	1	1	1	0	0	0	0	0	0	0	0	
	Purple	-	1	1	1	1	0	0	0	0	1	1	1	1	
	Yellow	-	1	1	1	1	1	1	1	1	0	0	0	0	
	White	-	1	1	1	1	1	1	1	1	1	1	1	1	
Gray Scale of Red	Black	GS0	0	0	0	0	0	0	0	0	0	0	0	0	0
	↑	GS1	1	0	0	0	0	0	0	0	0	0	0	0	0
	Darker	GS2	0	1	0	0	0	0	0	0	0	0	0	0	0
	↑	↓			↓										
	↓	↑			↑										
	Brighter	GS13	1	0	1	1	0	0	0	0	0	0	0	0	0
	↓	GS14	0	1	1	1	0	0	0	0	0	0	0	0	0
Red	GS15	1	1	1	1	0	0	0	0	0	0	0	0	0	
Gray Scale of Green	Black	GS0	0	0	0	0	0	0	0	0	0	0	0	0	0
	↑	GS1	0	0	0	0	1	0	0	0	0	0	0	0	0
	Darker	GS2	0	0	0	0	0	1	0	0	0	0	0	0	0
	↑	↓			↓										
	↓	↑			↑										
	Brighter	GS13	0	0	0	0	1	0	1	1	0	0	0	0	0
	↓	GS14	0	0	0	0	0	1	1	1	0	0	0	0	0
Green	GS15	0	0	0	0	1	1	1	1	0	0	0	0	0	
Gray Scale of Blue	Black	GS0	0	0	0	0	0	0	0	0	0	0	0	0	0
	↑	GS1	0	0	0	0	0	0	0	0	1	0	0	0	0
	Darker	GS2	0	0	0	0	0	0	0	0	0	1	0	0	0
	↑	↓			↓										
	↓	↑			↑										
	Brighter	GS13	0	0	0	0	0	0	0	0	1	0	1	1	1
	↓	GS14	0	0	0	0	0	0	0	0	0	1	1	1	1
Blue	GS15	0	0	0	0	0	0	0	0	1	1	1	1	1	

0: Low level voltage
1: High level voltage

Each basic color can be displayed in 16 gray scales from 4 bit data signals. According to the combination of total 12 bit data signals, the 4,096-colors display can be achieved on the screen.

9. Optical Characteristics

Ta=25°C, Vcc=+3.3V

Parameter		Symbol	Condition	Min.	Typ.	Max.	Unit	Remark
Viewing angle range	Horizontal	θ 21.22	CR > 10	35	-	-	Deg.	【Note1.4】
	Vertical	θ 11		10	-	-	Deg.	
		θ 12		30	-	-	Deg.	
Contrast ratio		CR	Optimum viewing angle	150	-	-		【Note2.4】
Response time	Rise	τ_r	$\theta = 0^\circ$	-	20	-	ms	【Note3.4】
	Decay	τ_d		-	40	-	ms	
Chromaticity of white		x		-	0.313	-		【Note4】
		y		-	0.329	-		
Luminance of white		Y_L	$\theta = 0^\circ$, IL=2.5mA	50	70	-	cd/m ²	【Note4】
			$\theta = 0^\circ$, IL=5.0mA	110	140	-	cd/m ²	
White Uniformity		δ_w	$\theta = 0^\circ$	-	-	i.45		【Note5】

Note) The measurement shall be executed 30 minutes after lighting at rating.

The optical characteristics shall be measured in a dark room or equivalent state with the method shown in Fig.3.

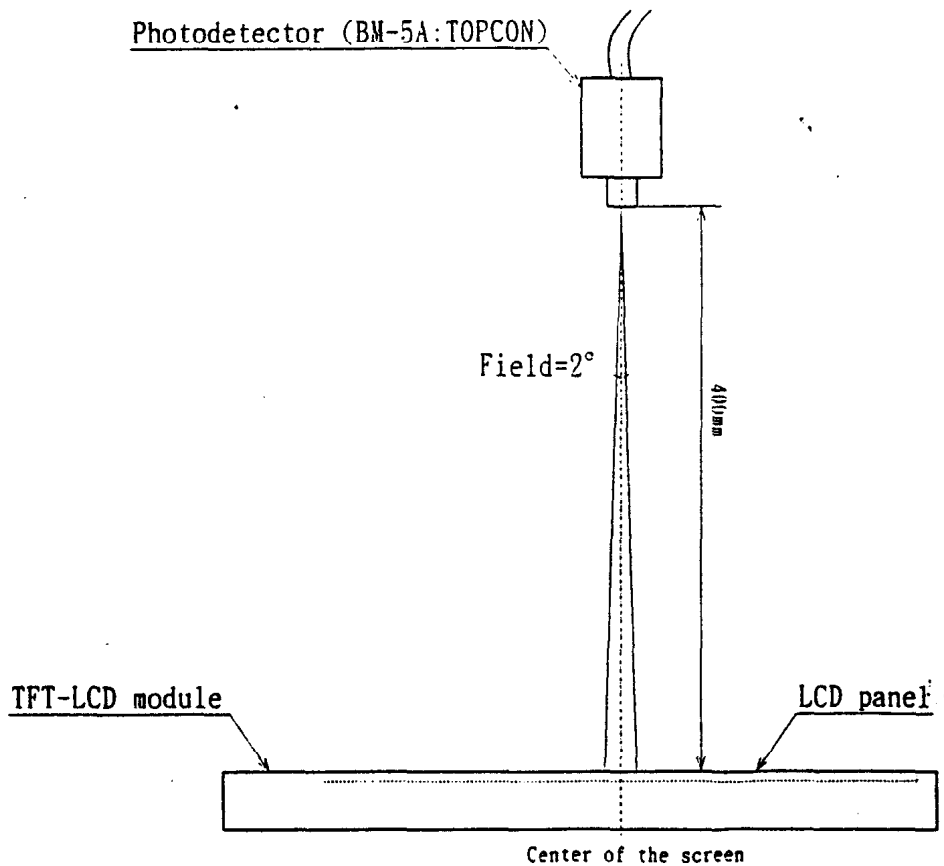
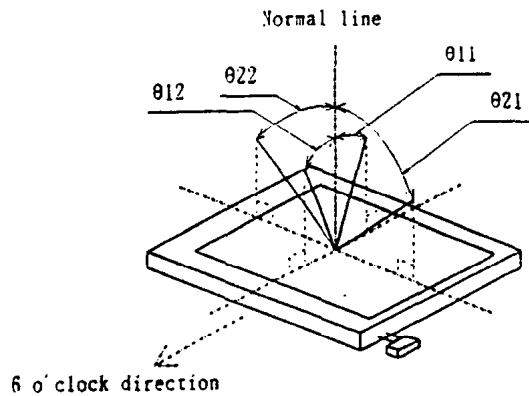

Fig.3 Optical characteristics measurement method

【Note1】 Definitions of viewing angle range:



【Note2】 Definition of contrast ratio:

The contrast ratio is defined as the following.

$$\text{Contrast Ratio (CR)} = \frac{\text{Luminance (brightness) of "white"}}{\text{Luminance (brightness) of "black"}}$$

【Note3】 Definitions of response time:

The response time is defined as the following figure and shall be measured by switching the input signal for "black" and "white".

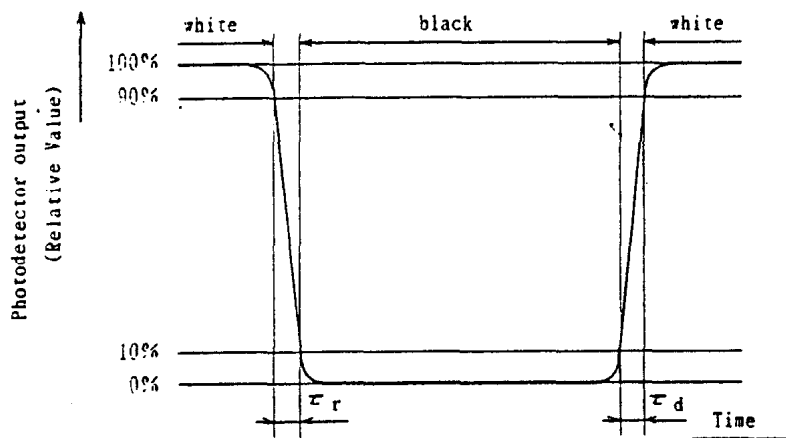

【Note4】 This shall be measured at center of the screen.

【Note5】 Definition of white uniformity:

White uniformity is defined as the following by five-point(A-E) measurements.

$$\delta w = \frac{\text{Maximum Luminance of five-point data}}{\text{Minimum Luminance of five-point data}}$$

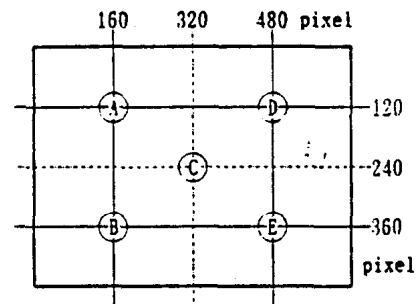

10. Display Quality

The display quality of the color TFT-LCD module shall be in compliance with the Incoming Inspection Standard.

11. Handling Precautions

- a) Laminated film is attached to the module surface to prevent it from being scratched. Peel the film off slowly, just before the use, with strict attention to electrostatic changes. Ionized air shall be blown over during the action. Blow off 'dust' on the polarizer by using an ionized nitrogen gun, etc.
- b) Be sure to turn off the power supply and signal when inserting or disconnecting the cable.
- c) Since LCD panel is made of glass, it may break or crack if it's dropped or bumped. Handle with care.
- d) The thin liquid crystal layer is packed in the LCD panel. This layer may be disturbed by the external force when the panel surface is pushed strongly and this disturbance may cause the transient display non-uniformity. So do not push the panel surface so strongly.
- e) Be sure to design the cabinet so that the module can be installed without any extra stress such as warp or twist.
- f) Since the front polarizer is easily damaged, pay attention not to scratch it.
- g) Wipe off water drop immediately. Long contact with water may cause discoloration or spots.
- h) When the panel surface is soiled, wipe it with absorbent cotton or other soft cloth.
- i) Since CMOS LSIs are used in this module, take care of static electricity and ensure the human earth when handling.
- j) Observe all other precautionary requirements in handling components.

12. Packing form

- a) Piling number of cartons : MAX. 7
 - b) Package quantity in one carton : MAX. 10
 - c) Carton size : 374(W)x254(H)x314(D)mm
 - d) Total weight of 1 carton filled with full modules : 4900 g
- Packing form is shown in Fig. 4.

13. Reliability test items

No.	Test item	Conditions
1	High temperature storage test	Ta=60℃ 240h
2	Low temperature storage test	Ta=-25℃ 240h
3	High temperature & high humidity operation test	Ta=40℃:95%RH 240h (No condensation)
4	High temperature operation test	Ta=50℃ 240h (The panel temp. must be less than 60℃)
5	Low temperature operation test	Ta=0℃ 240h
6	Vibration test (non-operating)	Frequency:10-57Hz/Vibration width (one side):0.075mm :58-500Hz/Gravity:9.8m/s ² Sweep time : 11 minutes Test period : 3 hours (1 hour for each direction of X, Y, Z)
7	Shock test (non-operating)	Max. gravity : 490m/s ² Pulse width : 11ms. half sine wave Direction : ±X, ±Y, ±Z once for each direction.

【Evaluation Criteria】

There shall be no change which may affect the practical use of this display under the Display Quality Test conditions.

14. Others

1) Lot No. Label:

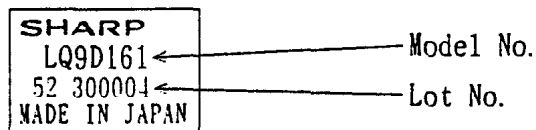

- 2) Adjusting volume have been set optimally before shipment, so do not change any adjusted value. If adjusted value is changed, the data mentioned in this technical literature may not be satisfied.
- 3) Disassembling the module can cause permanent damage and should be strictly avoided.
- 4) Please be careful since image retention may occur when a fixed pattern is displayed for a long time.
- 5) If any problem occur in relation to the description of this specification, it shall be resolved through discussion with spirit of cooperation.

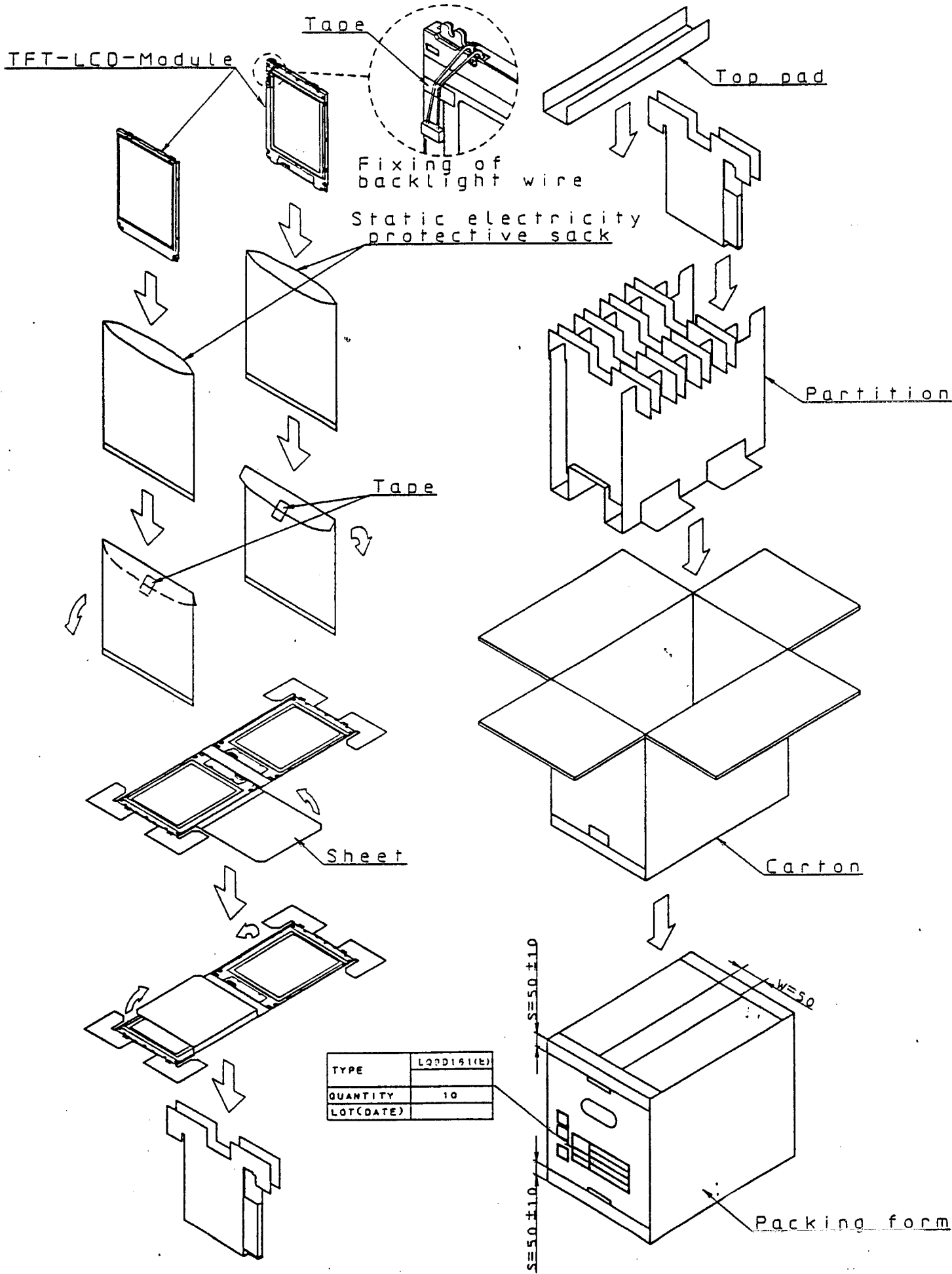
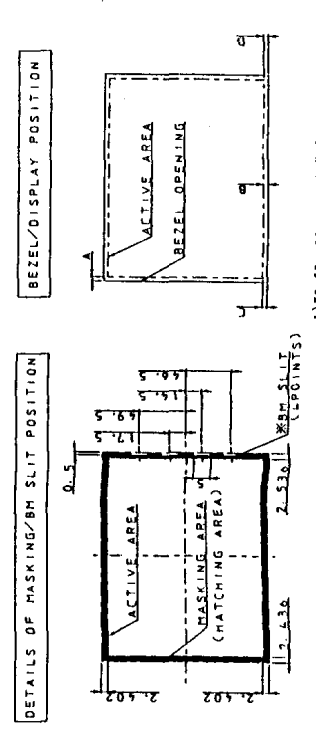
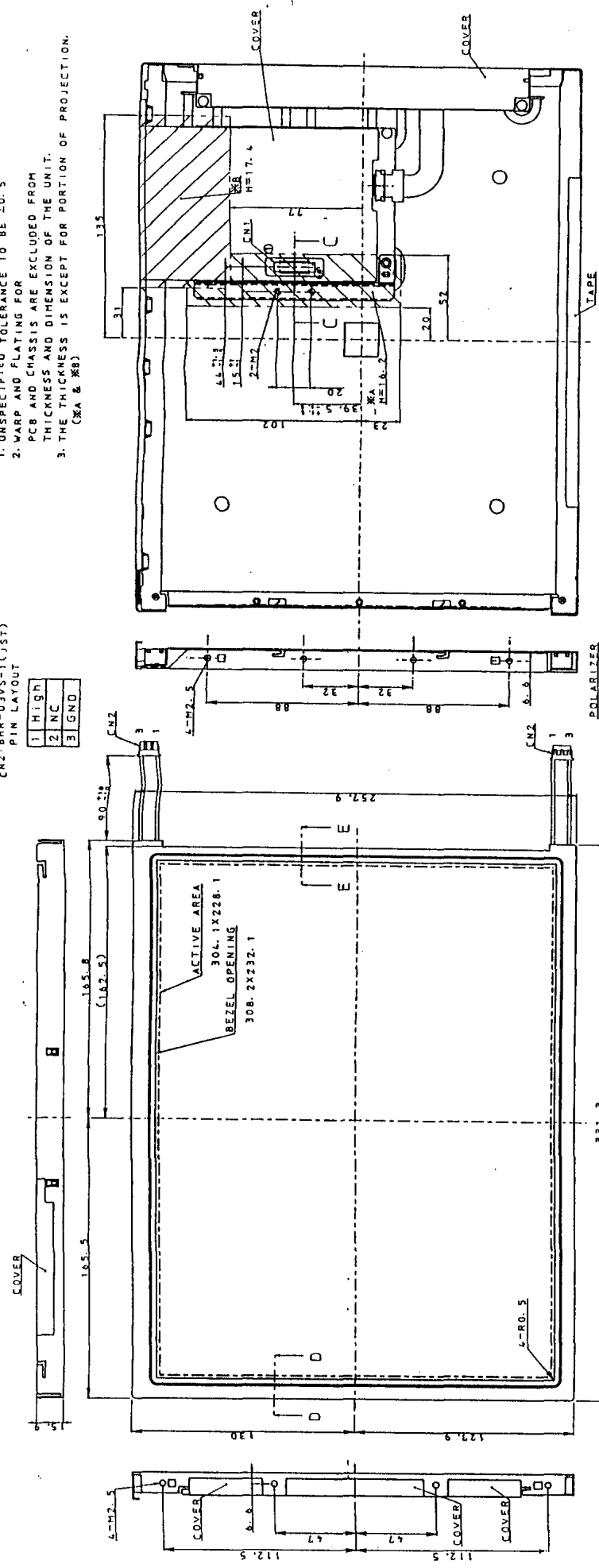

Fig. 4 Packing form

CCFT CONNECTOR
CN2: BHR-03VS-1 (JUST)
PIN LAYOUT

1	HIGH
2	NC
3	GND

- NOTES
1. UNSPECIFIED TOLERANCE TO BE ±0.5
 2. WARP AND FLATTING FOR PCB AND CHASSIS ARE EXCLUDED FROM THICKNESS AND DIMENSION OF THE UNIT.
 3. THE THICKNESS IS EXCEPT FOR PORTION OF PROJECTION. (X&A & B)



NOTE: THERE IS BM SLIT AT THE ABOVE MENTIONED POSITION AT THE RIGHT SIDE OF MODULE.

1) TOLERANCE ±0.1 (DIRECTION A: 250.8)
2) TOLERANCE ±0.1 (DIRECTION B: 250.8)
3) OBliquITY OF DISPLAY AREA IC-BI-Co. 8

BM SLIT: THE POSITION LOOKED DIFFERENT COLOR (LIKE BROWN) AT THE MASKING PORTION. THERE IS NO LIGHT LEAKAGE AT THE SLIT. (BM IS AN ABBREVIATION OF BLACK MASK).

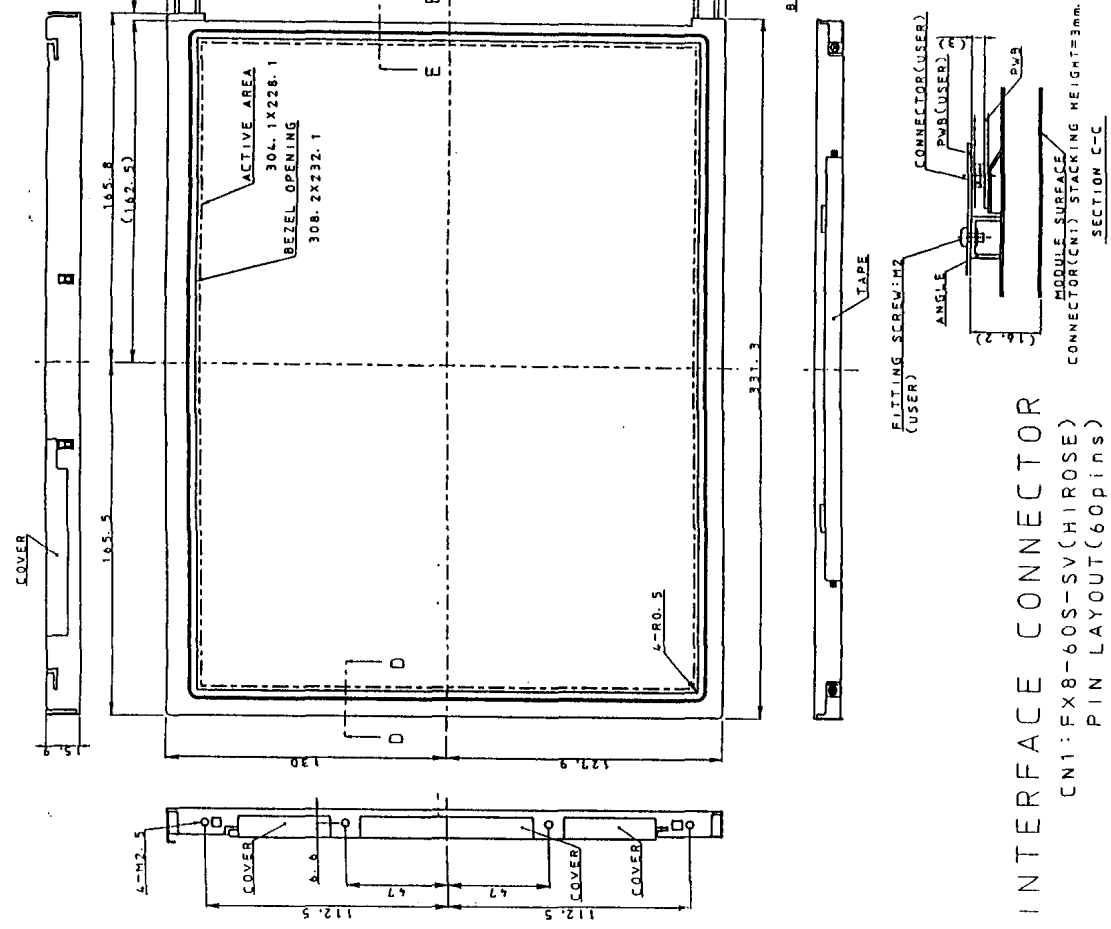
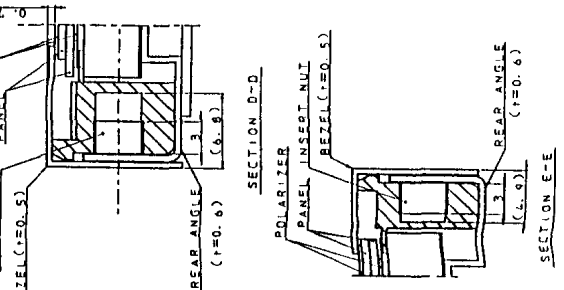

INTERFACE CONNECTOR
CN1: FX8-60S-SV (HIROSE)
PIN LAYOUT (60 pins)

SECTION C-C

PIN	1	2	3	4	5	6	7	8	9	10	11	12	13	14	15
GND	R0	R1	R2	R3	R4	R5	R6	R7	R8	R9	G0	G1	G2	G3	G4
16	17	18	19	20	21	22	23	24	25	26	27	28	29	30	31
B0	B1	B2	B3	B4	B5	GND	RA0	RA1	RA2	RA3	RA4	RA5	GND	GA0	GA1
32	33	34	35	36	37	38	39	40	41	42	43	44	45	46	47
GA2	GA3	GA4	GA5	GND	BA0	BA1	BA2	BA3	BA4	BA5	GND	GND	VS	MS	
48	49	50	51	52	53	54	55	56	57	58	59	60	*	*	*
DE	GND	GND	CLK-B	CLK-A	GND	GND	GND	MODE	VCC	VCC	VCC	VCC	*	*	*

FIG. 1. OUTLINE DIMENSIONS

LW1020U-11

LQ9D161

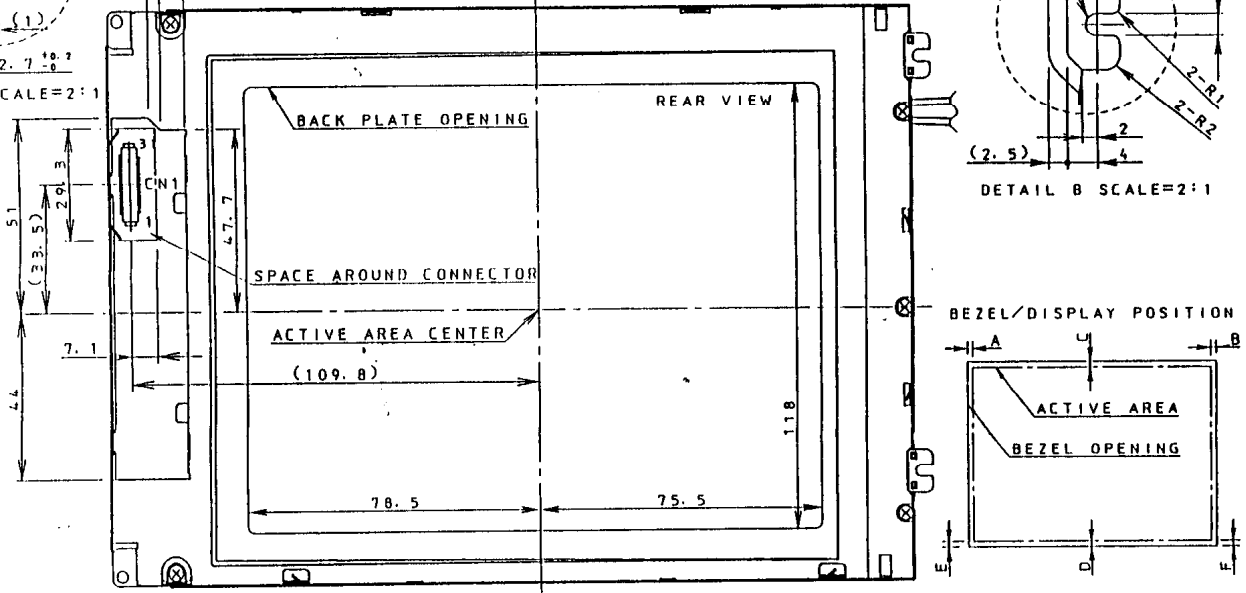
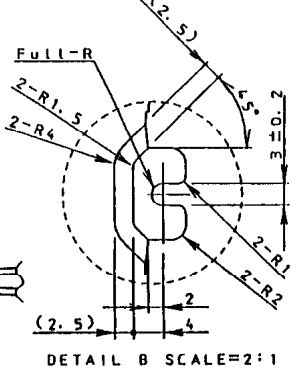
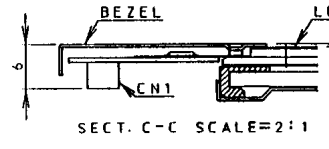
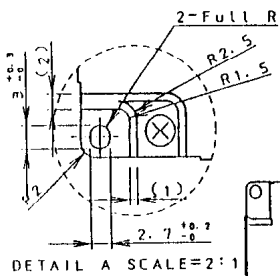
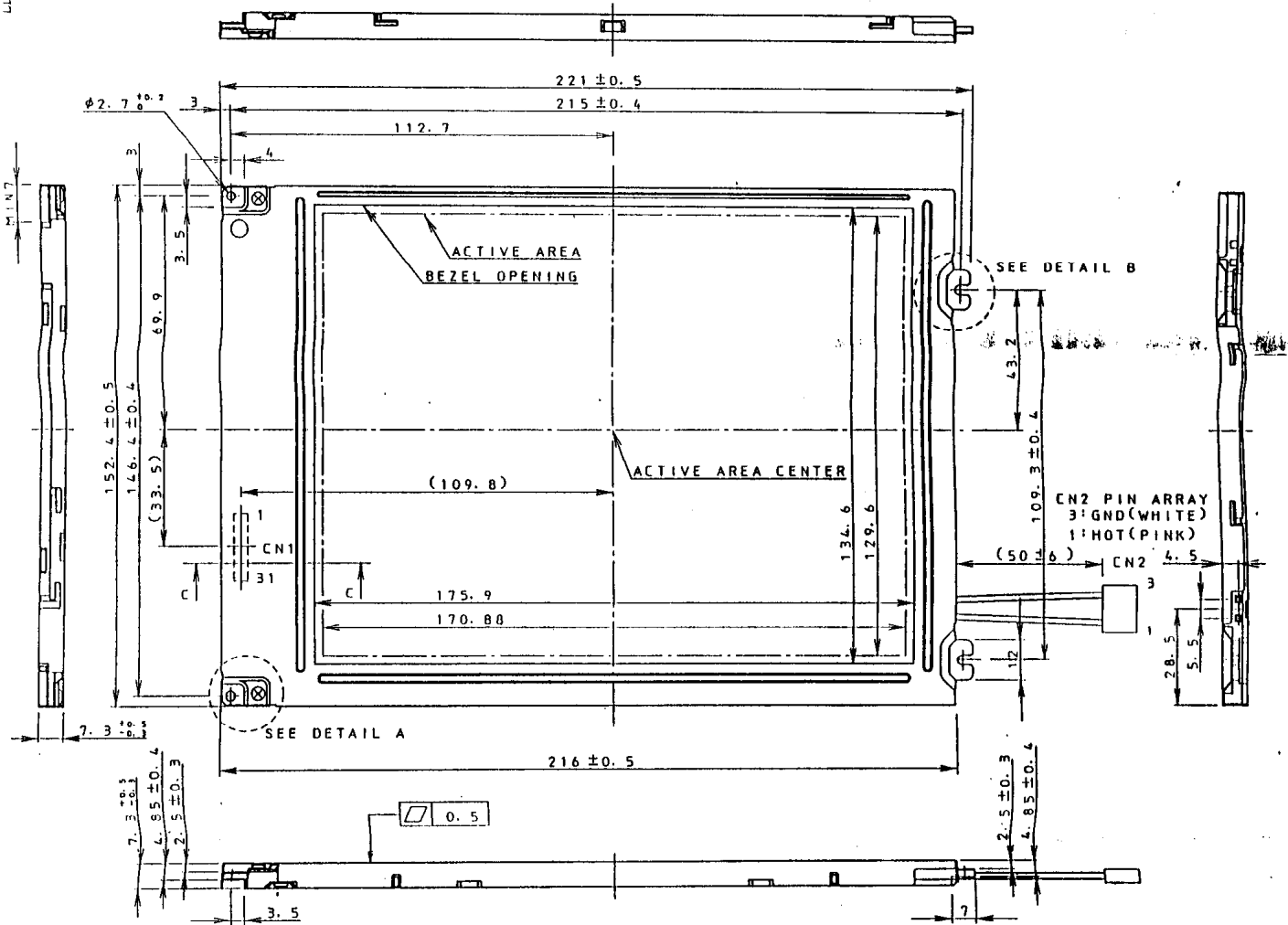

NOTES

Unspecified tolerance shall be ±0.5

CN1: DF9-31P-1V (HIROSE)

CN2: BHP-03VS-1 (JST)

- 1) TOLERANCE X-DIRECTION A: 2.51 ± 0.8
- 2) TOLERANCE X-DIRECTION B: 2.51 ± 0.8
- 3) TOLERANCE Y-DIRECTION C: 2.5 ± 0.8
- 4) TOLERANCE Y-DIRECTION D: 2.5 ± 0.8
- 5) OBLIQUITY OF DISPLAY AREA |E-F| < 0.8