

PT491/PT491F PT493/PT493F

■ Features

1. Epoxy resin package
2. Compact
3. Intermediate acceptance ($\Delta\theta$: TYP. $\pm 40^\circ$)
4. Long lead pin type : **PT493/PT493F**
5. Visible light cut-off type : **PT491F/PT493F**

■ Applications

1. VCRs
2. Optoelectronic switches

Intermediate Acceptance High Sensitivity Phototransistor

■ Outline Dimensions

(Unit : mm)

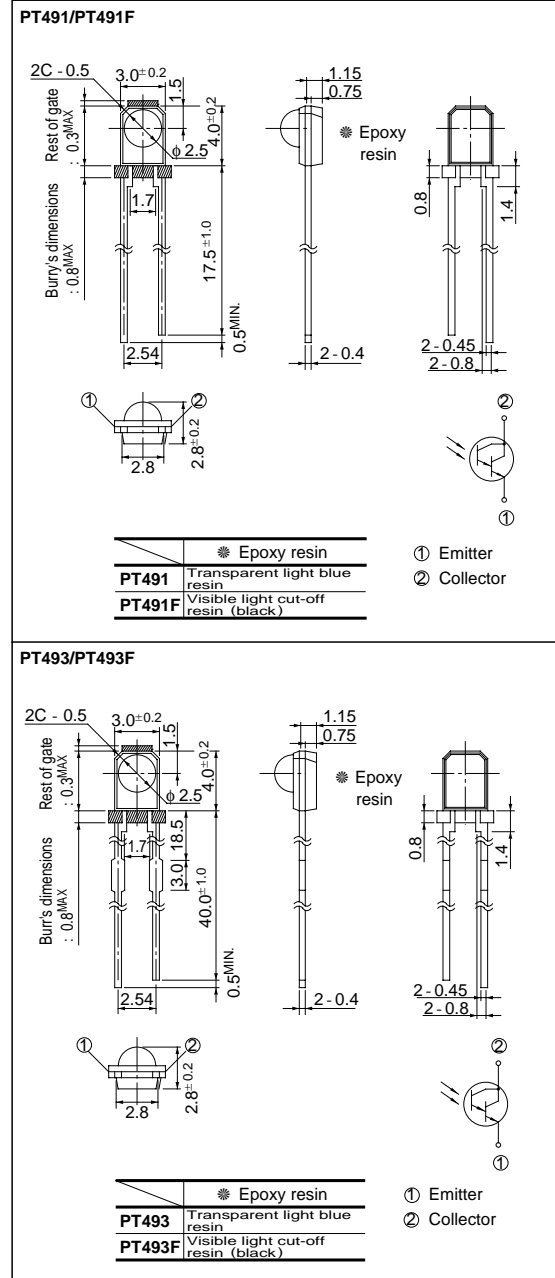

■ Absolute Maximum Ratings (Ta = 25°C)

Parameter	Symbol	Rating	Unit
Collector-emitter voltage	V_{CEO}	35	V
Emitter-collector voltage	V_{ECO}	6	V
Collector current	I_C	50	mA
Collector power dissipation	P_C	75	mW
Operating temperature	T_{opr}	-25 to +85	°C
Storage temperature	T_{stg}	-40 to +85	°C
*1 Soldering temperature	T_{sol}	260	°C

*1 For 3 seconds at the position of 1.4mm from the surface of resin edge

Electro-optical Characteristics

($T_a = 25^\circ\text{C}$)

Parameter	Symbol	Conditions	MIN.	TYP.	MAX.	Unit
*2Collector current	I_C	$V_{CE} = 2V$ $E_V = 21x$	0.3	0.6	1.3	mA
			0.2	0.4	0.8	mA
Collector dark current	I_{CEO}	$V_{CE} = 10V, E_e = 0$	-	-	10^{-6}	A
*2Collector-emitter saturation voltage	$V_{CE(sat)}$	$I_C = 0.8mA,$ $E_e = 1mW/cm^2$	-	-	1.0	V
Peak sensitivity wavelength	λ_p	-	-	800	-	nm
			-	860	-	nm
Response time	Rise time	$V_{CE} = 2V, I_C = 5mA$ $R_L = 100\Omega$	-	80	400	μs
	Fall time		-	70	350	
Half intensity angle	$\Delta\theta$	-	-	± 40	-	$^\circ$

*2 E_e, E_V : Illuminance, irradiance by CIE standard light source A (tungsten lamp)

Fig. 1 Collector Power Dissipation vs. Ambient Temperature

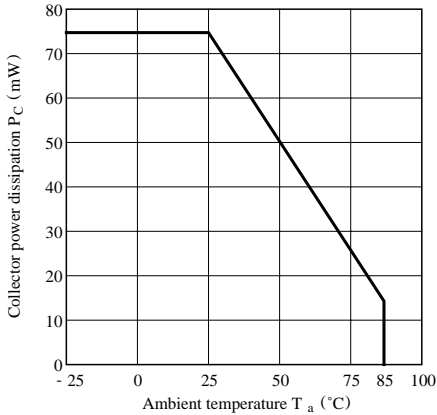

Fig. 2 Collector Dark Current vs. Ambient Temperature

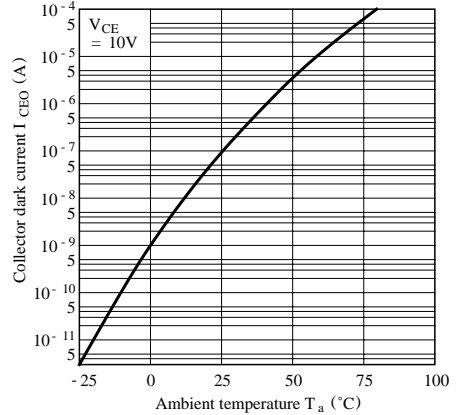

Fig. 3 Relative Collector Current vs. Ambient Temperature

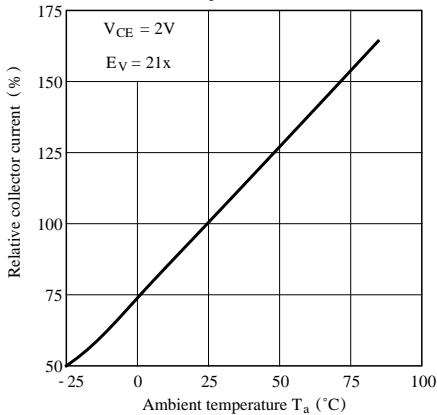

Fig. 4 Collector Current vs. Irradiance

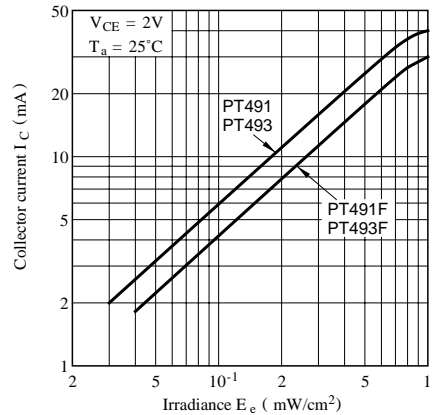

Fig. 5-a Collector Current vs. Collector-emitter Voltage (PT491/PT493)

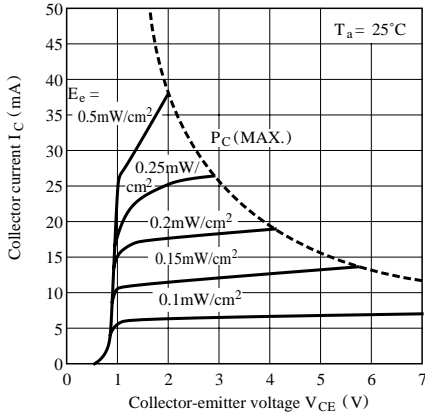

Fig. 5-b Collector Current vs. Collector-emitter Voltage (PT491F/PT493F)

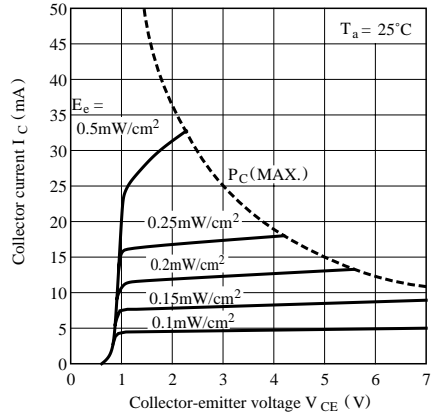

Fig. 6 Spectral Sensitivity

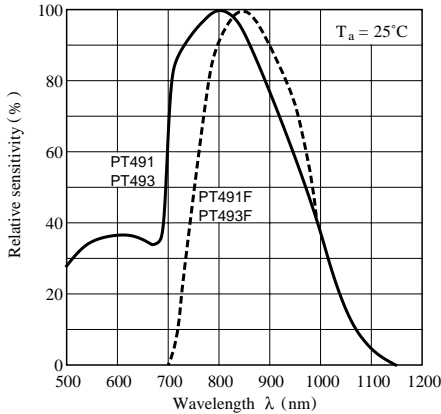
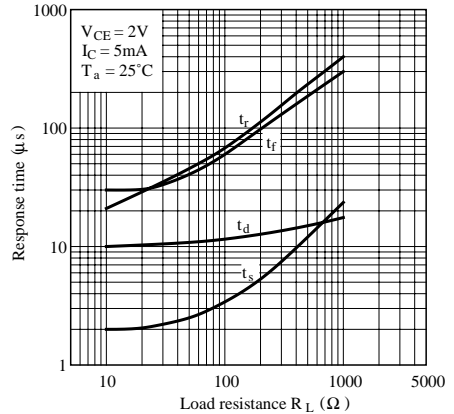

Fig. 7 Response Time vs. Load Resistance



Test Circuit for Response Time

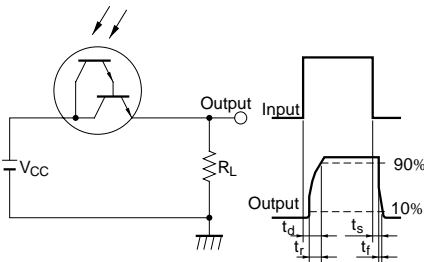

Fig. 8 Sensitivity Diagram (T_a = 25°C)

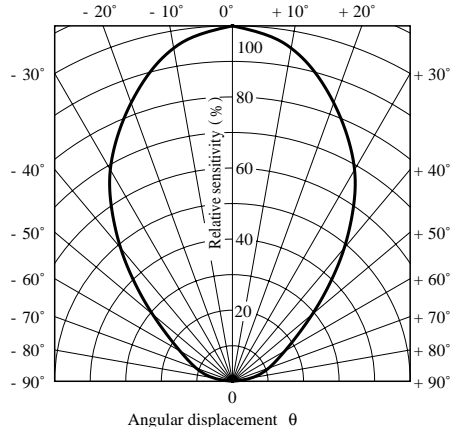

Fig. 9 Collector-emitter Saturation Voltage vs. Irradiance (PT491/PT493)

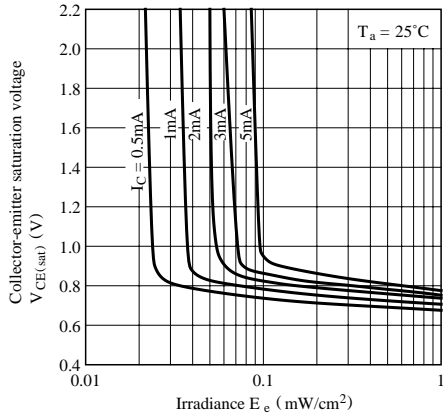
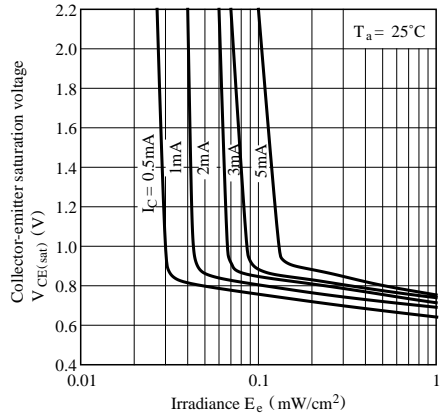

Fig.10 Collector-emitter Saturation Voltage vs. Irradiance (PT491F/PT493F)



Please refer to the chapter “Precautions for Use.”