

GP1L21/GP1L22

Subminiature, High Sensitivity Photointerrupter

■ Features

1. Ultra-compact (Capacity: 0.06cc)
2. High sensing accuracy
(Slit width: 0.3mm **GP1L22**)
3. High current transfer ratio
(CTR: MIN. 40% , **GP1L21**)
(MIN. 20% , **GP1L22**)
4. PWB direct mounting type
5. With mounting hole

■ Applications

1. Cameras
2. Floppy disk drives

■ Outline Dimensions

(Unit : mm)

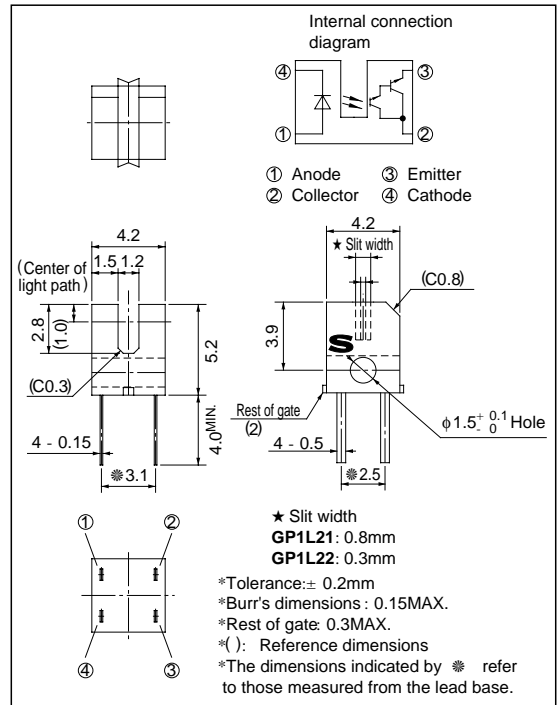

■ Absolute Maximum Ratings

(Ta = 25°C)

Parameter	Symbol	Rating	Unit	
Input	Forward current	I _F	50	mA
	Reverse voltage	V _R	6	V
	Power dissipation	P	75	mW
Output	Collector-emitter voltage	V _{CEO}	35	V
	Emitter-collector voltage	V _{ECO}	6	V
	Collector current	I _C	40	mA
	Collector power dissipation	P _C	75	mW
Total power dissipation	P _{tot}	100	mW	
Operating temperature	T _{opr}	- 25 to + 85	°C	
Storage temperature	T _{stg}	- 40 to + 100	°C	
*1 Soldering temperature	T _{sol}	260	°C	

*1 For 5 seconds

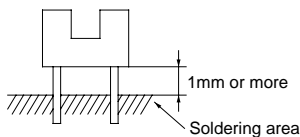

Electro-optical Characteristics

($T_a = 25^\circ\text{C}$)

Parameter		Symbol	Conditions	MIN.	TYP.	MAX.	Unit	
Input	Forward voltage	V_F	$I_F = 20\text{mA}$	-	1.2	1.4	V	
	Reverse current	I_R	$V_R = 3\text{V}$	-	-	10	μA	
Output	Collector dark current	I_{CEO}	$V_{CE} = 10\text{V}$	-	-	10^{-6}	A	
Transfer characteristics	Collector Current	GP1L21	$V_{CE} = 2\text{V}, I_F = 1\text{mA}$	0.4	-	15	mA	
		GP1L22		$V_{CE} = 2\text{V}, I_F = 1\text{mA}$	0.2	-	7	mA
	Collector-emitter saturation voltage	GP1L21	$V_{CE(sat)}$	$I_F = 2\text{mA}, I_C = 0.4\text{mA}$	-	-	1.0	V
		GP1L22		$I_F = 2\text{mA}, I_C = 0.2\text{mA}$	-	-	1.0	V
	Response time	Rise time	t_r	$V_{CE} = 2\text{V}, I_C = 10\text{mA}$	-	80	400	μs
Fall time		t_f	$R_L = 100\Omega$	-	70	350	μs	

Fig. 1 Forward Current vs. Ambient Temperature

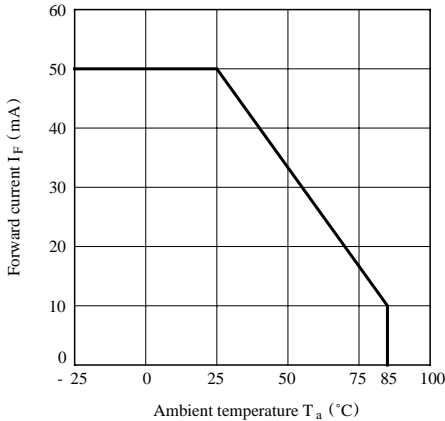

Fig. 2 Power Dissipation vs. Ambient Temperature

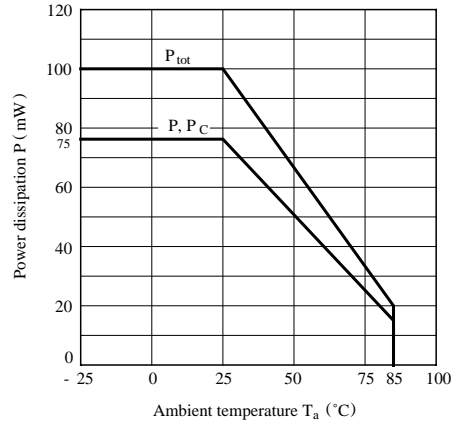

Fig. 3 Forward Current vs. Forward Voltage

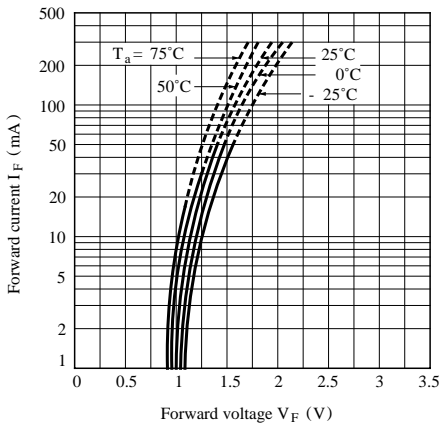

Fig. 4 Collector Current vs. Forward Current

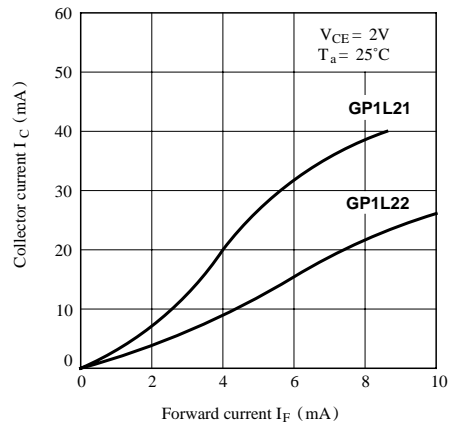

Fig. 5-a Collector Current vs. Collector-emitter Voltage (GP1L21)

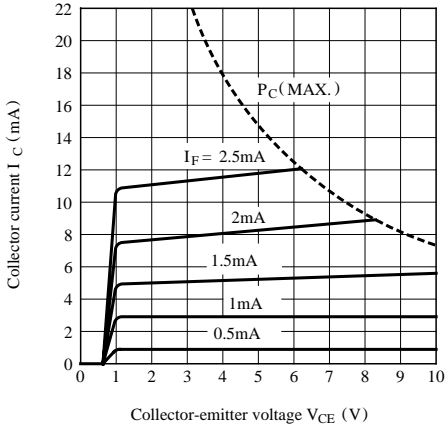

Fig. 5-b Collector Current vs. Collector-emitter Voltage (GP1S22)

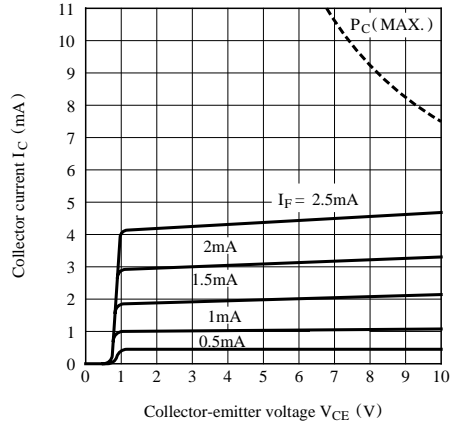

Fig. 6 Collector Current vs. Ambient Temperature

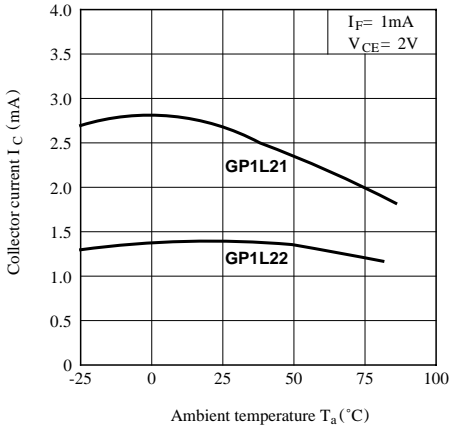

Fig. 7 Collector-emitter Saturation Voltage vs. Ambient Temperature

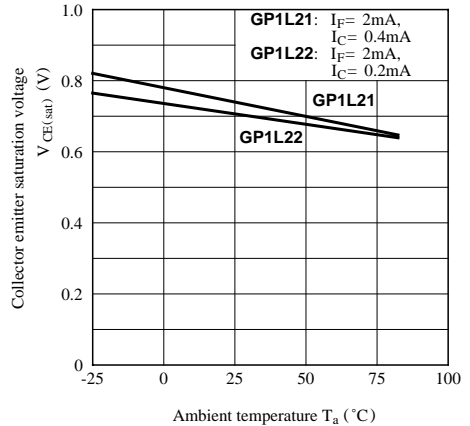
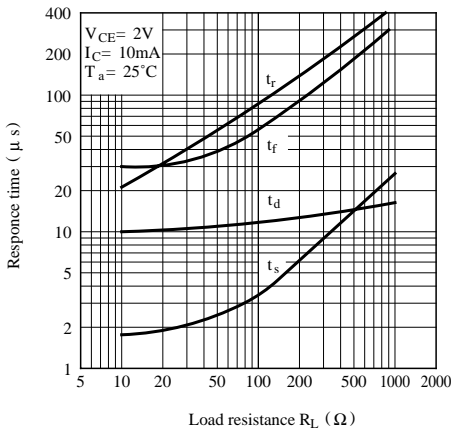

Fig. 8 Response Time vs. Load Resistance



Test Circuit for Response Time

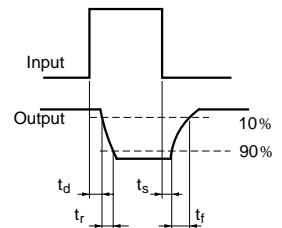
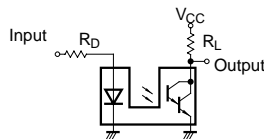

Fig. 9 Collector Dark Current vs. Ambient Temperature

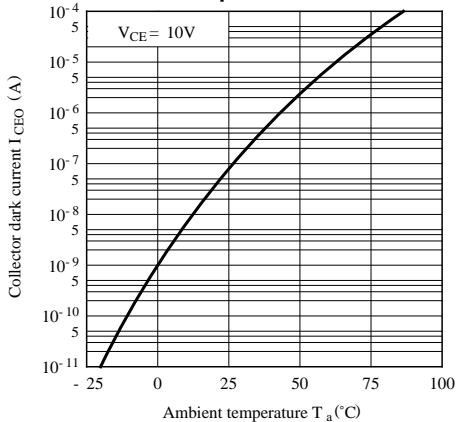

Fig.10-a Relative Collector Current vs. Shield Distance (1) (GP1L21)

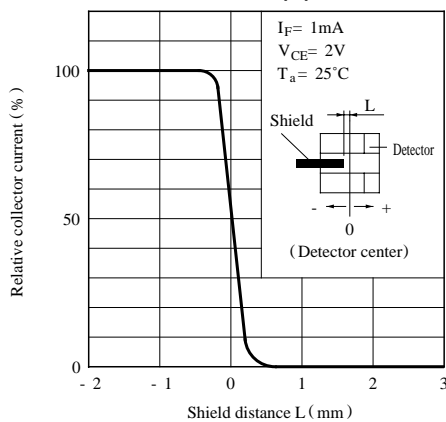

Fig.10-b Relative Collector Current vs. Shield Distance (1) (GP1L22)

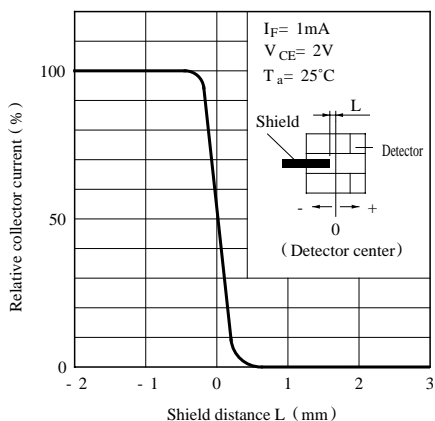
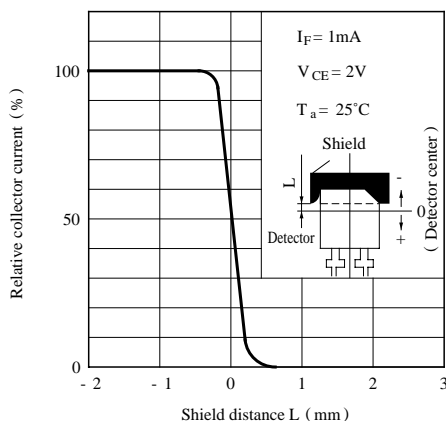

Fig.11 Relative Collector Current vs. Shield Distance (2)



● Please refer to the chapter “Precautions for Use”.