

LZ2346

Two-power supply (+5 V and +12 V) operation CCIR
1/3 type B/W CCD Area Sensor for CCIR

DESCRIPTION

LZ2346 is 1/3-type (6.0 mm) solid-state image sensor that consists of PN photo-diodes and CCDs (charge-coupled devices) driven by only positive voltages. Having approximately 220000 pixels (horizontal 384 × vertical 582), the sensor provides a stable B/W image.

FEATURES

- Number of pixels : 362 (H) × 582 (V)
Pixel pitch : 13.6 μm (H) × 6.3 μm (V)
Number of optical black pixels
: Horizontal; front 2 and rear 20
- Low fixed pattern noise and lag
- No sticking and no image distortion
- Blooming suppression structure
- Built-in output amplifier
- Variable electronic shutter (1/50 to 1/10 000 s)
- Compatible with CCIR standard
- Package : 16-pin SDIP[CERDIP](WDIP016-N-0500B)

PIN CONNECTIONS

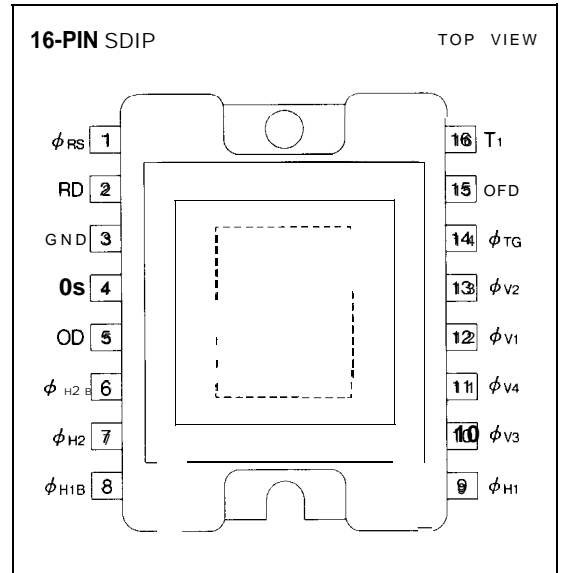

BLOCK DIAGRAM

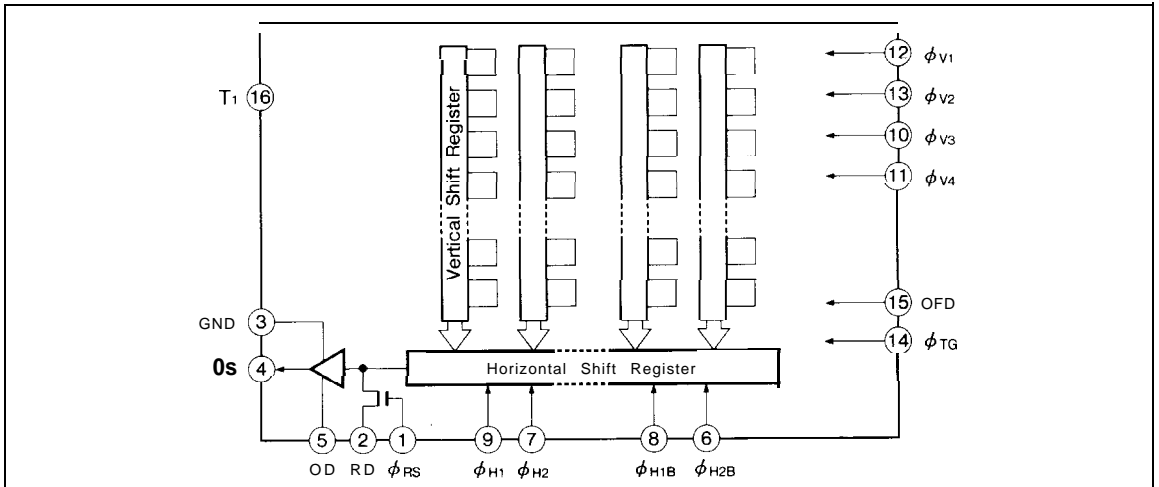

PIN DESCRIPTION

SYMBOL	PIN NAME
RD	Reset transistor drain
OD	Output transistor drain
Os	Video output
ϕ_{RS}	Reset transistor gate clock
$\phi_{V1}, \phi_{V2}, \phi_{V3}, \phi_{V4}$	Vertical shift register gate clock
$\phi_{H1}, \phi_{H2}, \phi_{H1B}, \phi_{H2B}$	Horizontal shift register gate clock
ϕ_{TG}	Transfer gate clock
OFD	Overflow drain
T ₁	Test terminal
GND	Ground

ABSOLUTE MAXIMUM RATINGS

(Ta = 25°C)

PARAMETER	SYMBOL	RATING	UNIT
Output transistor drain voltage	v _{OD}	0 to +1.5	v
Reset transistor drain voltage	V _{RD}	0 to +1.5	v
Test terminal, T ₁	V _{T1}	0 to +1.5	v
Reset gate clock voltage	V ϕ_{RS}	-0.3 to +15	v
Vertical shift register clock voltage	V ϕ_V	-0.3 to +15	v
Horizontal shift register clock voltage	V ϕ_H	-0.3 to +15	v
Transfer gate clock voltage	V ϕ_{TG}	-0.3 to +15	v
Overflow drain voltage	V _{OFD}	0 to +27	v
Storage temperature	T _{stg}	-40 to +85	°C
Operating ambient temperature	T _{opr}	-20 to +70	°C

RECOMMENDED OPERATING CONDITIONS

PARAMETER		SYMBOL	MIN.	TYP.	MAX.	UNIT	NOTE
Operating ambient temperature		T_{opr}		25.0		'c	
Output transistor drain voltage		V_{oo}	12.0	12.5	14.0	v	
Reset transistor drain voltage		V_{RD}		V_{oo}		v	
Overflow drain voltage	When DC is applied	V_{OFD}	3.0		12.0	v	1
	When pulse is applied p-p level	$V_{\phi OFD}$	12.0	12.5	14.0	v	2
Test terminal, T_1		V_{T1}		V_{oo}		v	
Ground voltage		GND		0.0		v	
Transfer gate clock	LOW level	$V_{\phi TGL}$	-0.05	0.0	0.05	v	
	HIGH level	$V_{\phi TGH}$	12.0	12.5	14.0	v	
Vertical shift register clock	LOW level	$V_{\phi V1-4L}$	-0.05	0.0	0.05	v	
	HIGH level	$V_{\phi V1-4H}$	4.7	5.0	6.0	v	
Horizontal shift register clock	LOW level	$V_{H1-2L}, V_{\phi H1B-2BL}$	-0.05	0.0	0.05	v	
	HIGH level	$V_{\phi H1-2H}, V_{B\phi H1B-2BH}$	4.7	5.0	6.0	v	
Reset gate clock	LOW level	$V_{\phi RSL}$	0.0		$V_{RD} - 10.5$	v	
	HIGH level	$V_{\phi RSH}$	$V_{RD} - 6.0$		9.5	v	
Vertical shift register clock frequency		$f_{\phi V1-4}$		15.63		kHz	
Horizontal shift register clock frequency		$f_{\phi H1-2}, f_{\phi H1B-2B}$		6.75		MHz	
Reset gate clock frequency		$f_{\phi RS}$		6.75		MHz	
Horizontal shift register clock phase		$tw1, tw2$	0.0	5.0	10.0	ns	3

NOTES :

1. When DC voltage is applied, shutter speed is 1 /50 seconds.
2. When pulse is applied, shutter speed is less than 1/50 seconds.

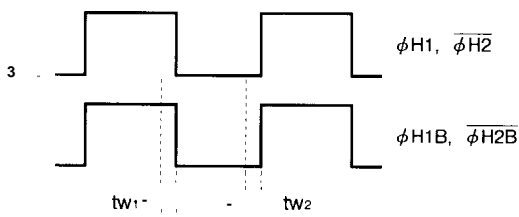

ELECTRICAL CHARACTERISTICS (Drive method : Field Accumulation)

(Ta = 25°C, Operating conditions : typical values for the recommended operating conditions, Color temperature of light source :3200 K / IR cut-off filter (CM-500, 1 mmt))

PARAMETER	SYMBOL	MIN.	TYP.	MAX.	UNIT	NOTE
Photo response non-uniformity	PRNU			15	%	2
Saturation signal	vast	450			mV	3
Dark output voltage	Vdark		5.0	15.0	mV	1, 4
Dark signal non-uniformity	DSNU		1.5	5.0	mV	1, 5
Sensitivity	R	140	200		mV	6
Smear ratio	SMR		- 85	- 76	dB	7
Image lag	AI			1.0	%	8
Blooming suppression ratio	ABL	1000				9
Output transistor drain current	I _{OD}		2.5	5.0	mA	
output impedance	R _o		400		Ω	

- The standard output voltage is defined as 150 mV by the average output voltage under uniform illumination.
- The standard exposure level is defined when the average output voltage is 150 mV under uniform illumination.

NOTES :

- 1 Ta : +60°C
- 2 The image area is divided into 10x 10 segments. The segment's voltage is the average output voltage of all the pixels within the segment. PRNU is defined by $(V_{max} - V_{min})/V_o$, where V_{max} and V_{min} are the maximum and the minimum values of each segment's voltage respectively, when the average output voltage V_o is 150 mV.
- 3 The image area is divided into 10x 10 segments. The saturation signal is defined as the minimum of each segment's voltage which is the average output voltage of all the pixels within the segment, when the exposure level is set as 10 times, compared to standard level.
- 4 The average output voltage under a non-exposure condition.
- 5 The image area is divided into 10x 10 segments. OSNU is defined by $(V_{dmax} - V_{dmin})$ under the non-exposure con-

dition where V_{dmax} and V_{dmin} are the maximum and the minimum values of each segment's voltage, respectively, that is the average output voltage over all pixels in the segment.

6. The average output voltage when a 1 COO lux light source attached with a 90% reflector is imaged by a lens of F4, f50 mm.
7. The sensor is adjusted to position a V/I O square at the center of image area where V is the vertical length of the image area. SMR is defined by the ratio of the output voltage detected during the vertical blanking period to the maximum of the pixel voltage in the V/I O square.
8. The sensor is exposed at the exposure level corresponding to the standard condition preceding non-exposure condition. AI is defined by the ratio between the output voltage measured at the 1st field during the non-exposure period and the standard output voltage.
- 9 The sensor is adjusted to position a V/I O square at the center of image area. ABL is the ratio between the exposure at the standard condition and the exposure at a point where a blooming is observed.

PIXEL STRUCTURE

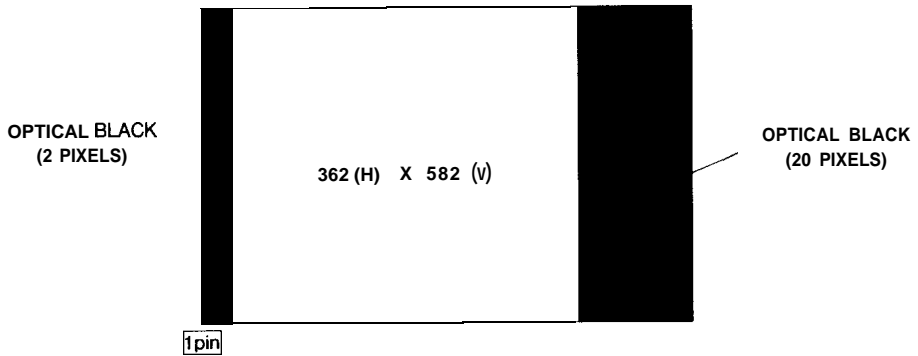

SPECTRAL RESPONSE EXAMPLE

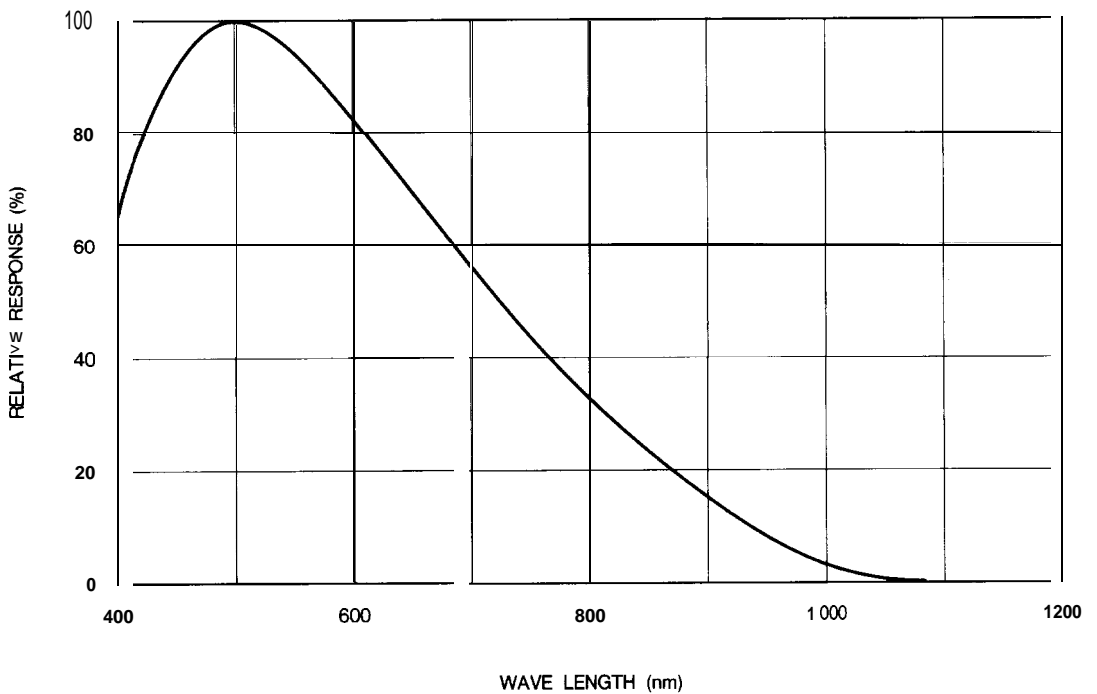

TIMING DIAGRAM EXAMPLE

VERTICAL TRANSFER TIMING

(1st, 3rd FIELD)

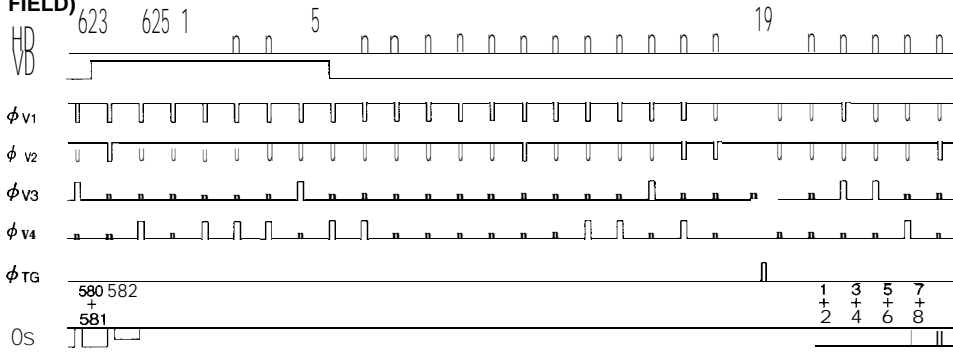

(2nd, 4th FIELD)

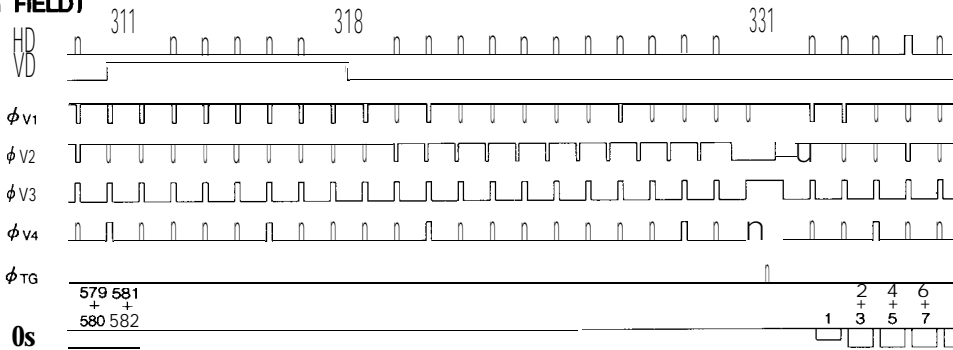

HORIZONTAL TRANSFER TIMING

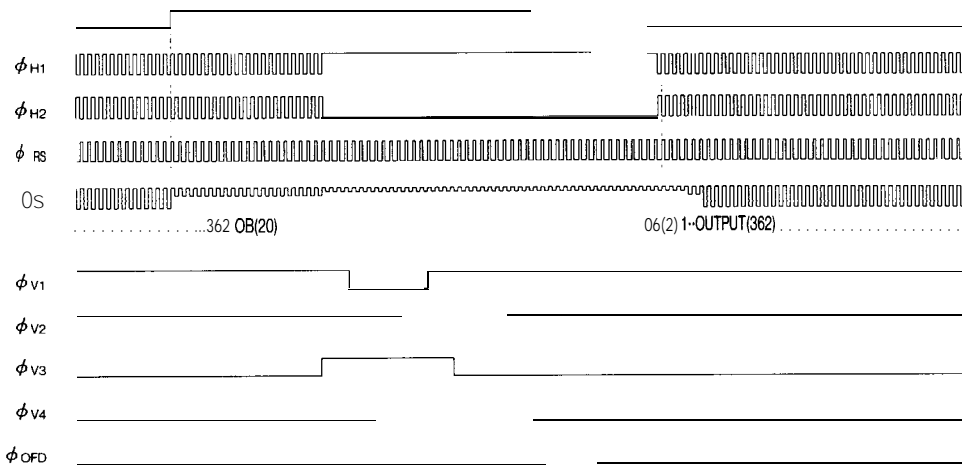

CCD REA SENSORS
2

READOUT TIMING

(1S, 3rd FIELD)

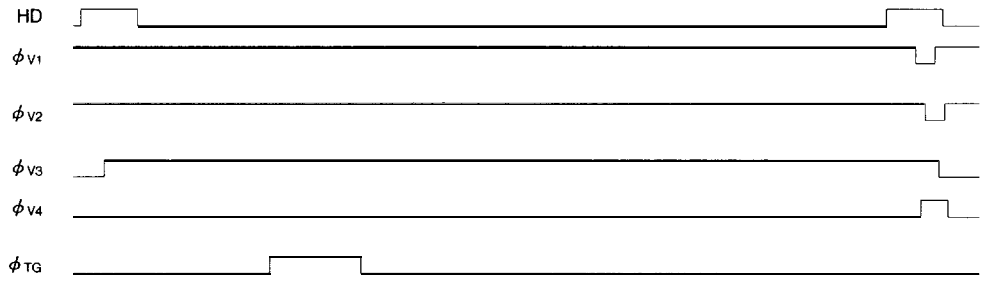

(2nd, 4th FIELD)

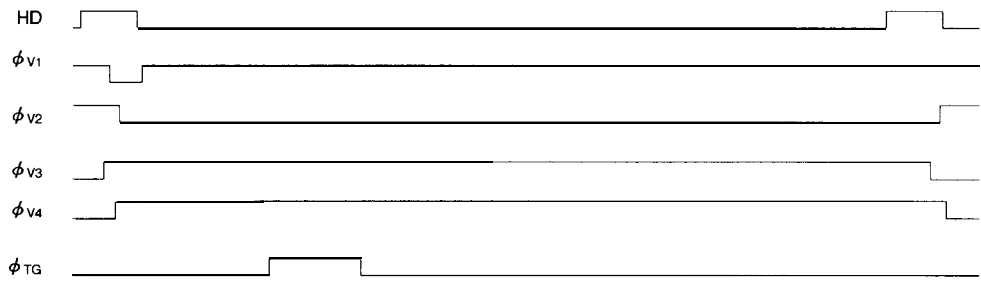

SYSTEM CONFIGURATION EXAMPLE

