

# SHARP

## LZ2547

Single-voltage (5 V) operation 1/5-type  
Color CCD Area Sensor for PAL

### Description

LZ2547 is a 1/5-type (3.6 mm) solid state imaging device driven by only 5 V single power supply.

Having about 220,000 pixels (horizontal 384 × vertical 582), it allows a stable color image.

### Features

1. Single-voltage (5 V) operation
2. Number of video picture elements : 362(H) × 582(V)  
Pixel pitch : 8.2 μm(H) × 3.8 μm(V)  
Number of optical back pixels : Horizontal; front 2 and rear 20
3. Compatible with PAL standard
4. Reduced fixed pattern noise and lag
5. No sticking and no image distortion
6. Blooming suppression structure
7. Built-in output amplifier, voltage generator, pulse mix circuit
8. Variable electronic shutter (1/50 to 1/10 000 s)
9. Package : 16-pin WDIP [Ceramic] Pin-pich 1.27 mm  
(WDIP016-N-0450)

### Pin Description

No.	Symbol	Pin name	Note
1	$\phi_{RS}$	Reset transistor gate clock	1
2	OS	Video output	
3	VD <sub>1</sub>	Voltage-generator output	2
4	OFD	Overflow drain	3
5	$\phi_{H2}$	Horizontal shift register gate clock	
6	$\phi_{H1}$	Horizontal shift register gate clock	
7	LOFX	Electronic shutter clock	
8	$\phi_{OFD}$	Electronic shutter clock	4
9	VD <sub>2</sub>	Voltage-generator output	2
10	$\phi_{TG}$	Transfer gate clock	
11	$\phi_{V1}$	Vertical shift register gate clock	5
12	$\phi_{V3}$	Vertical shift register gate clock	
13	$\phi_{V2}$	Vertical shift register gate clock	
14	$\phi_{V4}$	Vertical shift register gate clock	
15	V <sub>CC</sub>	Power supply	
16	GND	Ground	

### Pin Connections

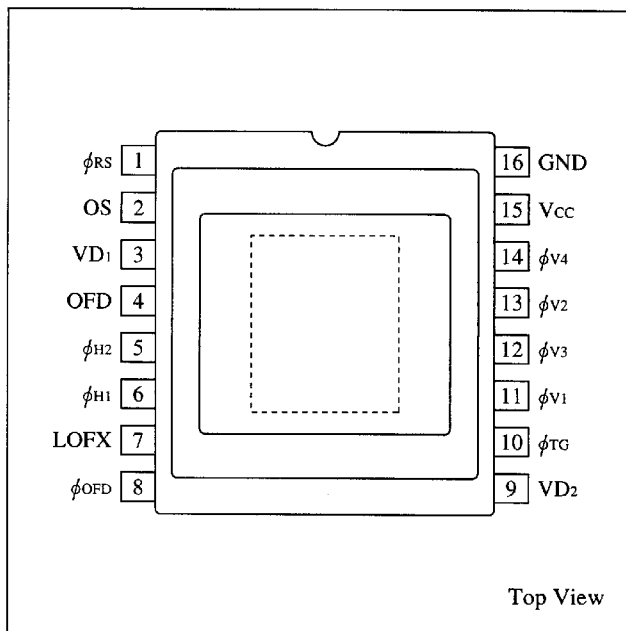

- Note 1.  $\phi_{RS}$  : Input the clock through a 0.1 μF capacitor.
- Note 2. VD<sub>1</sub>, VD<sub>2</sub> : Connect to GND through a 0.1 μF capacitor and a zener-diode (15.5 ± 0.5 V).  
VD<sub>1</sub> : Connect to GND through a 1 MΩ variable resistor.
- Note 3. OFD : Supply DC voltage with a following emitter-follower circuit (with a 1 MΩ emitter resistance).  
· Collector connects VD<sub>1</sub>  
· Emitter connects OFD through a diode  
· Base connects a 1 MΩ variable resistor
- Note 4.  $\phi_{OFD}$  : Connect to OFD through a diode and a 0.22 μF capacitor.
- Note 5.  $\phi_{V1}$ - $\phi_{V4}$  : Input the clock through a 0.1 μF capacitor.

## Absolute Maximum Ratings

(Ta=25 °C)

Parameter	Symbol	Rating	Unit
Power supply	V <sub>CC</sub>	0 to +7.3	V
Overflow drain voltage	V <sub>OFD</sub>	0 to +35	V
Reset gate clock P-P level	V <sub>φ RS</sub>	0 to +V <sub>CC</sub>	V
Vertical shift register clock P-P level	V <sub>φ v</sub>	0 to +V <sub>CC</sub>	V
Horizontal shift register clock voltage	V <sub>φ H</sub>	0 to +V <sub>CC</sub>	V
Transfer gate clock voltage	V <sub>φ TG</sub>	0 to +V <sub>CC</sub>	V
Electronic shutter clock voltage	V <sub>LOFX</sub>	0 to +V <sub>CC</sub>	V
Storage temperature	T <sub>stg</sub>	-40 to +85	°C
Operating ambient temperature	T <sub>opr</sub>	0 to +60	°C

## Recommended Operating Conditions

Parameter		Symbol	MIN.	TYP.	MAX.	Unit
Operating ambient temperature		T <sub>opr</sub>		25		°C
Power supply voltage		V <sub>CC</sub>	4.75	5.0	5.25	V
Overflow drain voltage	When DC is applied	V <sub>OFD</sub>	3.0	(adjust)	16	V
	When pulse is applied P-P level	V <sub>φ OFD</sub>			16	V
Ground voltage		GND		0		V
Reset gate clock	P-P level	V <sub>φ RS</sub>		V <sub>CC</sub>		V
Vertical shift register clock	P-P level	V <sub>φ v1</sub> , V <sub>φ v2</sub> , V <sub>φ v3</sub> , V <sub>φ v4</sub>		V <sub>CC</sub>		V
Horizontal shift register clock	LOW level	V <sub>φ H1L</sub> , V <sub>φ H2L</sub>		0		V
	HIGH level	V <sub>φ H1H</sub> , V <sub>φ H2H</sub>		V <sub>CC</sub>		V
Transfer gate clock	LOW level	V <sub>φ TGL</sub>		0		V
	HIGH level	V <sub>φ TGH</sub>		V <sub>CC</sub>		V
Electronic shutter clock	LOW level	V <sub>LOFXL</sub>		0		V
	HIGH level	V <sub>LOFXH</sub>		V <sub>CC</sub>		V
Vertical shift register clock frequency		f <sub>φ v1</sub> , f <sub>φ v2</sub> , f <sub>φ v3</sub> , f <sub>φ v4</sub>		15.63		kHz
Horizontal shift register clock frequency		f <sub>φ H1</sub> , f <sub>φ H2</sub>		6.75		MHz
Reset gate clock frequency		f <sub>φ RS</sub>		6.75		MHz

## ■ Electrical Characteristics

- Drive method : Field accumulation
- DC and AC conditions : The typical values under the recommended operating conditions.
- Ta=25 °C
- Temperature of light source : 3 200 K
- Infrared absorbing filter (CM-500, 1 mm) is used.

Parameter	Symbol	MIN.	TYP.	MAX.	Unit	Note
Standard output voltage	V <sub>o</sub>		150		mV	5
Photo response non-uniformity	PRNU			15	%	6
Saturation signal	V <sub>sat</sub>	450			mV	7
Dark output voltage	V <sub>dark</sub>		0.5		mV	4, 8
Dark signal non-uniformity	DSNU		0.5		mV	4, 9
Sensitivity	R		170		mV	10
Smear ratio	SMR		-85		dB	11
Image lag	AI			1.0	%	12
Blooming suppression ratio	ABL	1000				13
Current dissipation	I <sub>oD</sub>		4.0	8.0	mA	
Output impedance	R <sub>o</sub>		400		Ω	
Vector breakup				10	°, %	14
Line crawling				3.0	%	15
Luminance flicker				2.0	%	16

Note 4. Ta=60 °C

Note 5. The standard exposure level is defined when the average output voltage is 150 mV under uniform illumination.

Note 6. The image area is divided into 10×10 segments. The voltage of a segment is the average of output voltage from all the pixels within the segment.

PRNU is defined by  $(V_{max} - V_{min})/V_o$ , where  $V_{max}$  and  $V_{min}$  are the maximum and the minimum values of each segment's voltage respectively, when the average output voltage  $V_o$  is 150 mV.

Note 7. The image area is divided into 10×10 segments. The saturation signal is defined as the minimum of each segment's voltage which is the average of output voltage from all the pixels within the segment, when the exposure level is set as 10 times, compared to standard level.

Note 8. The average output voltage under a non-exposure condition.

Note 9. The image area is divided into 10×10 segments.

DSNU is defined by  $(V_{dmax} - V_{dmin})$  under the non-exposure condition where  $V_{dmax}$  and  $V_{dmin}$  are the maximum and the minimum values of each segment's voltage, respectively that is the average output voltage over all pixels in the segment.

Note 10. The average output voltage when a 1 000 lux light source attached with a 90% reflector is imaged by a lens of F4, f50 mm.

Note 11. The sensor is adjusted to position a V/10 square at the center of image area where V is the vertical length of the image area. SMR is defined by the ratio of the output voltage detected during the vertical blanking period to the maximum of the pixel voltage in the V/10 square.

Note 12. The sensor is exposed at the exposure level corresponding to the standard condition preceding non-exposure condition. AI is defined by the ratio between the output voltage measured at the 1st field during the non-exposure period and the standard output voltage.

Note 13. The sensor is adjusted to position a V/10 square at the center of image area. ABL is the ratio between the exposure at the standard condition and the exposure at a point where a blooming is observed.

Note 14. Observed with a vector scope when the color bar chart is imaged under the standard exposure condition.

Note 15. The difference between the average output voltage of the (Mg + Ye), (G + Cy) line and the (Mg + Cy), (G + Ye) line under the standard exposure condition.

Note 16. The difference between the average output voltage of the odd field and the even field.

※ The standard output voltage is defined as 150 mV by the average output voltage under uniform illumination.

■ Composition of Pixels and Arrangement of Color Filters

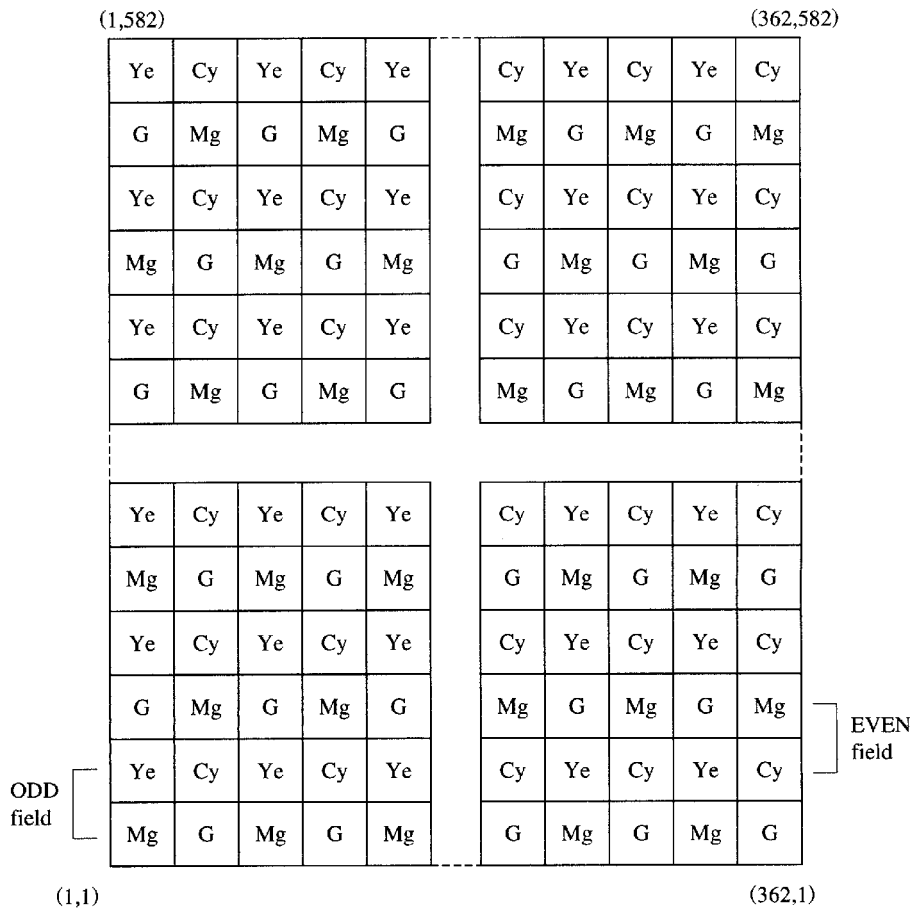
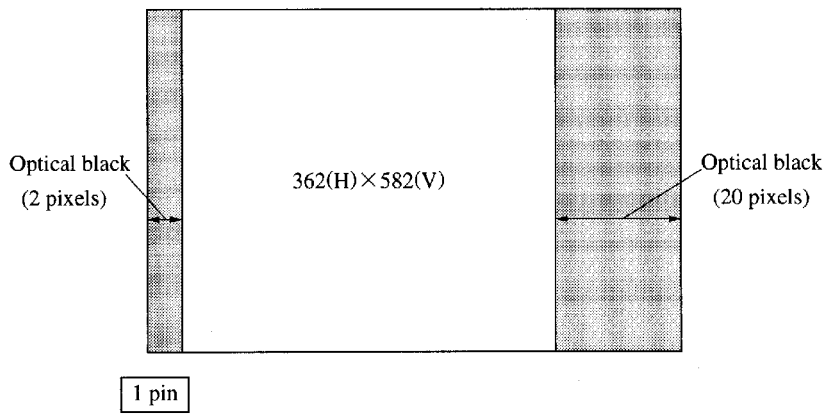

■ Timing Diagram

(1) Vertical Transfer Timing

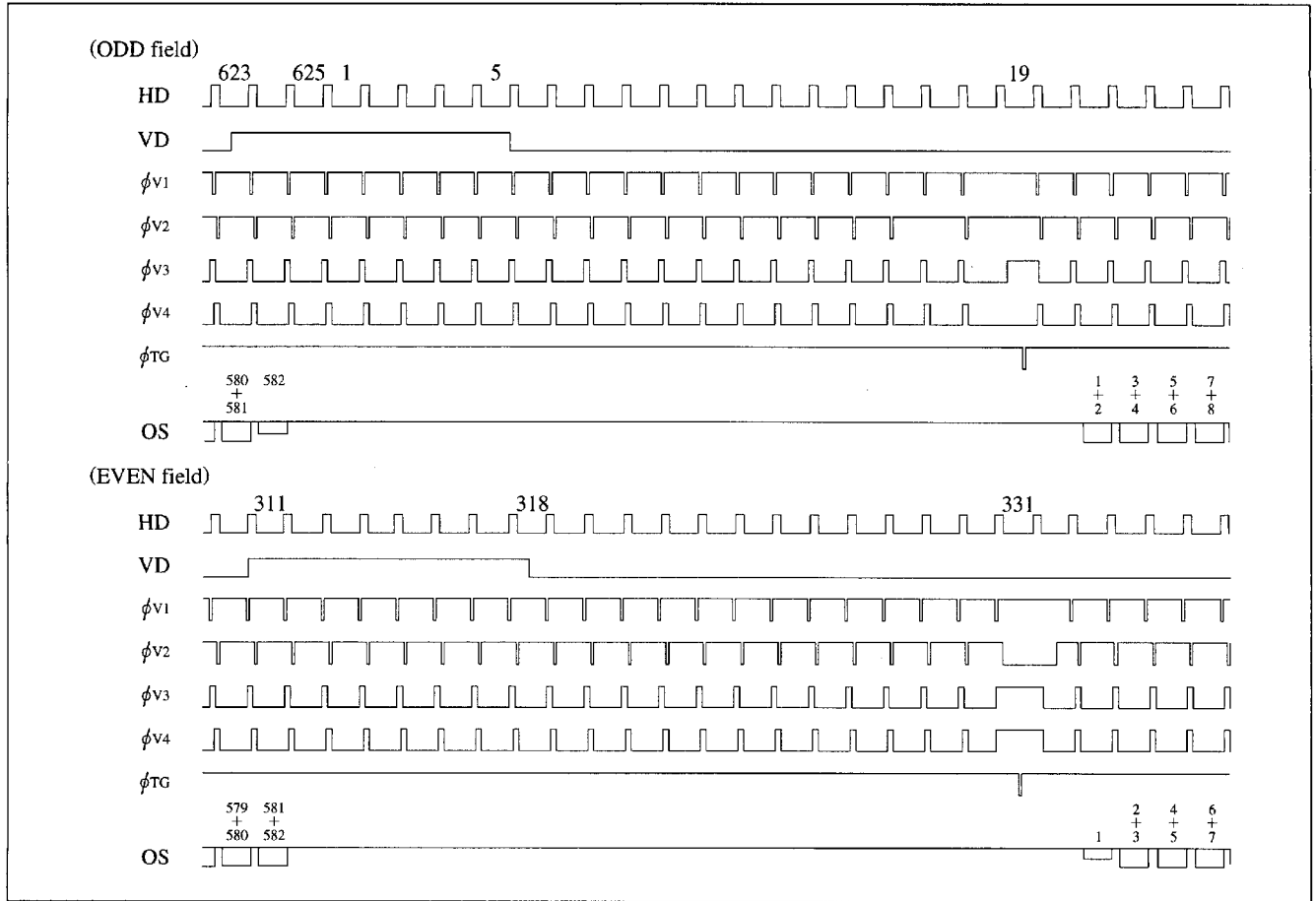

(2) Horizontal Transfer Timing

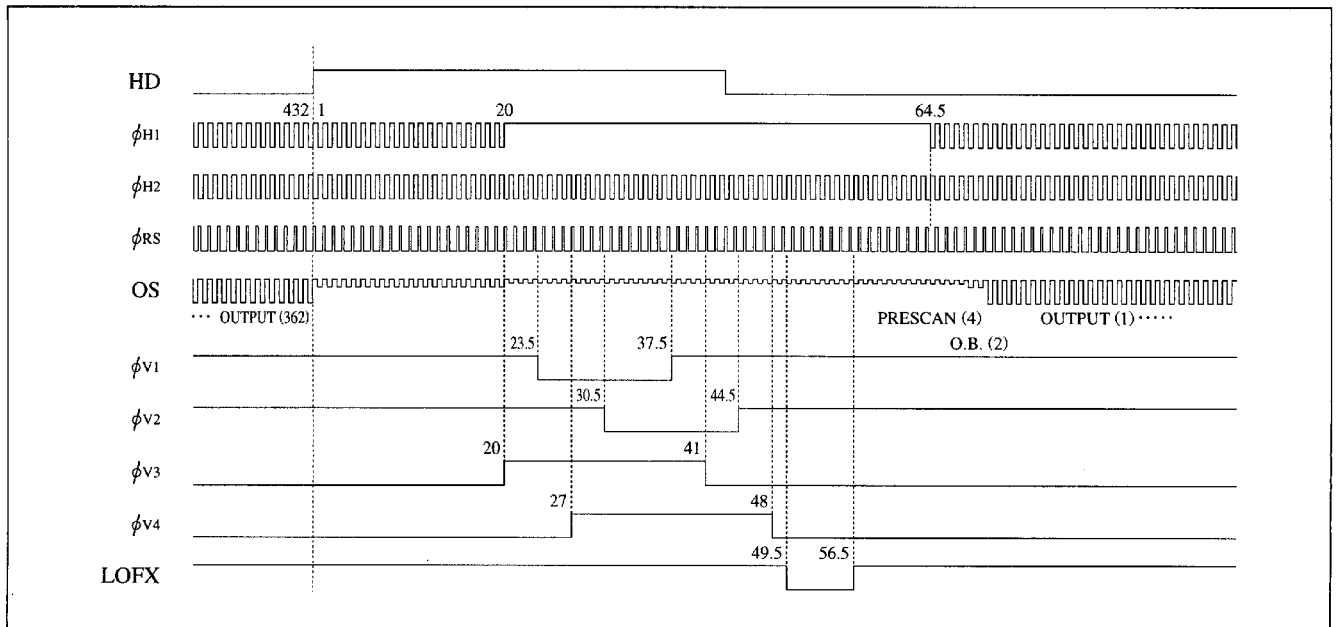

(3) Read Out Timing

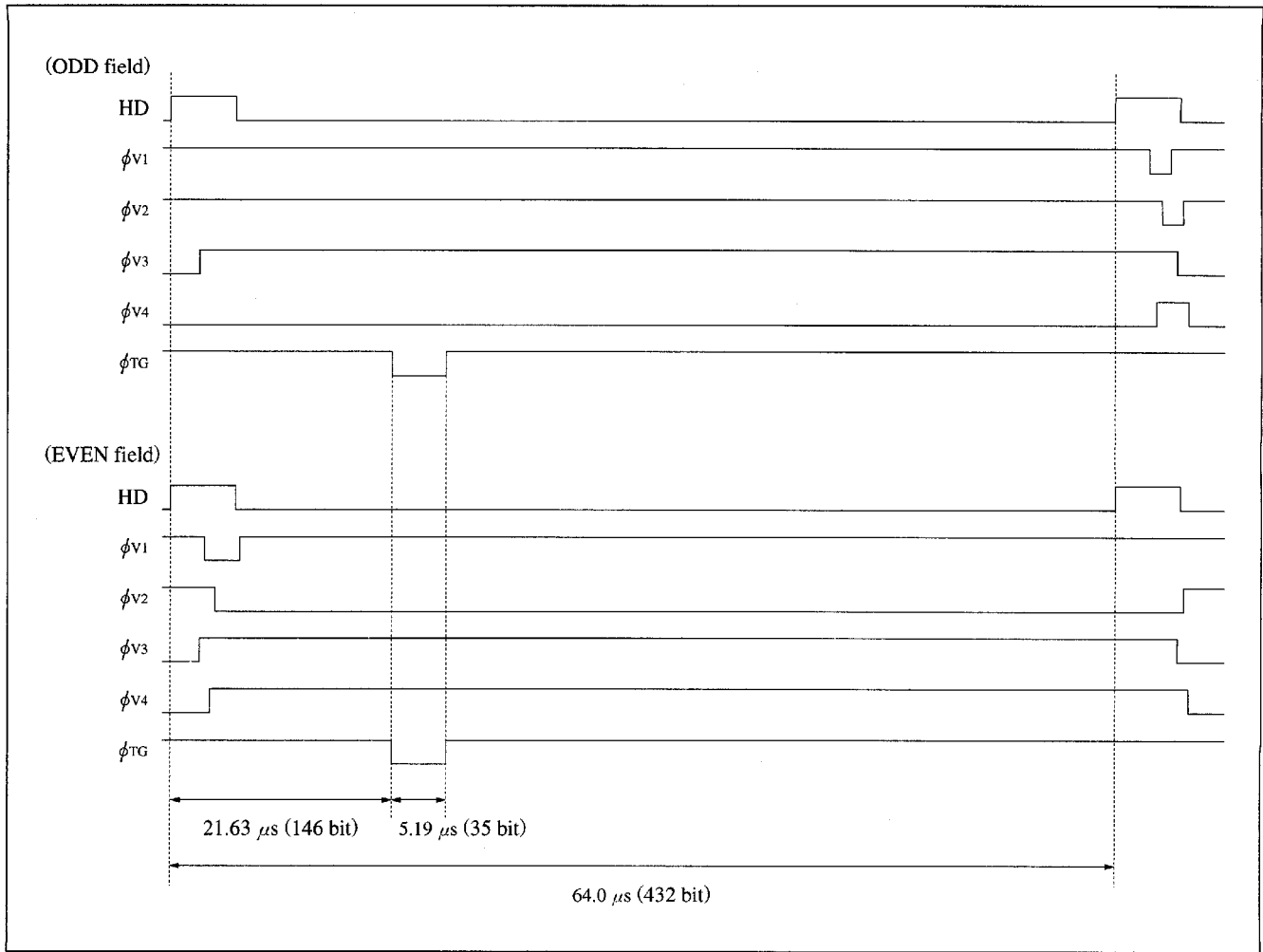

System Configuration Example

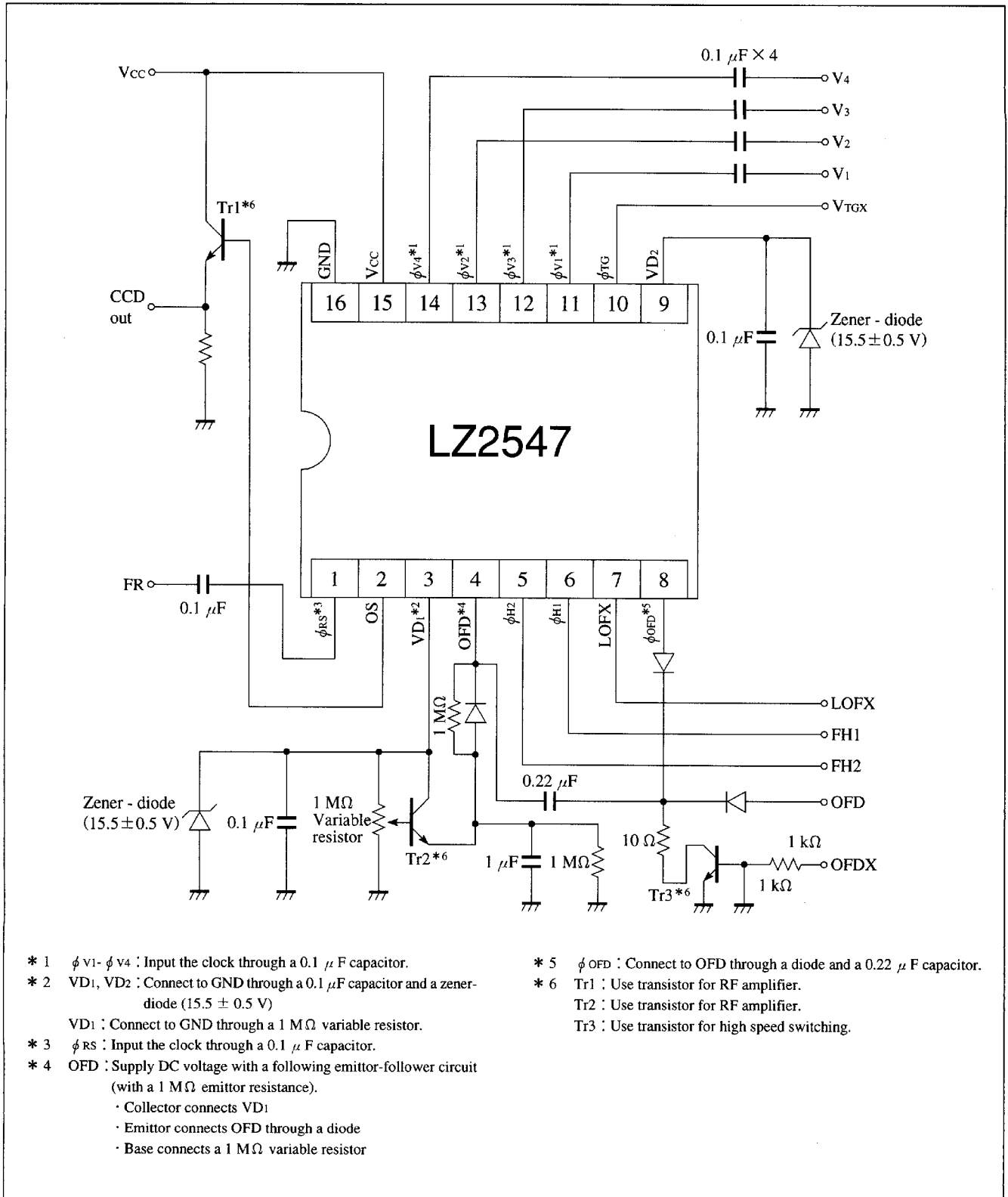

# SHARP

## SHARP CORPORATION Japan

### HEAD OFFICE

INTERNATIONAL SALES & MARKETING GROUP  
-IC/ELECTRONIC COMPONENTS  
22-22, NAGAIKE-CHO, ABENO-KU, OSAKA 545, JAPAN  
PHONE: (81) 6-621-1221  
FAX: 6117-725300, 6117-725301, 6117-725302

### IC SALES DEPARTMENT

INTERNATIONAL SALES & MARKETING GROUP  
-IC/ELECTRONIC COMPONENTS  
2613-1 ICHINOMOTO-CHO TENRI-CITY NARA 632, JAPAN  
PHONE: (81) 743-65-1321  
FAX: (81) 743-65-1532

## U.S.A.

### SHARP ELECTRONICS CORPORATION

#### Microelectronics Group

**North American Head Office**  
5700 Northwest Pacific Rim Blvd. #20,  
Camas, WA 98607  
PHONE: (1)360-834-2500  
FAX : (1)360-834-8903

**West**  
1980 Zanker Road, San Jose, CA 95112  
PHONE: (1)408-436-4900  
FAX : (1)408-436-0924

16841 Armstrong Avenue,  
Irvine, CA 92714  
PHONE: (1)714-250-0225  
FAX : (1)714-250-0438

1025 Royal Lane, DFW Airport,  
TX 75261-9035  
PHONE: (1)972-574-5205  
FAX : (1)972-574-9870

10222 Scull Creek, Austin, TX 78730  
PHONE: (1)512-349-7262  
FAX : (1)512-349-7002

9950 Cypresswood, Suite 350,  
Houston, TX 77070  
PHONE: (1)713-955-9909  
FAX : (1)713-955-9910

**East**  
1300 Naperville Road, Romeoville, IL 60441  
PHONE: (1)630-226-2400  
FAX : (1)630-759-8572

691 N. Squirrel Road, Suite 110,  
Auburn Hills, MI 48326  
PHONE: (1)810-377-9220  
FAX : (1)810-377-9222

14A Second Avenue, Burlington, MA 01803  
PHONE: (1)617-270-7979  
FAX : (1)617-229-9117

Canterbury Hall, 4815 Emperor Blvd.  
Suite 140, Durham, NC 27703  
PHONE: (1)919-941-0065  
FAX : (1)919-941-0066

## EUROPE

### SHARP ELECTRONICS (EUROPE) GmbH

**Head Office**  
Microelectronics Division, (MED)  
Sonninstrasse 3, 20097 Hamburg, Germany  
PHONE: (49)40-23 76 22 86  
FAX : (49)40-23 76 22 32

**Germany MED Stuttgart Office**  
Zettachring 8, 70567, Stuttgart, Germany  
PHONE: (49)711-90076-3  
FAX : (49)711-90076-50

**Germany MED Nürnberg Office**  
Donaustrasse 69, 90451 Nürnberg, Germany  
PHONE: (49)911-642 70 51  
FAX : (49)911-642 66 69

**France MED Paris Office**  
Immeuble Rosny 2, Avenue du  
Général de Gaulle 93110  
Rosny Sous Bois Cédex, France  
PHONE: (33)1-48 12 19 00  
FAX : (33)1-48 55 46 78

**Italy MED Milano Office**  
Centro Direzionale Colleoni  
Palazzo Taurus Ingresso 2  
20041 Agrate Brianza, Milano, Italy  
PHONE: (39)39-68 99 946  
FAX : (39)39-68 99 948

**U.K. MED London Office**  
Centennial Court, Easthampstead  
Road Bracknell, Berks RG12 1YQ,  
United Kingdom  
PHONE: (44)1344-86 99 22  
FAX : (44)1344-36 09 03

**U.K. MED Scotland Office**  
Unit 48 Grovedwood Business Centre,  
Strathclyde Business Park,  
Bellshill ML43NQ,  
Scotland, United Kingdom  
PHONE: (44)1698-84 34 42  
FAX : (44)1698-84 28 99

**Ireland MED Dublin Office**  
First Floor, Block 1, St. Johns Court  
Santry, Dublin 9, Ireland  
PHONE: (353)1-842 87 05  
FAX : (353)1-842 84 55

## ASIA

### SHARP-ROXY (HONG KONG) LTD.

3rd Business Division,  
17/F, Admiralty Centre,  
Tower 1, 18 Harcourt Road, Hong Kong  
PHONE: (852)28229311  
FAX : (852)28660779

### SHARP ELECTRONICS (SINGAPORE) PTE., LTD.

Electronic Components Division  
438A Alexandra Road #05-01/02  
Alexandra Technopark  
Singapore 119967  
PHONE: (65)271-3566  
FAX : (65)271-3855

### SHARP ELECTRONIC COMPONENTS (TAIWAN) CORPORATION

8Fl., No. 16, Sec. 4, Nanking E. Rd.,  
Taipei, Taiwan, Republic of China  
PHONE: (886)2-577-7341  
FAX : (886)2-577-7326, (886)2-577-7328

### SHARP ELECTRONIC COMPONENTS (KOREA) CORPORATION

RM 501 Geosung B/D, 541,  
Dohwa-dong, Mapo-ku, Seoul, Korea  
PHONE: (82)2-711-5813 to 5818  
FAX : (82)2-711-5819

The circuit application examples in this publication are provided to explain representative applications of SHARP devices and are not intended to guarantee any circuit design or license any intellectual property rights. SHARP takes no responsibility for any problems related to any intellectual property right of a third party resulting from the use SHARP devices.

SHARP reserves the right to make changes in the specifications, characteristics, data, materials, structures and other contents described herein at any time without notice in order to improve design or reliability. Contact SHARP in order to obtain the latest specification sheets before using any SHARP device. Manufacturing locations are also subject to change without notice.

In the absence of confirmation by device specification sheets, SHARP takes no responsibility for any defects that occur in equipment using any SHARP devices shown in catalogs, data books, etc.

Observe the following points when using any device in this publication. SHARP takes no responsibility for change caused by improper use of the devices, which does not meet the conditions and absolute maximum ratings for use specified in the relevant specification sheet nor meet the following conditions :

■ The devices in this publication are designed for use in general electronic equipment designs such as :

- Personal computers
- Office automation equipment
- Telecommunication equipment (except for trunk lines)
- Test and measurement equipment
- Industrial control
- Audio visual equipment
- Consumer electronics

■ Measures such as fail-safe function and redundant design should be taken to ensure reliability and safety when SHARP devices are used for or in connection with equipment that requires higher reliability such as :

- Main frame computers
- Transportation control and safety equipment (i.e. aircraft, trains, automobiles, etc.)

- Traffic signals
- Gas leakage sensor breakers
- Alarm equipment
- Various safety devices, etc.

■ SHARP devices shall not be used for or in connection with equipment that requires an extremely high level of reliability and safety such as :

- Military and aero space applications
- Telecommunication equipment (trunk lines)
- Nuclear power control equipment
- Medical and other life support equipment (e.g., scuba)

Contact a SHARP representative in advance when intending to use SHARP devices for any "specific" applications other than those recommended by SHARP or when it is unclear which category mentioned above controls the intended use.

If the SHARP devices listed in this publication fall in the scope of strategic products described in the Foreign Exchange and Foreign Trade Control Law, it is necessary to obtain export permission or approval under the law in order to export such SHARP devices.

This publication is the proprietary product of SHARP and copyrighted, with all rights reserved. Under the copyright laws, no part of this publication may be reproduced or transmitted in any form or by any means, electronic or mechanical, for any purpose, in whole or in part, without the express written permission of SHARP. Express written permission is also required before any use of this publication may be made by a third party.

Contact and consult with a SHARP representative if there are any questions about the contents of this publication.