

SHINDENGEN

Darlington Transistor

2SD2196
(TP15L20)

15A NPN

OUTLINE DIMENSIONS

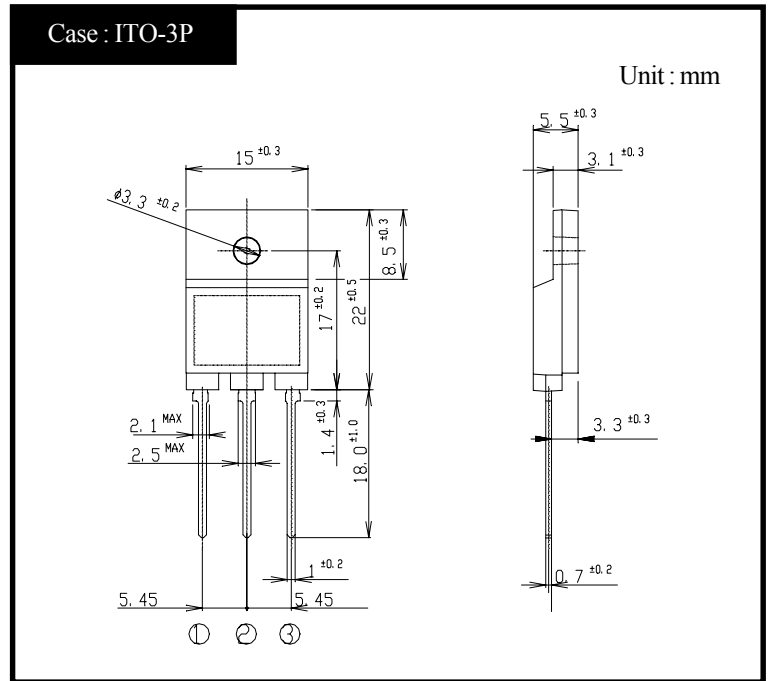

RATINGS

● Absolute Maximum Ratings

Item	Symbol	Conditions	Ratings	Unit
Storage Temperature	T _{stg}		-55~+150	°C
Junction Temperature	T _j		+150	°C
Collector to Base Voltage	V _{CB0}		200	V
Collector to Emitter Voltage	V _{CEO}		200	V
Emitter to Base Voltage	V _{EBO}		7	V
Collector Current DC	I _C		15	A
Collector Current Peak	I _{CP}		22	A
Base Current DC	I _B		1	A
Base Current Peak	I _{BP}		2	A
Total Transistor Dissipation	P _T	T _c = 25°C	65	W
Dielectric Strength	V _{dis}	Terminals to case AC 1 minute	2	kV
Mounting Torque	TOR	(Recommended torque : 0.5N·m)	0.8	N·m

● Electrical Characteristics (T_c=25°C)

Item	Symbol	Conditions	Ratings	Unit
Collector Cutoff Current	I _{CB0}	V _{CB} = 200V	Max 0.1	mA
	I _{CEO}	V _{CE} = 200V	Max 0.1	
Emitter Cutoff Current	I _{EBO}	V _{EB} = 7V	Max 5	mA
DC Current Gain	h _{FE}	V _{CE} = 3V, I _C = 10A	Min 1,500	
			Max 30,000	
Collector to Emitter Saturation Voltage	V _{CE(sat)}	I _C = 10A	Max 1.5	V
Base to Emitter Saturation Voltage	V _{BE(sat)}	I _B = 30mA	Max 2.0	V
Thermal Resistance	θ _{jc}	Junction to case	Max 1.92	°C/W
Transition Frequency	f _T	V _{CE} = 10V, I _C = 1.5A	TYP 20	MHz
Turn on Time	ton		Max 2	μs
Storage Time	ts	I _C = 10A I _{B1} = I _{B2} = 30mA R _L = 3 Ω	Max 12	
Fall Time	tf	V _{BB2} = 4V	Max 5	

2SD2196

$h_{FE} - I_C$

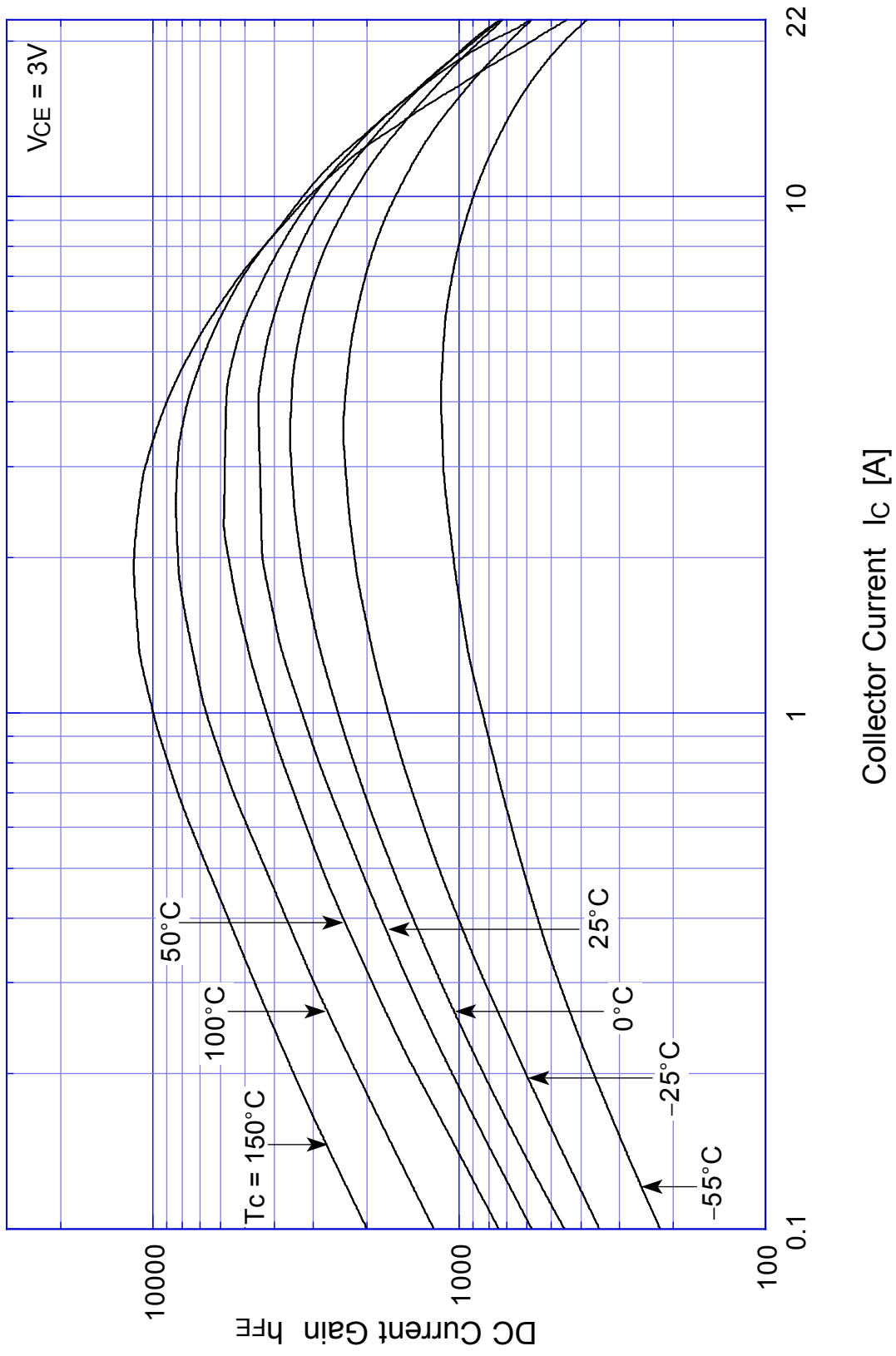

2SD2196

Switching Time - I_C

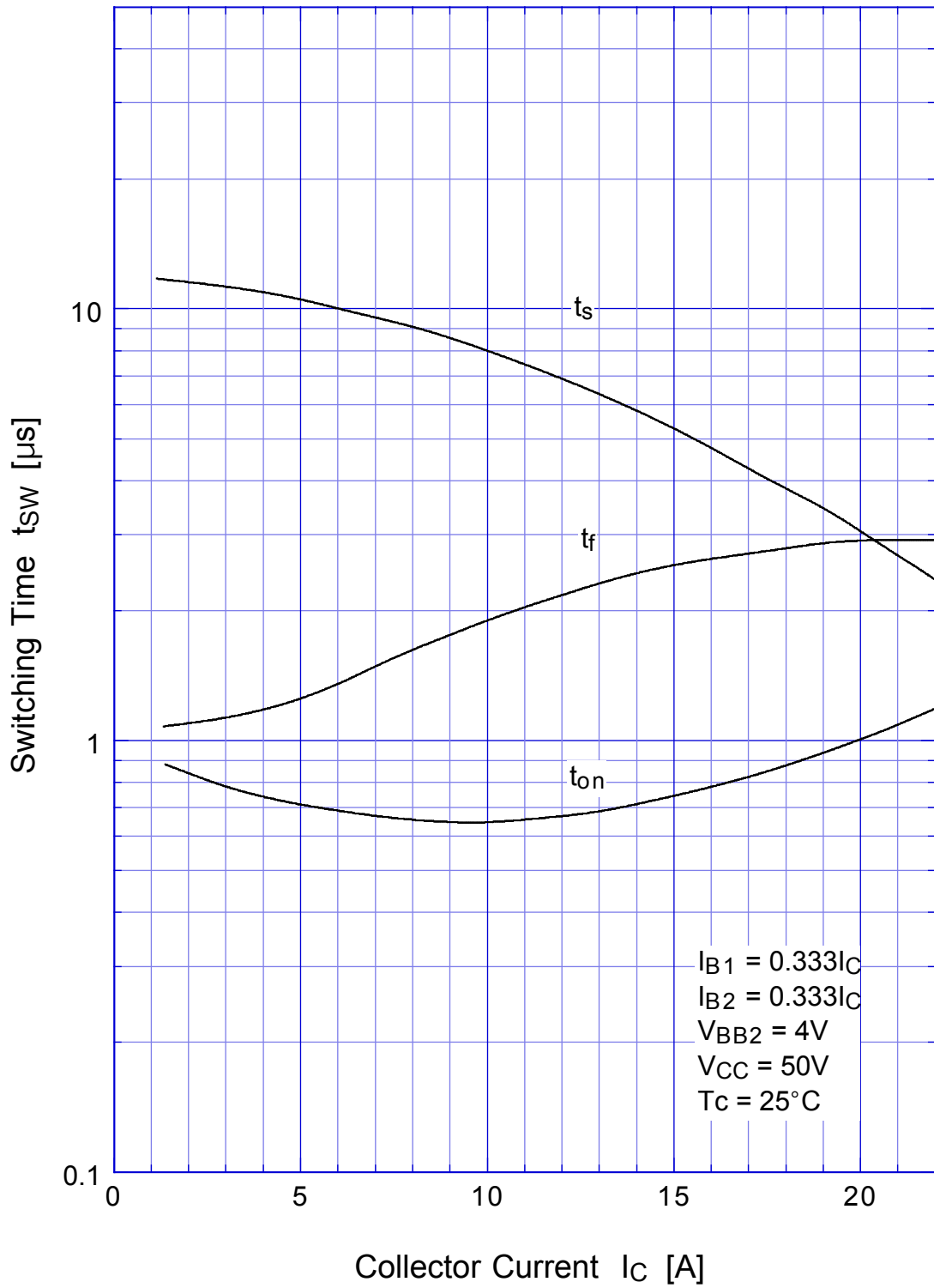

2SD2196

Switching Time

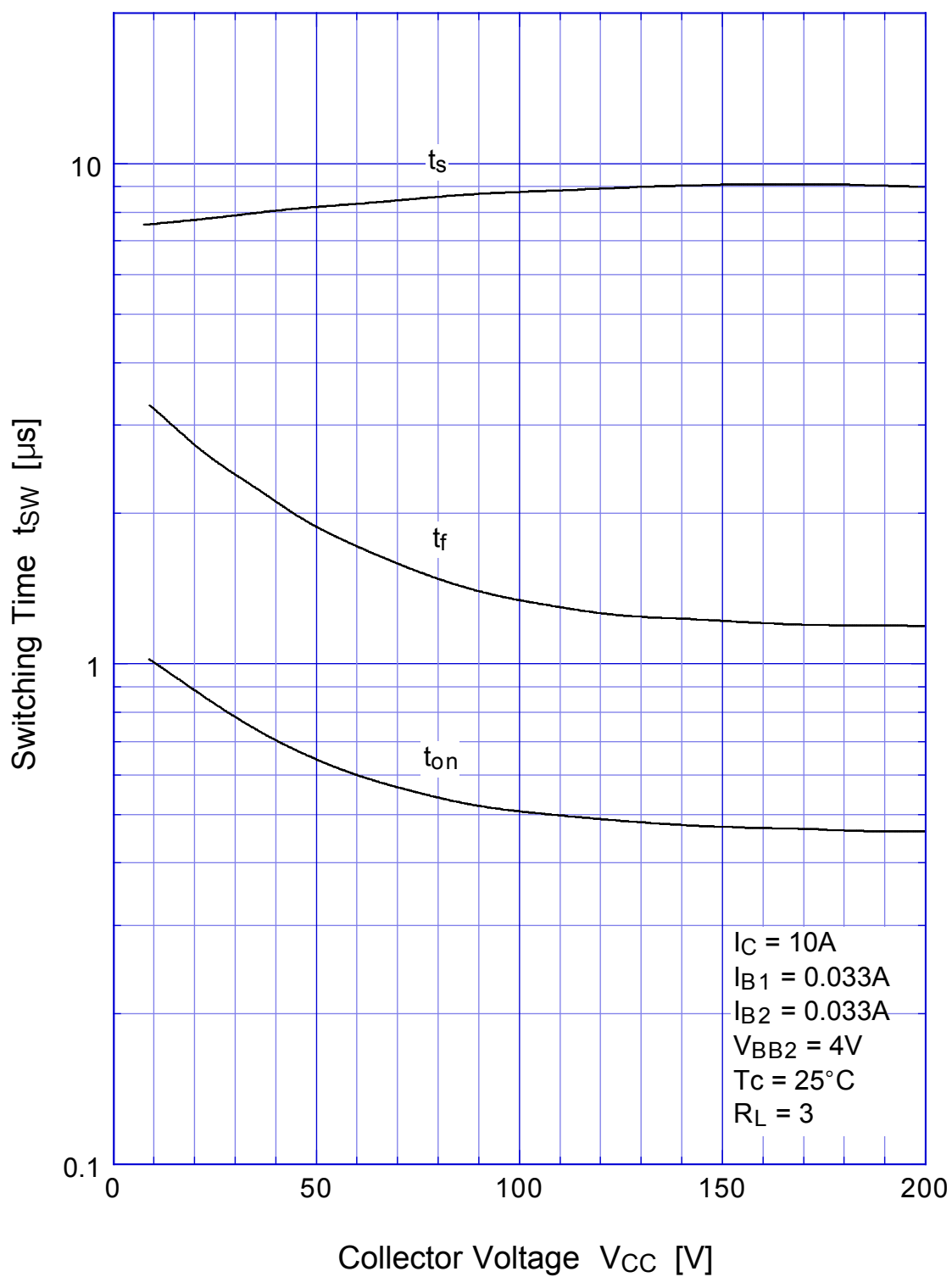

2SD2196

Switching Time - Tc

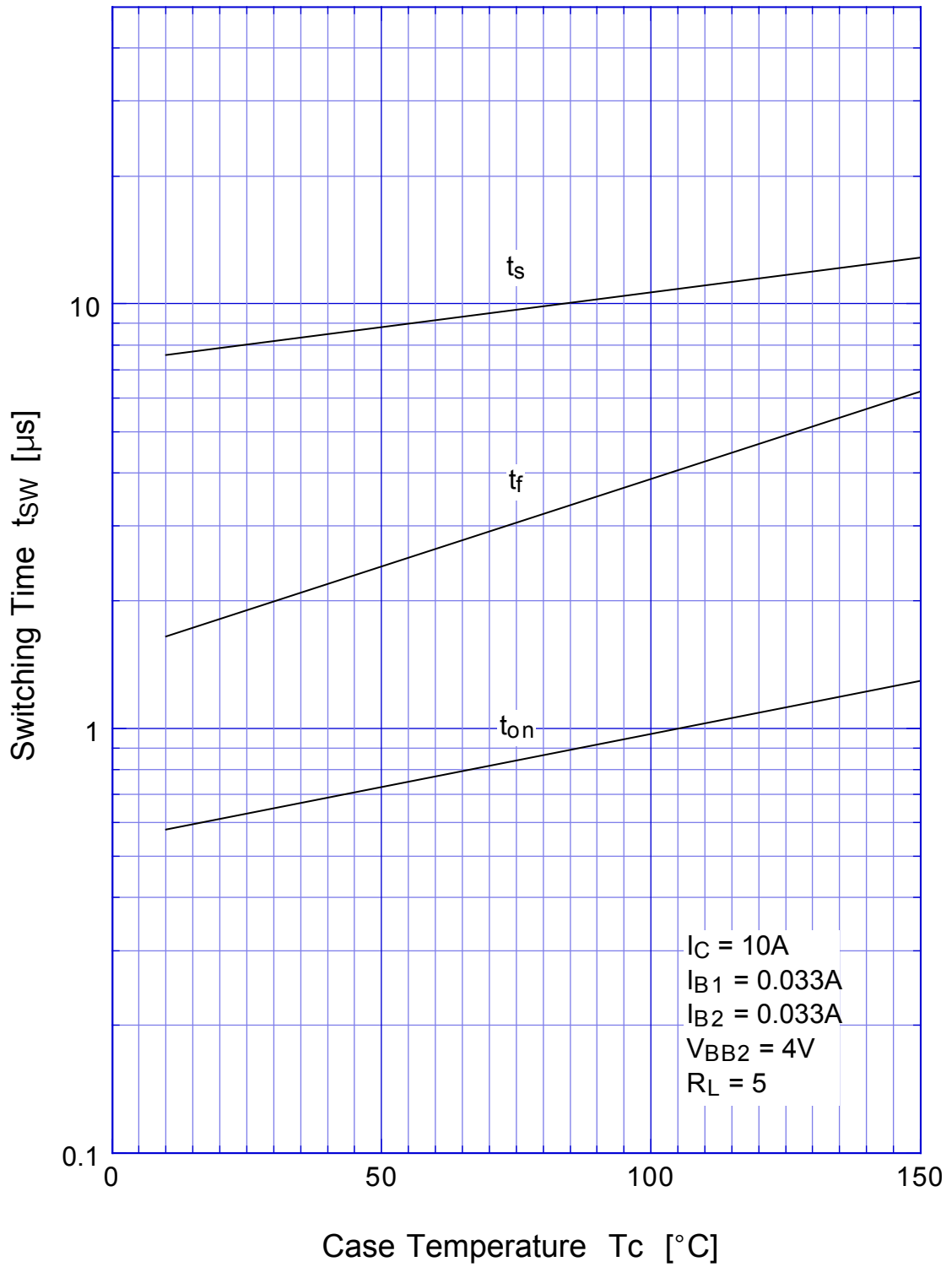

2SD2196 Transient Thermal Impedance

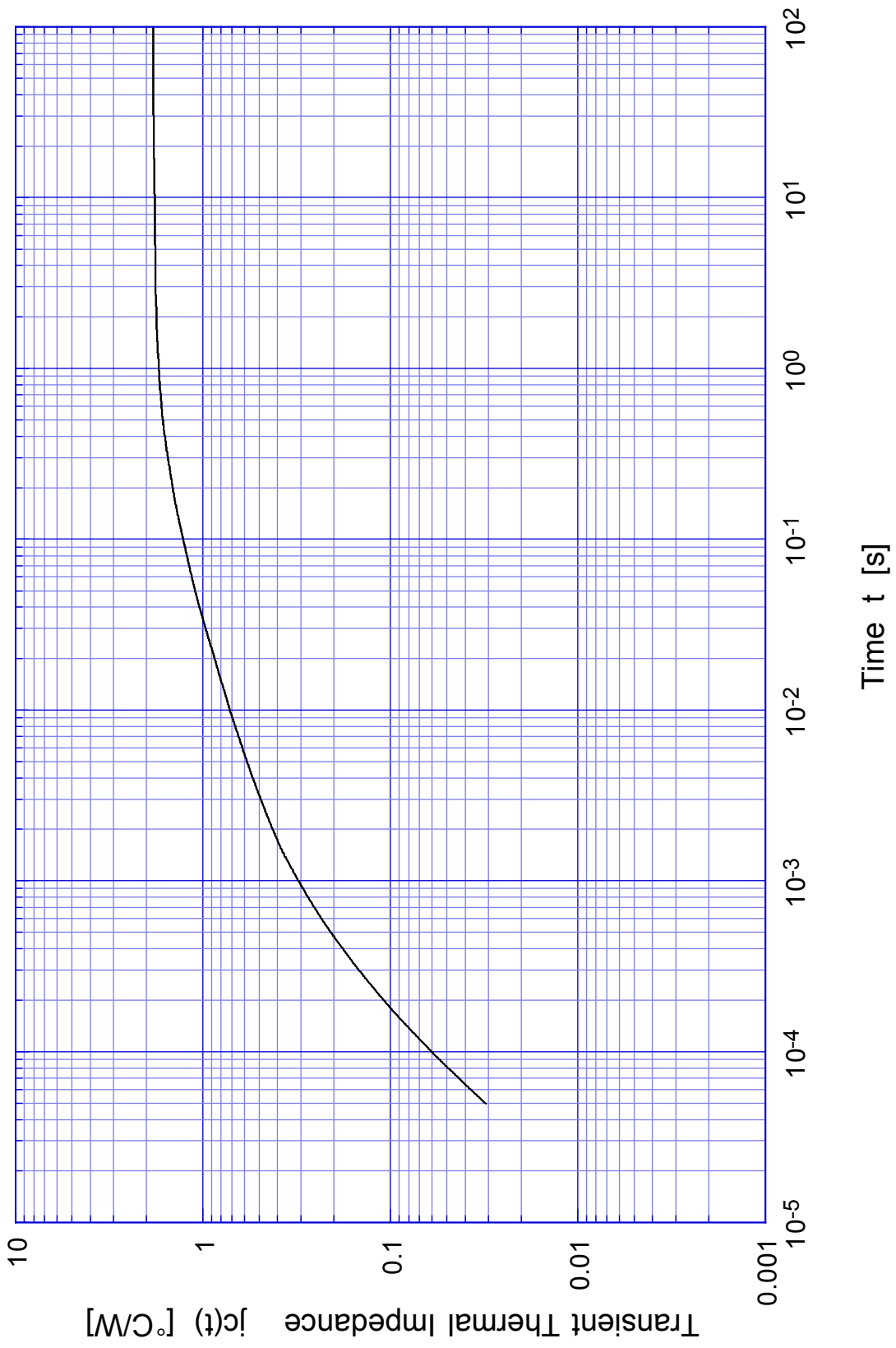

2SD2196

Forward Bias SOA

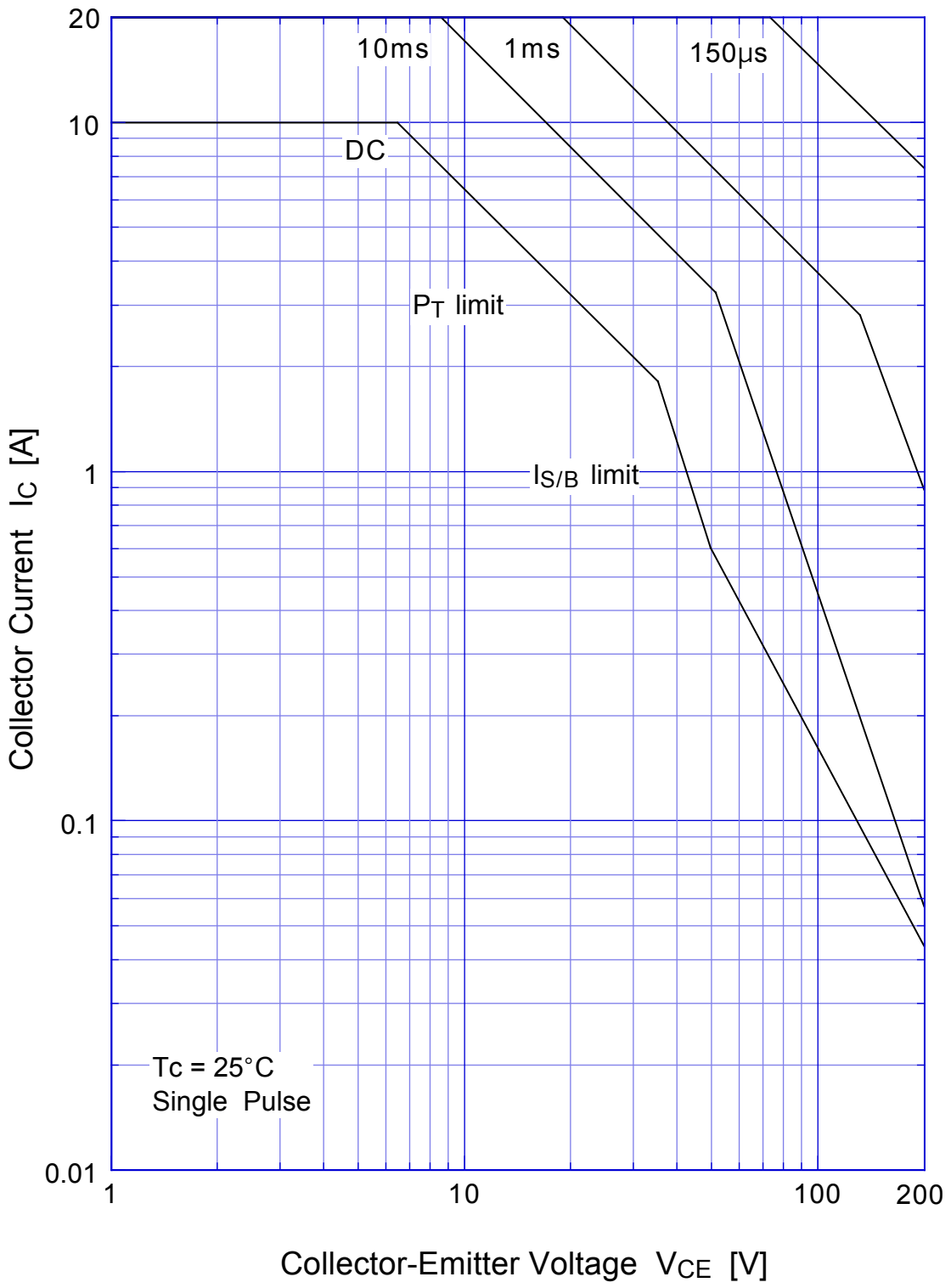

2SD2196 Collector Current Derating

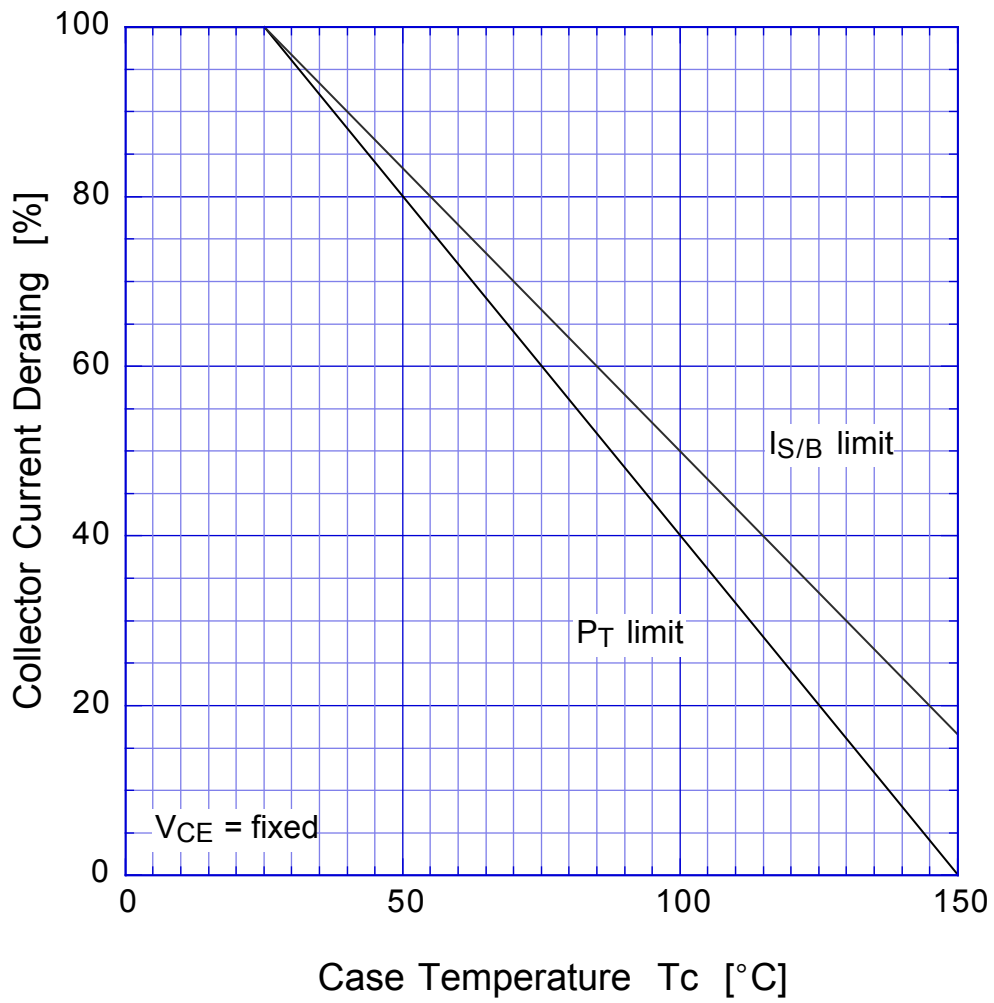

2SD2196

Reverse Bias SOA

